

S E R V I C E

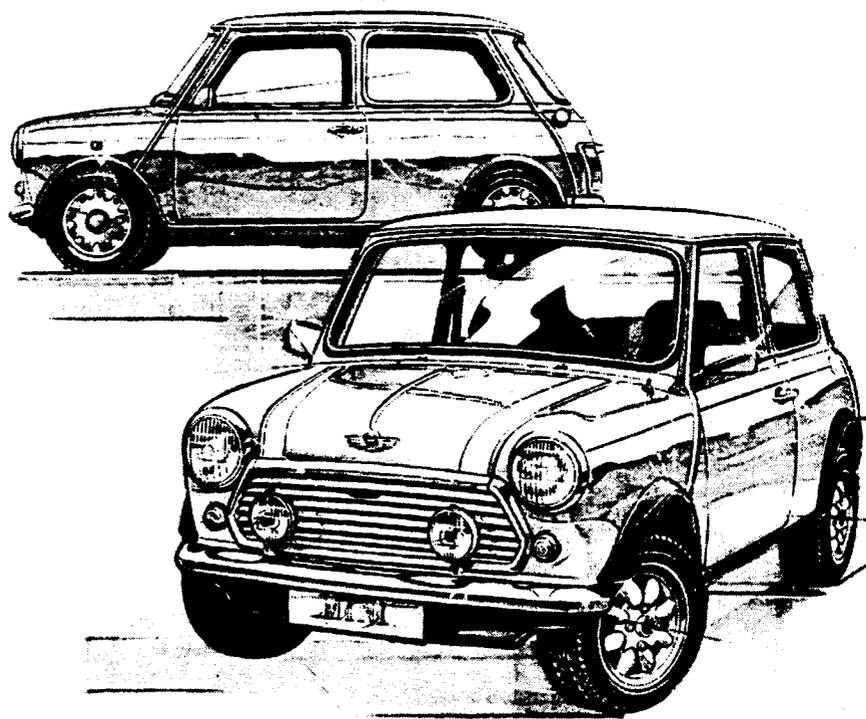

MINI

REPAIR MANUAL



SERVICE

MINI REPAIR MANUAL

This Repair Manual covers all Mini models manufactured from VIN 049349, and should be used in conjunction with the following manuals:

AKM 6845 - Mechanical Fault Finding Manual

AKM 7181 - Body Repair Manual

General Information,
General Data,
Engine tuning Data,
Capacities, Fluids and Lubricants



Maintenance



Engine



Carburettor & Ignition
MEMS - SPi
Fuel Delivery System



Cooling



Manifold & Exhaust



Clutch
Manual Gearbox
Automatic Gearbox
Drive Shafts
Differential



Steering



Suspension



Brakes



Body



Heating & Ventilation



Wipers and Washers
Electrical
Instruments



INTRODUCTION

INTRODUCTION

How to use this manual

To assist in the use of this manual the section title is given at the top and the relevant sub-section is given at the bottom each page.

Each section starts with a contents page, listing the information contained within. Some sections are divided into sub-sections such as Description and Operation, Adjustments, and Repairs. To assist filing of revised information each of the sub-sections is numbered from page 1.

The Adjustments and Repairs sub-sections are illustrated. The individual items comprising repair operations are to be followed in the sequence in which they appear. Items numbers in the illustration are referred to in the text.

Adjustment and Repair operations include reference to Service Tool numbers and the associated illustration depicts the tool. Where usage is not obvious the tool is shown in use. Adjustment and Repair operations also include reference to wear limits, relevant data, torque figures, and specialist information and useful assembly details. In the majority of cases, each Adjustment or Repair operation is given its Repair Operation Time number for reference.

WARNINGS, CAUTIONS and Notes have the following meanings:

WARNING: Procedures which must be followed precisely to avoid the possibility of injury.

CAUTION: Calls attention to procedures which must be followed to avoid damage to components.

Note: Gives helpful information.

References

References to the L.H. or R.H. side given in this manual are made when viewing the vehicle from the rear. With the engine and gearbox assembly removed, the crankshaft pulley end of the engine is referred to as the front.

Operations covered in this manual do not include reference to testing the vehicle after repair. It is essential that work is inspected and tested after completion and if necessary a road test of the vehicle is carried out particularly where safety related items are concerned.

Dimensions

The dimensions quoted are to design engineering specification with Service limits where applicable.

During the period of running – in from new, certain adjustments may vary from the specification figures given in this manual. These will be reset by the Dealer at the After Sales Service, and thereafter should be maintained at the figures specified in this manual.

REPAIRS AND REPLACEMENTS

When replacement parts are required it is essential that only Rover recommended parts are used.

Attention is particularly drawn to the following points concerning repairs and the fitting of replacement parts and accessories.

Safety features and corrosion prevention treatments embodied in the car may be impaired if other than Rover recommended parts are fitted. In certain territories, legislation prohibits the fitting of parts not to the manufacturer's specification. Torque wrench setting figures given in this Manual must be used. Locking devices, where specified, must be fitted. If the efficiency of a locking device is impaired during removal it must be renewed.

Owners purchasing accessories while travelling abroad should ensure that the accessory and its fitted location on the car conform to legal requirements.

The Terms of the vehicle Warranty may be invalidated by the fitting of other than Rover recommended parts.

All Rover recommended parts have the full backing of the vehicle Warranty.

Rover Dealers are obliged to supply only Rover recommended parts.

SPECIFICATION

Rover are constantly seeking to improve the specification, design and production of their vehicles and alterations take place accordingly. While every effort has been made to ensure the accuracy of this Manual, it should not be regarded as an infallible guide to current specifications of any particular vehicle.

This Manual does not constitute an offer for sale of any particular vehicle. Rover Dealers are not agents of Rover and have no authority to bind the manufacturer by any expressed or implied undertaking or representation.

ABBREVIATIONS AND SYMBOLS

After Bottom Dead Centre	A.B.D.C.	Metre	m
After Top Dead Centre	A.T.D.C.	Miles per hour	mph
Air conditioning	A/C	Millimetre	mm
Air fuel ratio	A.F.R.	Minimum	min
Alternating current	ac	Minus (of tolerance)	-
Amperes	A	Minute (angle)	'
Anti-lock brake system (Bosch)	ABS	Model Year	MY
Anti-lock brake system (Honda)	ALB	Modular engine management system	MEMS
Before Bottom Dead Centre	B.B.D.C.	Multi-point injection	MPi
Before Top Dead Centre	B.T.D.C.	Negative (electrical)	(-)
Bottom Dead Centre	B.D.C.	Newton metre	Nm
British Standards	B.S.	Number	No.
Carbon monoxide	CO	Outside diameter	o.dia.
Celsius (Centigrade)	C	Percentage	%
Centimetre	cm	Pint	pt
Chlorofluorocarbons	CFC's	Plus or minus	±
Compact Disc	C.D.	Plus (tolerance)	+
Cubic centimetres	cm ³	Positive (electrical)	+
Cubic inches	in ³	Positive crankcase ventilation	PCV
Cycles per minute	c/min	Positive temperature coefficient	PTC
Degree (angle)	deg. or °	Pounds mass	lb
Degree (temperature)	deg. or °	Radius	r
Dial test indicator	DTI	Ratio	:
Diameter	dia.	Reference	ref.
Direct current	dc	Revolutions per minute	rev/min
Electronic Control Unit	ECU	Right-hand	RH
Exhaust gas recirculation	EGR	Right-hand drive	RHD
Electronic air control valve	EACV	Rover Engineering Standards	RES
Fahrenheit	F	Second (angle)	"
Foot	ft	Second (numerical order)	2nd
Fifth	5th	Single carburettor	SC
First	1st	Single point injection	SPi
Fourth	4th	Specific gravity	sp.gr
Frequency Modulation	FM	Square centimetres	cm ²
Gallons (Imperial)	gal	Square inches	in ²
Gramme (mass)	g	Standard	std.
High compression	hc	Synchronizer/synchromesh	synchro
High tension (electrical)	ht	Third	3rd
Hour	h	Thousand	k
Inches	in	Top dead centre	TDC
Internal diameter	i.dia.	United Kingdom	UK
International Organization for Standardization	ISO	United States	US
Kilometre	km	Vehicle identification number	VIN
Kilogramme	kg	Volt	V
Kilohertz	kHz	Watt	W
Left-hand	LH		
Left-hand drive	LHD		
Light emitting diode	L.E.D.		
Litre	l		
Low Compression	lc		
Low tension	lt		
Maximum	max.		
Mercury	Hg		

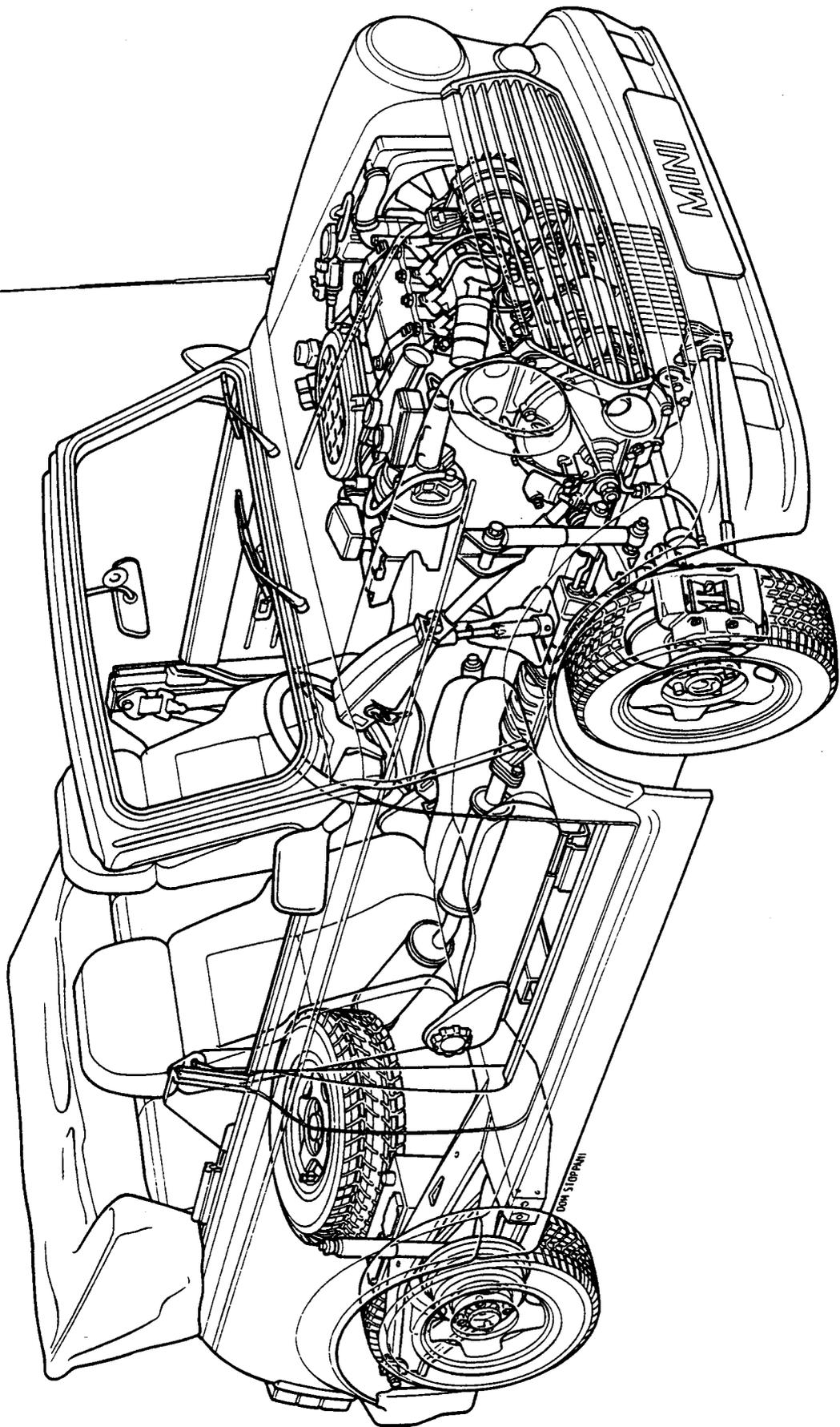

GENERAL INFORMATION



CONTENTS

Identification Numbers	Page
Identification numbers	2
Vehicle identification number plate	2
Engine number	2
Body number	2

General Precautions and Fitting Instructions	Page
General precautions	3
Ignition system safety precautions	3
Dangerous substances	3
Engine oils	3
Health protection precautions	3
Environmental protection precautions	3
Safety instructions	3
Jacking	3
Precautions against damage	3
Brake shoes and pads	4
Brake hydraulics	4
Engine coolant caps and plugs	4
Cleaning components	4
Joints and joint faces	4
Screw threads	4
Bolt identification	4
Nut identification	5
Locking devices	5
Oil seals	6
Service tools and garage equipment	6
Body repairs	6
Replacement body panels	6
Synthetic rubber	6

Fuel Handling Precautions	Page
Fuel handling precautions	7
General	7
Petrol - gasoline	7
Fuel tank draining	7
Fuel tank removal	7
Fuel tank repairs	7
Body and chassis repairs	7

Electrical Precautions	Page
Electrical precautions	8
Battery disconnecting	8
Battery charging	8
Disciplines	8
Grease for electrical connectors	8

GENERAL INFORMATION

IDENTIFICATION NUMBERS

Vehicle identification number

The Vehicle Identification Number (VIN) is stamped on a plate attached to the RH wing valance. As a deterrent to car thieves and to assist the police, the VIN is chemically etched on the windscreen and rear screen.

Vehicle identification number plate

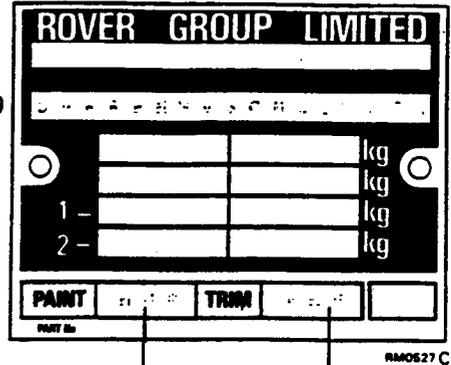
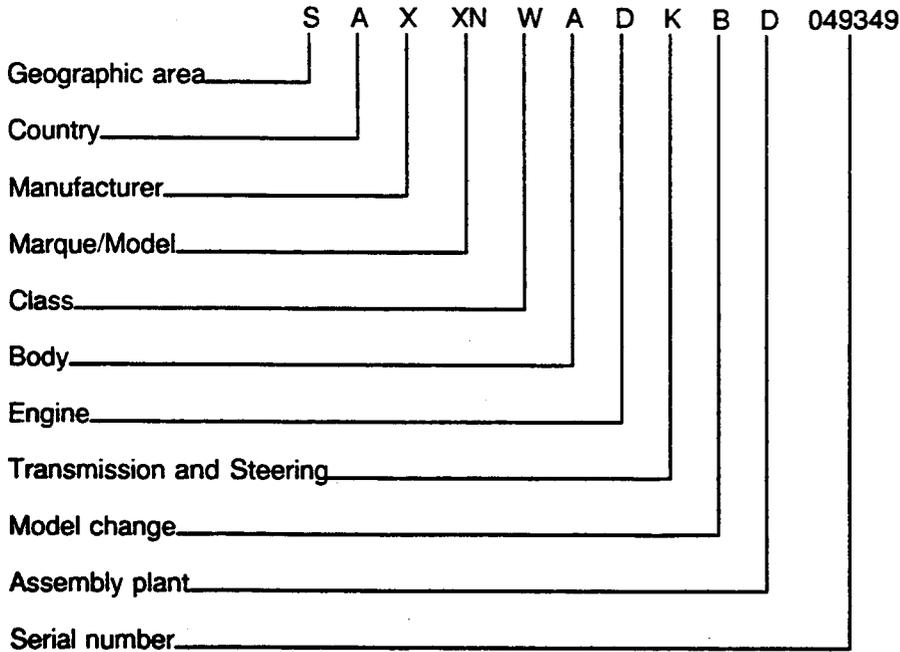

Paint and Trim colour codes

3 - letter codes identifying the original Paint and Trim colours are stamped on the VIN plate

Paint

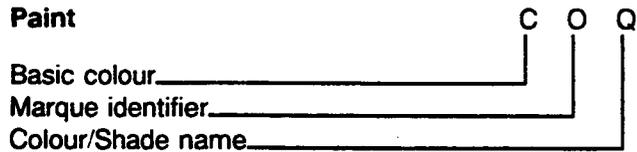

Trim



Engine number

Stamped on the front face of the cylinder block adjacent to the alternator.

Body number:

The body number is stamped on a plate fixed to the bonnet lock platform.



GENERAL PRECAUTIONS AND FITTING INSTRUCTIONS

Ignition system safety precautions

WARNING: Before commencing work on an ignition system, all high tension terminals, adapters and diagnostic equipment for testing should be inspected to ensure that they are adequately insulated and shielded to prevent accidental personal contacts and minimise the risk of shock. Wearers of surgically implanted pacemaker devices should not be in close proximity to ignition circuits or diagnostic equipment.

Dangerous substances

WARNING: Many liquids and other substances used in motor vehicles are poisonous and should under no circumstances be consumed and should, as far as possible, be kept from contact with the skin. These substances among others include acid, anti-freeze, asbestos, brake fluid, fuel, windscreen washer additives, lubricants, refrigerant and various adhesives.

Always read carefully the instructions printed on labels or stamped on components and obey them implicitly. Such instructions are included for reasons of your health and personal safety. Never disregard them.

Used engine oils: Prolonged exposure to used engine oils can cause serious skin disorders, avoid excessive skin contact and always adhere to the following recommendations:

Engine oils

Prolonged and repeated contact with mineral oil will result in the removal of natural fats from the skin, leading to dryness, irritation and dermatitis. In addition, used engine oil contains potentially harmful contaminants which may cause skin cancer. Adequate means of skin protection and washing facilities must be provided.

Health Protection Precautions

- Avoid prolonged and repeated contact with oils, particularly used engine oils.
- Wear protective clothing, including impervious gloves where practicable.
- Do not put oily rags in pockets.
- Avoid contaminating clothes, particularly underpants, with oil.
- Overalls must be cleaned regularly. Discard heavily soiled clothing and oil impregnated footwear.
- First aid treatment should be obtained immediately for open cuts and wounds.

- Use barrier creams, applying before each work period, to help the removal of oil from the skin.
- Wash with soap and water to ensure all oil is removed (skin cleansers and nail brushes will help). Preparations containing lanolin replace the natural skin oils which have been removed.
- Do not use petrol, kerosene, diesel fuel, gas oil, thinners or solvents for cleaning skin.
- If skin disorders develop, obtain medical advice without delay.
- Where practicable, degrease components prior to handling.
- Where there is a risk of eye contact, eye protection should be worn, for example, chemical goggles or face shields; in addition an eye wash facility should be provided.

Environmental Protection Precautions

It is illegal to pour used oil on to the ground, down sewers or drains, or into water courses.

Burning of used engine oil in small space heaters or boilers can be recommended only for units of approved design. The heating system must meet the regulatory standards of HMIP for small burners of less than 0.4 MW. If in doubt check with the appropriate local authority and/or manufacturer of approved appliance.

Dispose of used oil and used filters through authorised waste disposal contractors to licensed waste disposal sites, or to the waste oil reclamation trade. If in doubt, contact the Local Authority for advice on disposal facilities.

SAFETY INSTRUCTIONS

Jacking

The recommended jacking points are given in **LIFTING AND TOWING**, always ensure that any lifting apparatus has adequate load and safety capacity for the weight to be lifted. Ensure the vehicle is standing on level ground prior to lifting or jacking. Apply the handbrake and chock the wheels.

Never rely on a jack as the sole means of support when working beneath the vehicle. Use additional safety supports beneath the vehicle.

Do not leave tools, lifting equipment, spilt oil, etc. around or on the work bench area.

Precautions against damage

Always fit wing and seat covers before commencing work. Avoid spilling brake fluid or battery acid on paintwork. Wash off with water immediately if this occurs.

GENERAL INFORMATION

Disconnect the battery earth lead before starting work, see **ELECTRICAL PRECAUTIONS**.

Always use the recommended service tool or a satisfactory equivalent where specified.

Protect exposed bearing and sealing surfaces and screw threads from damage.

Brake shoes and pads

WARNING: Always fit the correct grade and specification of brake linings and renew brake pads and brake shoes in axle sets only.

Brake hydraulics

WARNING: It is imperative that the correct brake fittings are used and that threads of components are compatible.

Always use two spanners when slackening or tightening brake pipe or hose connections. Ensure that hoses run in a natural curve and are not kinked or twisted. Fit brake pipes securely in their retaining clips and ensure that the pipe run cannot contact a potential chafing point.

Containers used for hydraulic fluid must be kept absolutely clean. Do not store hydraulic fluid in an unsealed container, it will absorb water and in this condition would be dangerous to use. Do not allow hydraulic fluid to be contaminated with mineral oil, or use a container which has previously contained mineral oil. Do not re-use fluid from the system. Always use clean brake fluid or a recommended alternative to clean hydraulic components. Fit a blanking cap to an hydraulic union and a plug to its socket after removal to prevent the ingress of dirt. Absolute cleanliness must be observed with hydraulic components.

Engine coolant caps and plugs

Extreme care is necessary when removing engine coolant caps and plugs when the engine is hot and especially if it is overheated. To avoid the possibility of scalding allow the engine to cool before attempting coolant cap or plug removal.

Cleaning components

Always use the recommended cleaning agent or equivalent.

Do not use degreasing equipment for components containing items which could be damaged by the use of this process. Whenever possible clean components and the area surrounding them before removal. Always observe scrupulous cleanliness when cleaning dismantled components.

Joints and joint faces

Fit joints dry unless otherwise specified in this Manual.

If gaskets and/or jointing compound is recommended for use; remove all traces of old jointing material prior to reassembly. Do not use a tool which will damage the joint faces and smooth out any scratches or burrs on the joint faces using an oil stone. Do not allow dirt or jointing material to enter any tapped holes.

Prior to reassembly, blow through any pipes, channels or crevices with compressed air.

Screw threads

Both U.N.F and Metric threads to ISO standards are used.

Damaged nuts, bolts and screws must always be discarded.

Cleaning up damaged threads with a die or tap impairs the strength and closeness of fit of the threads and is not recommended.

Castellated nuts must not be slackened back to accept a split-pin, except in those recommended cases when this forms part of an adjustment.

Do not allow oil or grease to enter blind threaded holes. The hydraulic action on screwing in the bolt or stud could split the housing.

Always tighten a nut or bolt to the recommended torque figure. Damaged or corroded threads can affect the torque reading.

To check or re-tighten a bolt or screw to a specified torque figure, first slacken a quarter of a turn, then retighten to the correct torque figure.

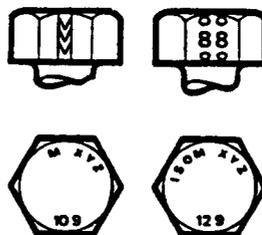

49C 362

Bolt identification

An ISO metric bolt or screw made of steel and larger than 6 mm in diameter can be identified by either of the symbols ISO M or M embossed or indented on top of the head.

In addition to marks to identify the manufacturer, the head is also marked with symbols to indicate the strength grade, e.g. 8.8; 10.9; 12.9; 14.9. As an alternative, some bolts and screws have the M and strength grade symbol on the flats of the hexagon.

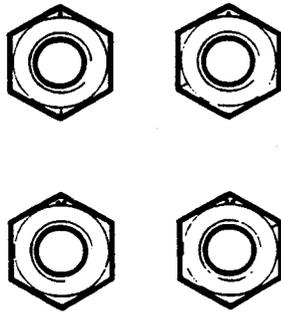

4NC 300



4NC 300

Nut identification

A nut with an ISO metric thread is marked on one face or on one of the flats of the hexagon with the strength grade symbol 8, 12, or 14. Some nuts with a strength grade 4, 5 or 6 are also marked and some have the metric symbol M on the flat opposite the strength grade marking.

A clock face system is used as an alternative method of indicating the strength grade. The external chambers or a face of the nut is marked in a position relative to the appropriate hour mark on a clock face to indicate the strength grade.

A dot is used to locate the 12 o'clock position and a dash to indicate the strength grade. If the grade is above 12, two dots identify the 12 o'clock position.

Locking devices

Always release locking tabs and fit new locking washers, do not re-use locking tabs. Always use a backing spanner when slackening or tightening brake and fuel pipe unions.

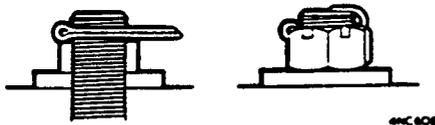

4NC 608

Fitting a split pin

Always fit new split-pins of the correct size for the hole in the bolt or stud. Do not slacken back nut to enter split-pin.

Always fit new roll pins of an interference fit in the hole.

Always fit new circlips of the correct size for the groove.

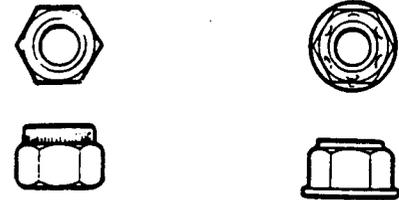

10M 0093

Self-locking nuts

Self-locking nuts, i.e. nylon insert or metal stiff nuts can be re-used providing resistance can be felt when the locking portion of the nut passes over the thread of the bolt or stud.

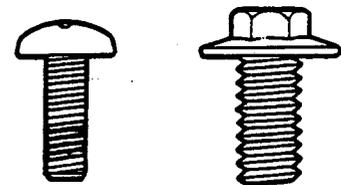

10M 0091

Self-locking bolts and screws

Self-locking bolts and screws, i.e. nylon patched or trilobular thread can be re-used providing resistance can be felt when the locking portion enters the female thread.

Nylon patched bolts and screws have a locking agent pre-applied to the threads. They are identified by the presence of a coloured section of thread which extends for up to 180° around the thread.

Trilobular i.e. Powerlok bolts have a special thread form which creates a slight interference in the tapped hole or threads of the nut into which it is screwed.

DO NOT re-use self-locking fasteners in critical locations e.g. engine bearings. Always use the correct replacement self-locking nut, bolt or screw.

DO NOT fit non self-locking fasteners in applications where a self-locking nut, bolt or screw is specified.



RM2652

Encapsulated bolts and screws

Encapsulated bolts and screws have a micro-encapsulated locking agent pre-applied to the thread. They are identified by the presence of a coloured section of thread which extends completely around the thread - 360°. The locking agent is released and activated by the assembly process and is then chemically cured to provide the locking action.

Unless a specific repair procedure states otherwise, encapsulated bolts may be re-used providing the threads are undamaged and the following procedure is adopted.

Remove loose adhesive from the bolt and housing threads, ensure threads are clean and free of oil and grease. Apply an approved adhesive.

Fit a new encapsulated bolt, or if not available a bolt of equivalent specification treated with an approved adhesive.

Oil seals

Always renew oil seals which have been removed from their working location either as an individual component or as part of an assembly.

Ensure the surface on which the new seal is to run is free of burrs or scratches. Renew the component if the original sealing surface cannot be completely restored.

Protect the seal from any surface which could cause damage over which it has to pass when being fitted. Use a protective sleeve or tape to cover the relevant surface.

Lubricate the sealing lips with a recommended lubricant before use to prevent damage in initial use. On dual lipped seals, smear the area between the lips with grease.

Use the recommended service tool to fit an oil seal.

If the correct service tool is not available, use a suitable tube approximately 0.4 mm smaller than the outside diameter of the seal.

Press or drift the seal in to the depth of its housing, with the sealing lip facing the lubricant to be retained if the housing is shouldered, or flush with the face of the housing where no shoulder is provided.

Service tools and garage equipment

Special service tools have been developed to facilitate removal, dismantling and assembly of mechanical components in a cost effective and practical manner without causing damage. Some operations in this Repair Manual cannot be carried out without the aid of the relevant service tools.

A range of 'MICROCHECK' programme cards have been developed to provide a means of fast effective diagnosis of faults on electronic systems currently fitted to ROVER vehicles.

It is essential that operators familiarise themselves with the components of the system to be checked and the instructions for the relevant 'MICROCHECK' programme card before commencing diagnosis.

Where specific garage equipment is required for diagnosis and repair, reference will be made in this manual to the Service Tools and Equipment Programme where details of the equipment recommended by Rover Service may be found.

Body repairs

Any damage found, that would affect the corrosion resistance of the vehicle during the Warranty period must be rectified by an authorised Rover Dealer to the standards, and by the methods, detailed in the Body Repair Manual.

Replacement body panels

Body panels are supplied coated in cathodic electrocoat primer.

Synthetic rubber

Many 'O' rings, seals, hoses, flexible pipes and other similar items which appear to be natural rubber, are in fact, made of synthetic materials called Fluoroelastomers. Under normal operating conditions this material is safe and does not present a health hazard. However, if the material is damaged by fire or excessive heating, it can break down and produce highly corrosive Hydrofluoric acid which can cause serious burns on contact with skin. If skin contact does occur:

- Remove any contaminated clothing immediately.
- Irrigate affected area with a copious amount of cold water or limewater for 15 to 60 minutes.
- Obtain medical assistance immediately

Should the material be in a burnt or over-heated condition handle only with seamless industrial gloves. Decontaminate and dispose of gloves immediately after use.



FUEL HANDLING PRECAUTIONS

General

The following information provides basic precautions which must be observed if petrol (gasoline) is to be handled safely. It also outlines other areas of risk which must not be ignored. This information is issued for basic guidance only, and if in doubt appropriate enquiries should be made of your local Fire Officer.

Petrol - Gasoline

Petrol/gasoline vapour is highly flammable and in confined spaces is also explosive and toxic.

When petrol/gasoline evaporates it produces 150 times its own volume in vapour which when diluted with air becomes a readily ignitable mixture. The vapour is heavier than air and will always fall to the lowest level. It can readily be distributed throughout a workshop by air currents; consequently, even a small spillage of petrol/gasoline is potentially very dangerous.

Always have a fire extinguisher containing FOAM, CO₂, GAS or POWDER close at hand when handling or draining fuel or when dismantling fuel systems and in other areas where fuel containers are stored.

Always disconnect the vehicle battery before carrying out dismantling or draining work on a fuel system.

Whenever petrol/gasoline is being handled, drained or stored or when fuel systems are being dismantled, all forms of ignition must be extinguished or removed; any leadlamps must be flameproof and kept clear of spillage.

WARNING: No one should be permitted to repair components associated with petrol/gasoline without first having specialist training.

Fuel tank draining

WARNING: Petrol/gasoline must not be extracted or drained from any vehicle whilst it is standing over a pit.

Draining or extraction of petrol/gasoline from a vehicle fuel tank must be carried out in a well ventilated area.

The receptacle used to contain the petrol/gasoline must be more than adequate for the full amount of fuel to be extracted or drained. The receptacle should be clearly marked with its contents, and placed in a safe storage area which meets the requirements of local authority regulations.

CAUTION: When petrol/gasoline has been extracted or drained from a fuel tank the precautions governing naked lights and ignition sources should be maintained.

Fuel tank removal

When the fuel line is secured to the fuel tank outlet by a spring steel clip, the clip must be released before the fuel line is disconnected or the fuel tank is removed. This procedure will avoid the possibility of residual petrol fumes in the fuel tank being ignited when the clip is released.

As an added precaution fuel tanks should have a 'PETROL (GASOLINE) VAPOUR' warning label attached to them as soon as they are removed from the vehicle.

Fuel tank repairs

Under no circumstances should a repair to any fuel tank involving heat treatment be carried out without first rendering the tank SAFE, by using one of the following methods:

- a. STEAMING: With the filler cap and tank unit removed, empty the tank. Steam the tank for at least two hours with low pressure steam. Position the tank so that condensation can drain away freely, ensuring that any sediment and sludge not volatilized by the steam is washed out during the steaming process.
- b. BOILING: With the filler cap and tank unit removed, empty the tank. Immerse the tank completely in boiling water containing an effective alkaline degreasing agent or a detergent, with the water filling and also surrounding the tank for at least two hours.

After steaming or boiling, a signed and dated label to this effect should be attached to the tank.

Body and chassis repairs

When a body or chassis repairs involve the use of heat, all fuel pipes which run in the vicinity of the repair area must be removed, and the tank outlet plugged, BEFORE HEAT IS APPLIED. If the repair is in the vicinity of the fuel tank, the tank must be removed.

Plastic fuel pipes are particularly susceptible to heat, even at relatively low temperature, and can be melted by heat conducted from some distance away.

Fuel lines or tanks must not be removed whilst the vehicle is over an inspection pit.

GENERAL INFORMATION

ELECTRICAL PRECAUTIONS

General

The following guidelines are intended to ensure the safety of the operator whilst preventing damage to the electrical and electronic components fitted to the vehicle. Where necessary specific precautions are detailed in the relevant sections of this manual which should be referred to prior to commencing repair operations.

Equipment – Prior to commencing any test procedure on the vehicle ensure that the relevant test equipment is working correctly and any harness or connectors are in good condition, this particularly applies to mains lead and plugs.

WARNING: Before commencing work on an ignition system all high tension terminals, adapters and diagnostic equipment for testing should be inspected to ensure that they are adequately insulated and shielded to prevent accidental personal contacts and minimise the risk of shock. Wearers of surgically implanted pacemaker devices should not be in close proximity to ignition circuits or diagnostic equipment.

Polarity – Never reverse connect the vehicle battery and always observe the correct polarity when connecting test equipment.

High Voltage Circuits – Whenever disconnecting live h.t. circuits always use insulated pliers and never allow the open end of the h.t. lead to come into contact with other components particularly E.C.U's. Exercise caution when measuring the voltage on the coil terminals while the engine is running, high voltage spikes can occur on these terminals.

Connectors and Harness – The engine compartment of a vehicle is a particularly hostile environment for electrical components and connectors. Always ensure these items are dry and oil free before disconnecting and connecting test equipment. Never force connectors apart either by using tools or by pulling on the wiring harness. Always ensure locking tabs are disengaged before removal and not orientation to enable correct reconnection. Ensure that any protective covers and substances are replaced if disturbed.

Having confirmed a component to be faulty switch off the ignition and disconnect the battery. Remove the component and support the disconnected harness. When replacing the component keep oily hands away from electrical connection areas and push connectors home until any locking tabs fully engage.

Battery disconnecting

Before disconnecting the battery, switch off all electrical equipment. If the radio is to be serviced, ensure the security code has been deactivated.

CAUTION: To prevent damage to electrical components ALWAYS disconnect the battery when working on the vehicle electrical system. The earth lead must be disconnected first and reconnected last.

Always ensure that battery leads are routed correctly and are not close to any potential chafing points.

Battery charging

Recharge the battery out of the vehicle and keep the top well ventilated. While being charged or discharged, and for approximately fifteen minutes afterwards, batteries emit hydrogen gas. This gas is inflammable.

Always ensure any battery charging area is well ventilated and that every precautions is taken to avoid naked flames and sparks.

Disciplines

Switch off ignition prior to making any connection or disconnection in the system as electrical surge caused by disconnecting 'live' connections can damage electronic components.

Ensure hands and work surfaces are clean and free of grease, swarf, etc. as grease collects dirt which can cause tracking or high – resistance contacts.

When handling printed circuit boards, treat them as you would a hi – fi record – hold by the edges only; note that some electronic components are susceptible to body static.

Connectors should never be subjected to forced removal or refit, especially inter – board connectors, damaged contacts will cause short – circuit and open – circuit conditions.

Prior to commencing test, and periodically during test, touch a good earth, i.e. cigar lighter socket, to discharge body static as some electronic components are vulnerable to static electricity.

Grease for electrical connectors

All under bonnet and under body connectors are protected against corrosion by the application of a special grease on production. Should connectors be disturbed in service or repaired or replaced, a grease of this type, available in 150 gm tubes under Part No. BAU 5811, should again be applied.

Note: The use of other greases must be avoided as they can migrate into relays, switches etc. contaminating the contacts and leading to intermittent operation or failure.

INFORMATION



CONTENTS

General Data	Page
Engine	1
Fuel system - Carburetter	1
Fuel system - SPi	1
Cooling system	1
Clutch	2
Manual gearbox	2
Automatic gearbox	2
Drive shafts	2
Final drive	2
Steering	3
Suspension	3
Brakes	4
Wheels	4
Tyres	4
Electrical	5
Dimensions	5
Weights	5

Engine Tuning Data	Page
1.3 Mini with Carburetter - Manual gearbox models	1
1.3 Mini with Carburetter - Automatic gearbox models	2
1.3 Mini with SPi - Manual gearbox models	3
1.3 Mini with SPi - Automatic gearbox models	4
1.3 Mini with SPi - High compression engine	5

Torque Wrench Settings	Page
General	1
Maintenance	1
Engine	1
Carburetter & ignition	1
Modular engine management system - SPi	2
Fuel system	2
Cooling	2
Manifold and exhausts	2
Clutch	2
Manual gearbox	3
Automatic gearbox	3
Differential	3
Steering	3
Suspension	4
Brakes	4
Body	4
Electrical	4

Capacities, Fluids and Lubricants	Page
Capacities	1
Fluids	1
Lubrication	2



ENGINE

Engine number prefix	12A
Type	8 valve
Cylinder arrangement	4 in line - transverse
Bore	70.61 mm
Stroke	81.28 mm
Capacity	1275 cm ³
Firing order	1-3-4-2
Rotation	Clockwise

Valve Timing

Inlet: Opens at	9° B.T.D.C.
Closes at	41° A.B.D.C.
Exhaust: Opens at	55° B.B.D.C.
Closes at	17° A.T.D.C.

Lubrication

System type	Wet sump, camshaft driven eccentric rotor pump
Relief valve opening pressure	4.2 kgf/cm ²
Pressure at idle	1.05 kgf/cm ²
Oil pressure warning light switch opens	0.4 to 0.7 kgf/cm ²
Oil filter	Full flow with renewable element cartridge

FUEL SYSTEM - CARBURETTER

Carburetter data	See Engine Tuning Data
Fuel Pump	
Type	Mechanical camshaft driven

FUEL SYSTEM - SPi

Electronic fuel injection data	See Engine Tuning Data
Fuel Pump	
Type	Electric immersible
Pump maximum pressure at 16V	2.7 bar
Regulated injection pressure	1.0 to 1.1 bar

COOLING SYSTEM

Pressure cap opens	1.05 kgf/cm ²
Thermostat open	88°C
Starts to open	85°C
Auxiliary cooling fan switch on temperature	98°C
Switch off temperature	93°C

INFORMATION

CLUTCH

Make and type	Verto/Valeo, diaphragm spring. Hydraulically operated.	
Clutch plate diameter	181 mm	7 ¹ / ₈ in
Master cylinder bore	15.88 mm	0.625 in
Slave cylinder bore	22.22 mm	0.875 in

MANUAL GEARBOX

Gear ratios:	
Fourth	1.000:1
Third	1.425:1
Second	2.185:1
First	3.647:1
Reverse	3.667:1

AUTOMATIC GEARBOX

Type	Automotive Products, torque converter
------------	---------------------------------------

Gear ratios:	
Drive	1.0:1
Third	1.46:1
Second	1.845:1
First	2.69:1
Reverse	2.69:1

DRIVE SHAFTS

Make and type	Hardy Spicer, solid shaft, with outboard constant velocity joints.
---------------------	--

FINAL DRIVE

Gearbox code ECM 19/59 (Blue)

Ratio	3.105:1
-------------	---------

Road speed at 1000 rev/min

Fourth	28.6 kph	17.8 mph.
Third	20.1 kph	12.5 mph
Second	13.1 kph	8.2 mph
First	7.9 kph	4.9 mph

Speedometer gear ratio	7:17
------------------------------	------



Gearbox code HPD 19/61 (Green)

Ratio 3.21:1

Road speed at 1000 rev/min

Fourth	29 kph	18.0 mph
Third	20.3 kph	12.6 mph
Second	13.3 kph	8.2 mph
First	7.9 kph	4.9 mph

Speedometer gear ratio 7:17

Automatic gearbox

Ratio 2.69:1

Road speed at 1000 rev/min

Drive	29.3 kph	18.2 mph
Third	20.1 kph	12.5 mph
Second	15.9 kph	9.9 mph
First	10.9 kph	6.8 mph

Speedometer gear ratio 7:17

STEERING

Type	Rack and pinion	
Front wheel alignment	1/16 in Toe - out	1.6 mm
Front wheel camber	2° ± 1° Positive	
Front wheel castor	3° ± 1° Positive	
Steering angle of wheels at full lock	Inner wheel 34.5°	Outer wheel 30°
Steering wheel turns - lock to lock	2.7	

Rear suspension geometry

Rear wheel camber	1/8 in Toe - in	3.18 mm
Rear wheel camber	1° positive + 1.5° - 0.5°	

Note: Steering and suspension geometry settings are for a vehicle at kerbside weight.

SUSPENSION

Front

Type Independent rubber cone spring with telescopic hydraulic dampers.

Rear

Type Independent trailing arm with rubber cone spring and telescopic hydraulic dampers.

Radius arm bushes (reamed bore) 0.8145 to 0.8150 in 20.69 to 20.70 mm



ELECTRICAL

System 12 Volt, Negative earth return with voltage control.

Battery

Type - Maintenance free 138
 Cold crank 265 amps
 Reserve capacity 45 minutes

Alternator

Type A127 - 45
 Maximum output 45 amps
 Regulator 21TR

Starter motor

Type M79
 Power 0.8 kW

DIMENSIONS

Overall length
 Saloon 3.05 m 10 ft 0¹/₄ in
 Cabriolet 3.09 m 10 ft 2 in
 Overall width (including mirrors) 1.58 m 5 ft 2¹/₂ in
 Overall height
 Saloon 1.34 4 ft 4³/₄ in
 Cabriolet 1.364 m 4 ft 5³/₄ in
 Ground clearance
 Saloon 163 mm 6¹/₂ in
 Cabriolet 102 mm 4 in
 Wheelbase 2.04 m 6 ft 8¹/₄ in
 Turning circle (kerb to kerb) 8.6 m 28 ft 6 in

WEIGHTS

Unladen weight (full fuel tank without options)

1.3 Carburettor models
 Manual 685 kg 1510 lb
 Automatic 710 kg 1565 lb
 1.3 SPi models
 Manual 685 kg 1510 lb
 Automatic 710 kg 1565 lb
 1.3i Cooper 695 kg 1532 lb
 Cabriolet 760 kg 1676 lb
 Max gross vehicle weight
 Saloon 1050 kg 2315 kg
 Cabriolet 1070 kg 2359 lb
 Maximum roof rack weight (distributed) 40 kg 90 lb
 Maximum towing weight with braked trailer -
 restart 12%, 1 in 8 gradient with two occupants
 in vehicle 405 kg 895 lb
 Towing hitch downward load 50 kg 110 lb



Model: 1.3 Mini with Carburetter Manual Gearbox models

Engine

Type/capacity	2A2BG03/1275 cm ³
Firing order	1-3-4-2
Compression ratio	9.4:1
Idle speed	850 ± 50 rev/min
Fast idle speed (Set at first detent of choke control)	1300 rev/min
Exhaust gas CO content at idle	0.3 - 1.5%
Ignition timing at 1500 rev/min:*	
Vacuum disconnected	5° ± 1° B.T.D.C.
Valve/rocker clearance (cold)	0.27 to 0.33 mm

Ignition System

Distributor	Lucas 65DM4 Electronic
Serial No.	42535A
Ignition amplifier	Lucas 9EM
Serial No.	84896A
Vacuum unit identification	75-305-12
Deceleration check: *	
Vacuum disconnected	15° to 17° BTDC at 6250 rev/min
	13° to 15° BTDC at 5340 rev/min
	7° to 9.5° BTDC at 2840 rev/min
	4° to 6° BTDC at 1870 rev/min
	-1° to +1° BTDC at 1000 rev/min
Vacuum advance	
Starts	75 mmHg
Ends*	24° at 305 mmHg

Ignition coil

Type	AUU 1326 or ADU 8779
Primary resistance at 20°C	0.71 to 0.81 ohm
Consumption - engine idling	0.25 to 0.75 amp average

Spark plugs

Type	GSP 4462
Gap	0.85 ± 0.05 mm

Carburetter

Type	HIF 38
Part No	MAC 10031
Needle identification	AEM
Needle valve seat	LZX 1541
Jet size	0.090 in
Piston damper	LZX 1511
Piston spring colour	RED
Fuel grade	95 RON minimum - UNLEADED fuel

CAUTION: Serious damage to the engine may occur if a lower octane number fuel than recommended is used. Serious damage to the engine will occur if leaded fuel is used.

* Crankshaft degrees and rev/min

INFORMATION

Model: 1.3 Mini with Carburetter Automatic Gearbox models

Engine

Type/capacity	2A2BG05/1275 cm ³
Firing order	1-3-4-2
Compression ratio	9.4:1
Idle speed	850 ± 50 rev/min
Fast idle speed (Set at first detent of choke control)	1400 rev/min
Exhaust gas CO content at idle	0.3 - 1.5%
Ignition timing at 1500 rev/min:*	
Vacuum disconnected	5° ± 1° B.T.D.C.
Valve/rocker clearance (cold)	0.27 to 0.33 mm

Ignition System

Distributor	Lucas 65DM4 Electronic
Serial No.	42535A
Ignition amplifier	Lucas 9EM
Serial No.	84896A
Vacuum unit identification	75-305-12
Deceleration check: *	
Vacuum disconnected	15° to 17° BTDC at 6250 rev/min 13° to 15° BTDC at 5340 rev/min 7° to 9.5° BTDC at 2840 rev/min 4° to 6° BTDC at 1870 rev/min -1° to +1° BTDC at 1000 rev/min

Vacuum advance

Starts	75 mmHg
Ends*	24° at 305 mmHg

Ignition coil

Type	AUU 1326 or ADU 8779
Primary resistance at 20°C	0.71 to 0.81 ohm
Consumption - engine idling	0.25 to 0.75 amp average

Spark plugs

Type	GSP 4462
Gap	0.85 ± 0.05 mm

Carburetter

Type	HIF 38
Part No	MAC 10032
Needle identification	AEM
Needle valve seat	LZX 1541
Jet size	0.090 in
Piston damper	LZX 1511
Piston spring colour	RED
Fuel grade	95 RON minimum - UNLEADED fuel

CAUTION: Serious damage to the engine may occur if a lower octane number fuel than recommended is used. Serious damage to the engine will occur if leaded fuel is used.

* Crankshaft degrees and rev/min



Model: 1.3 Mini with SPI
Manual Gearbox models

Engine

Type/capacity	12A2DF75/1275 cm ³
Firing order	1 - 3 - 4 - 2
Compression ratio	9.4:1
Idle speed controlled by E.C.U.	850 ± 25 rev/min
Exhaust gas CO content at idle	0.5% max. Not adjustable
Ignition timing at idle speed:* Vacuum connected	15° B.T.D.C. + 10° to - 11° for idle speed control
Valve/rocker clearance (cold)	0.27 to 0.33 mm

Programmed ignition

Distributor	NJC 10034
Distributor rotor arm	Resistive type
Rotation	Anti - clockwise
Crankshaft sensor	ADU 7340

Ignition coil

Type	AUU 1326 or ADU 8779
Primary resistance at 20°C	0.71 to 0.81 ohm
Consumption - engine idling	0.25 to 0.75 amp average

Spark plugs

Type	GSP 4462
Gap	0.85 ± 0.05 mm

Electronic fuel injection

Type	Indirect single - point injection with E.C.U. control using speed/density method of air flow measurement
M.E.M.S. - E.C.U.	MNE 101040
Injector and pressure regulator unit	JZX 3300
Fuel pressure	1.0 bar ± 4.0% constant
Lost motion gap at idle speed	Equal either side of lever
Throttle potentiometer voltage: Throttle closed	0 to 1 V
Throttle open	4 to 5 V
Fuel grade	95 RON minimum - UNLEADED fuel

CAUTION: *Serious damage to the engine may occur if a lower octane number fuel than recommended is used. Serious damage to the engine will occur if leaded fuel is used.*

* Crankshaft degrees and rev/min

INFORMATION

Model: 1.3 Mini with SPi Automatic Gearbox models

Engine

Type/capacity	12A2DF76/1275 cm ³
Firing order	1-3-4-2
Compression ratio	10.1:1
Idle speed controlled by E.C.U.	850 ± 25 rev/min
Exhaust gas CO content at idle	0.5% max. Not adjustable
Ignition timing at idle speed:*	
Vacuum connected	15° B.T.D.C. +10° to -11° for idle speed control
Valve/rocker clearance (cold)	0.27 to 0.33 mm

Programmed ignition

Distributor	NJC 10034
Distributor rotor arm	Resistive type
Rotation	Anti-clockwise
Crankshaft sensor	ADU 7340

Ignition coil

Type	AUU 1326 or ADU 8779
Primary resistance at 20°C	0.71 to 0.81 ohm
Consumption - engine idling	0.25 to 0.75 amp average

Spark plugs

Type	GSP 4462
Gap	0.85 ± 0.05 mm

Electronic fuel injection

Type	Indirect single-point injection with E.C.U. control using speed/density method of air flow measurement
M.E.M.S. - E.C.U.	MNE 101060
Injector and pressure regulator unit	JZX 3300
Fuel pressure	1.0 bar ± 4.0% constant
Lost motion gap at idle speed	Equal either side of lever
Throttle potentiometer voltage:	
Throttle closed	0 to 1 V
Throttle open	4 to 5 V
Fuel grade	95 RON minimum - UNLEADED fuel

CAUTION: Serious damage to the engine may occur if a lower octane number fuel than recommended is used. Serious damage to the engine will occur if leaded fuel is used.

* Crankshaft degrees and rev/min



Model: 1.3 Mini with SPi
High compression engine

Engine

Type/capacity	12A2EF77/1274 cm ³
Firing order	1-3-4-2
Compression ratio	10.1:1
Idle speed controlled by E.C.U.	850 ± 25 rev/min
Exhaust gas CO content at idle	0.5% max. Not adjustable
Ignition timing at idle speed:*	
Vacuum connected	15° B.T.D.C. + 10° to - 11° for idle speed control
Valve/rocker clearance (cold)	0.27 to 0.33 mm

Programmed ignition

Distributor	NJC 10034
Distributor rotor arm	Resistive type
Rotation	Anti - clockwise
Crankshaft sensor	ADU 7340

Ignition coil

Type	AUU 1326 or ADU 8779
Primary resistance at 20°C	0.71 to 0.81 ohm
Consumption - engine idling	0.25 to 0.75 amp average

Spark plugs

Type	GSP 4462
Gap	0.85 ± 0.05 mm

Electronic fuel injection

Type	Indirect single - point injection with E.C.U. control using speed/density method of air flow measurement
M.E.M.S. - E.C.U.	MNE 101070
Injector and pressure regulator unit	JZX 3300
Fuel pressure	1.0 bar ± 4.0% constant
Lost motion gap at idle speed	Equal either side of lever
Throttle potentiometer voltage:	
Throttle closed	0 to 1 V
Throttle open	4 to 5 V
Fuel grade	95 RON minimum - UNLEADED fuel

CAUTION: *Serious damage to the engine may occur if a lower octane number fuel than recommended is used. Serious damage to the engine will occur if leaded fuel is used.*

* Crankshaft degrees and rev/min



GENERAL

– for bolts and nuts not otherwise specified

M5	4 Nm
M6	6 Nm
M8	18 Nm
M10	35 Nm
M12	65 Nm
M14	80 Nm
M16	130 Nm
1/4 UNC/UNF	8 Nm/10 Nm
5/16 UNC and UNF	25 Nm
3/8 UNC and UNF	40 Nm
7/16 UNC and UNF	75 Nm
1/2 UNC and UNF	90 Nm
5/8 UNC and UNF	135 Nm

MAINTENANCE

Refer to appropriate Sections

ENGINE

Oil sump drain plug	34 Nm
Engine mounting to subframe – nuts	22 Nm
Rear engine mounting to bracket – nuts	22 Nm
Gear selector steady rod to gearbox – bolt	18 Nm
Engine steady bar mounting bracket to body – bolts	22 Nm
Engine steady bar through bolts	22 Nm
Engine breather to flywheel housing – bolts	18 Nm
Cylinder head nuts:*	
Stage 1	34 Nm
Stage 2	68 Nm
Rocker shaft bracket to cylinder head – nuts	32 Nm
Rocker cover nuts	5 Nm
Main bearing caps to cylinder block – bolts	85 Nm
Big end bearing cap bolts	45 Nm
Camshaft locating plate screws	11 Nm
Oil pump to cylinder block – nuts	11 Nm
Flywheel housing to cylinder block – bolts	25 Nm
Crankshaft pulley bolt	102 Nm
Timing gear nuts	88 Nm
Timing chain tensioner bolts	22 Nm
Timing gear cover bolts	16 Nm

* Tighten in sequence.

CARBURETTER & IGNITION

Distributor cap screws	2 Nm
Distributor clamp bolt	20 Nm
Spark plug	25 Nm
Amplifier module to distributor – bolts	5 Nm
Carburetter to manifold – nuts	22 Nm
Thermal vacuum switch to thermostat housing	10 Nm

INFORMATION

MODULAR ENGINE MANAGEMENT SYSTEM - SPI

Throttle body to manifold - nuts	10 Nm
Distributor cap screws	2 Nm
Spark plugs	25 Nm
Crankshaft sensor to flywheel housing - screws	6 Nm
Air temperature sensor to air cleaner	7 Nm
Oxygen sensor to front pipe	55 Nm
Injector housing to throttle body - screws	5 Nm
Injector housing fuel pipe unions	24 Nm
Fuel pipe bracket to throttle body - nuts	10 Nm

FUEL SYSTEM

Fuel pump to fuel tank - nuts	9 Nm
Fuel pump to cylinder block - bolts	11 Nm
Two way breather valve to fuel tank - nut	9 Nm

COOLING

Thermostat housing to cylinder head - nuts	11 Nm
Radiator top mounting bracket bolts	18 Nm
Radiator lower mounting bracket to gearbox - bolts	22 Nm
Radiator lower mounting bracket to engine mounting bolt	22 Nm
Cooling fan to coolant pump pulley - bolts	11 Nm
Radiator cowl bolts	5 Nm
Coolant pump to cylinder block - bolts	22 Nm

MANIFOLD AND EXHAUSTS

Exhaust manifold to cylinder head - bolts :	
Carburettor models	19 Nm
SPi models	22 Nm
Exhaust front pipe to manifold - nuts	22 Nm
Exhaust front pipe to gearbox bracket - bolt	22 Nm
Exhaust sample pipe to front pipe	22 Nm
Catalytic converter to front pipe - nuts	45 Nm
Catalytic converter to tailpipe - nuts	9 Nm

CLUTCH

Clutch pressure plate to flywheel - bolts	25 Nm
Flywheel to crankshaft bolt	152 Nm



MANUAL GEARBOX

Gearbox casing to cylinder block – bolts	8 Nm
Flywheel housing to cylinder block – bolts :	
3/8 UNF	35 Nm
5/16 UNF	25 Nm
Third motion shaft bearing retainer screws	18 Nm
Final drive gear pinion nut	200 Nm
First motion shaft gear nut	200 Nm
Speedometer drive housing to gearbox casing screws	25 Nm

AUTOMATIC GEARBOX

Oil filter bowl retaining bolt	19 Nm
Selector lever cable clamp screws	4 Nm
Inhibitor switch locknut	5 Nm
Gear train assembly to gearbox casing – dowel bolt	38 Nm
Selector cable housing to selector lever housing – bolts	4 Nm
Converter housing to cylinder block – nuts and bolts	25 Nm
Converter input shaft nut	95 Nm
Converter centre bolts	30 Nm
Converter to crankshaft – bolt	150 Nm
Top/reverse clutch hub nut	200 Nm
Servo unit to gearbox casing – bolts	23 Nm
Valve block to gearbox casing – bolts	14 Nm
Governor housing screws	18 Nm
Kickdown control assembly to gearbox casing – screws	7 Nm
First gear free wheel housing to gear train – bolts	8 Nm
Valve block cover bolts:	
5/16 UNF	25 Nm
3/8 UNF	40 Nm

DIFFERENTIAL

Differential housing to gearbox – nuts	35 Nm
Final drive gear to differential cage – bolts	80 Nm
Final drive gear pinion – nut	200 Nm
Differential end cover bolts	25 Nm

STEERING

Steering wheel nut	47 Nm
Steering column upper mounting to fascia rail bolt	25 Nm
Inner column to steering rack pinion – pinch bolt	16 Nm
Track rod ball joint to steering arm nut	30 Nm
Steering rack 'U' bolts	15 Nm
Steering rack pinion cover bolts	15 Nm
Steering arm to front hub bolts	45 Nm

INFORMATION

SUSPENSION

Road wheel nuts	60 Nm
Suspension arm to swivel hub ball joint - nut	52 Nm
Tie rod arm lock nuts	52 Nm
Front damper to body nut	37 Nm
Front damper to suspension arm - through bolt	48 Nm
Upper arm pivot shaft nut	72 Nm
Lower arm pivot shaft nut	45 Nm
Ball joint retainer nut	102 Nm
Drive shaft hub nut (align to next split pin hole)	260 Nm
Rear hub nut (align to next split pin hole)	80 Nm
Radius arm pivot shaft nut	72 Nm
Sub-frame to body - bolts	25 Nm

BRAKES

Caliper bleed screw	9 Nm
Brake servo banjo bolt	50 Nm
Brake servo to mounting bracket - nuts	25 Nm
Brake servo mounting bracket to body - nuts and bolts	25 Nm
Brake caliper to swivel hub bolts	52 Nm
Brake disc to drive flange - bolts	57 Nm
Master cylinder to brake servo - nuts	25 Nm
Brake drum back plate to radius arm - bolts	28 Nm
Pressure reducing valve to body - bolt	17 Nm

BODY

Bonnet hinge nuts	10 Nm
Bonnet lock pin bolts	10 Nm
Luggage compartment lid hinge nuts	10 Nm
Door hinge to body bolts	24 Nm
Seat belt upper and lower anchorage bolts	32 Nm
Seat belt stalk to body - bolt	32 Nm
Seat belt reel to body - bolt	32 Nm
Fabric sun roof clamping strip nuts	4 Nm
Hood frame to body mounting bolts	25 Nm
Hood rear retaining rail to rear shelf - bolts	10 Nm

ELECTRICAL

Alternator mounting bolts	22 Nm
Alternator pivot link bolts	25 Nm
Alternator shaft pulley nut	37 Nm
Starter motor to flywheel housing	37 Nm
Starter solenoid terminal nuts	4 Nm
Auxiliary driving lamp bracket to body	15 Nm
Dim dip resistor to body - bolt	9 Nm
Coolant temperature sensor	22 Nm



CAPACITIES

Fuel tank	34 litres
Engine oil refill and filter change	
Manual gearbox	4.8 litres
Automatic gearbox	5.1 litres
Cooling system refill	3.55 litres
Washer reservoir	2.3 litres

FLUIDS

Brake Fluid

Use only AP New Premium Super DOT 4 brake fluid or Castrol Girling Universal DOT 4 brake/clutch fluid. DO NOT use any other type of fluid.

Anti - freeze solutions

The overall anti - freeze concentration should not fall, by volume, below 30% to ensure that the anti - corrosion properties of the coolant are maintained. Anti - freeze concentrations greater than 60% are not recommended as cooling efficiency will be impaired.

Use UNIPART Superplus Anti - freeze and Summer Coolant to protect the cooling system.

The cooling system should be drained, flushed and refilled with the correct amount of anti - freeze solution at three years and every two years thereafter.

CAUTION: No other 'universal' anti - freeze should be used with UNIPART Superplus anti - freeze and Summer Coolant.

If UNIPART Superplus Anti - freeze is not available, use an ethylene glycol based anti - freeze containing no methanol with non - phosphate corrosion inhibitors which meet specifications BS6580 and BS5117 suitable for use in mixed metal engines. To ensure the protection of the cooling system against corrosion these anti - freezes must be renewed every 12 months.

After filling with anti - freeze solution, attach a warning label to a prominent position on the vehicle stating the type of anti - freeze contained in the cooling system to ensure that the correct type is used for topping - up.

The recommended quantities of anti - freeze for different degrees of frost protection are:

Solution	Amount of anti - freeze		Commences freezing		Frozen solid	
	Litres	Pts	°C	°F	°C	°F
33 ¹ / ₃	1.2	2.1	- 19	- 2	- 36	- 33
50	1.8	3 ¹ / ₄	- 36	- 33	- 48	- 53

INFORMATION

LUBRICATION

The engine and other lubricating systems are filled with high - performance lubricants giving prolonged life.

CAUTION: You should always use a high quality oil of the correct viscosity range in the engine and gearbox during maintenance and when topping - up. The use of oil not to the correct specification can lead to high oil and fuel consumption and ultimately to damaged components.

Oil to the correct specification contains additives which disperse the corrosive acids formed by combustion and prevent the formation of sludge which can block the oil ways. Additional oil additives should not be used.

Always adhere to the recommended servicing intervals.

Engine, oil

Use oil meeting specification RES.22.OL.G4 or the requirements of CCMC G4, and having a viscosity band recommended for the temperature range of your locality. Where oils to these RES and European specifications are not available, well known brands of oils meeting API SF or SF/CD quality should be used.

SERVICE LUBRICANTS - ALL SEASONS

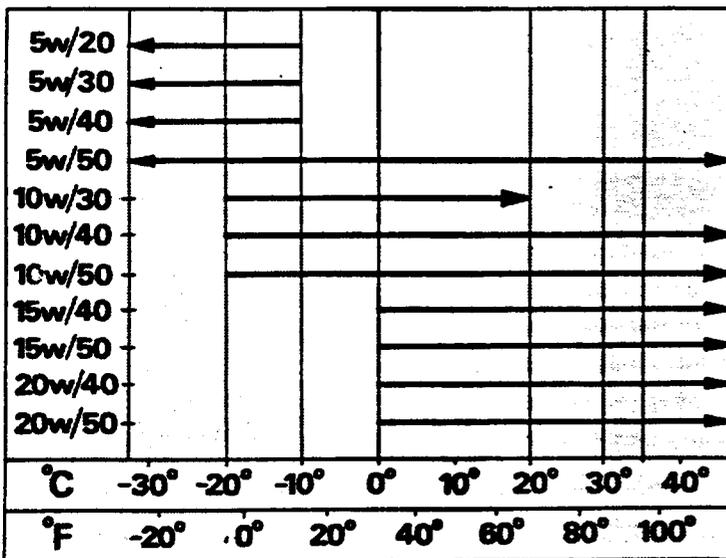

XH0088

Steering rack

Use Sterak grease specification 31.815.252 in accordance with specification 31.820.194; a total quantity of 100 cm³ is required to fill a rack from the dry condition.

General greasing

Use Multipurpose Lithium Base Grease N.L.G.I. consistency No. 2.

Fuel

Fuel recommendations are given on each page of 'ENGINE TUNING DATA'.

CAUTION: Serious damage to the engine may occur if fuel of the incorrect grade or type is used.

ENGINE OIL VISCOSITY/TEMPERATURE RANGES

MAINTENANCE

CONTENTS

Underbonnet locations - Carburetter	2
Underbonnet locations - SPi	3
Lubrication	4
Check engine and transmission	5
Engine oil and filter	5
Drive belt tension	6
Fuel system hoses, pipes and unions	7
Valve rocker adjustment	8
Air cleaner element - Carburetter	9
Air cleaner element - SPi	9
Carburetter piston damper	10
Spark plugs renew	10
Distributor cap, ht cables and coil tower	11
Ignition timing - carburetter	11
Engine tuning - SPi	11
Engine tuning - Carburetter models	12
Cooling system	13
Exhaust system	14
Drive shaft gaiters	14
Grease points	15
Steering	16
Road wheels and fastenings	17
Tyre pressures and condition	17
Footbrake	17
Brake servo air filter	17
Brakes	18
Front brake pads	18
Rear brake linings	19
Brake and clutch fluid level	20
Brake fluid	20
Handbrake cable adjust	21
Windscreen washer	22
Screen wipers and blades	22
Lamps, horns and warning indicators	23
Battery connections	23
Road test	24



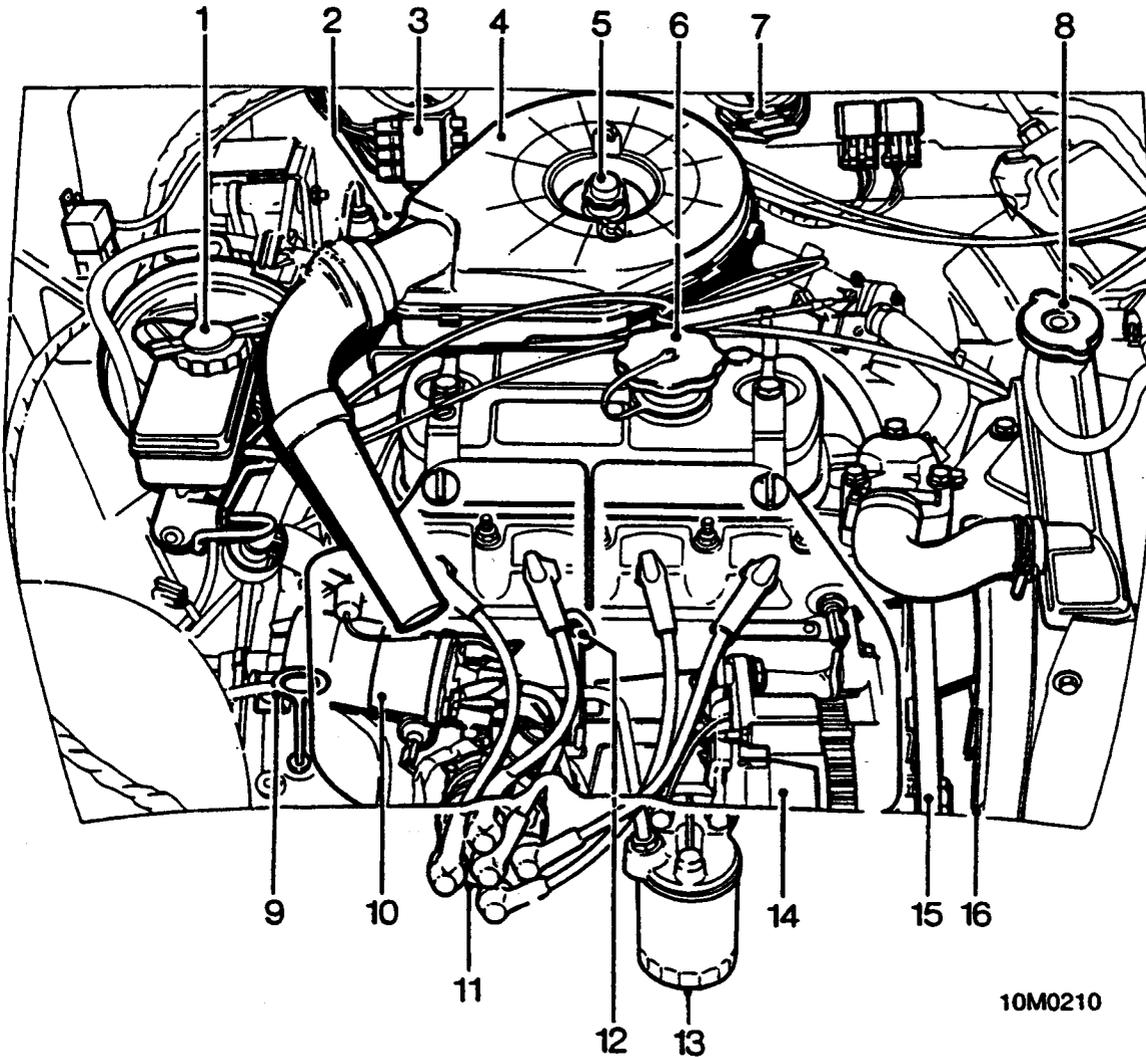

10M0210

UNDERBONNET LOCATIONS - CARBURETTER

- | | |
|--|----------------------------------|
| 1. Brake fluid reservoir | 10. Coil |
| 2. Clutch fluid reservoir | 11. Distributor |
| 3. Fusebox | 12. Engine oil dipstick (Manual) |
| 4. Air cleaner | 13. Engine oil filter |
| 5. Carburettor piston damper | 14. Alternator |
| 6. Engine oil filler cap and breather filter | 15. Drive belt |
| 7. Inline fuses | 16. Radiator cooling fan |
| 8. Radiator filler cap | |
| 9. Engine oil dipstick (Automatic) | |

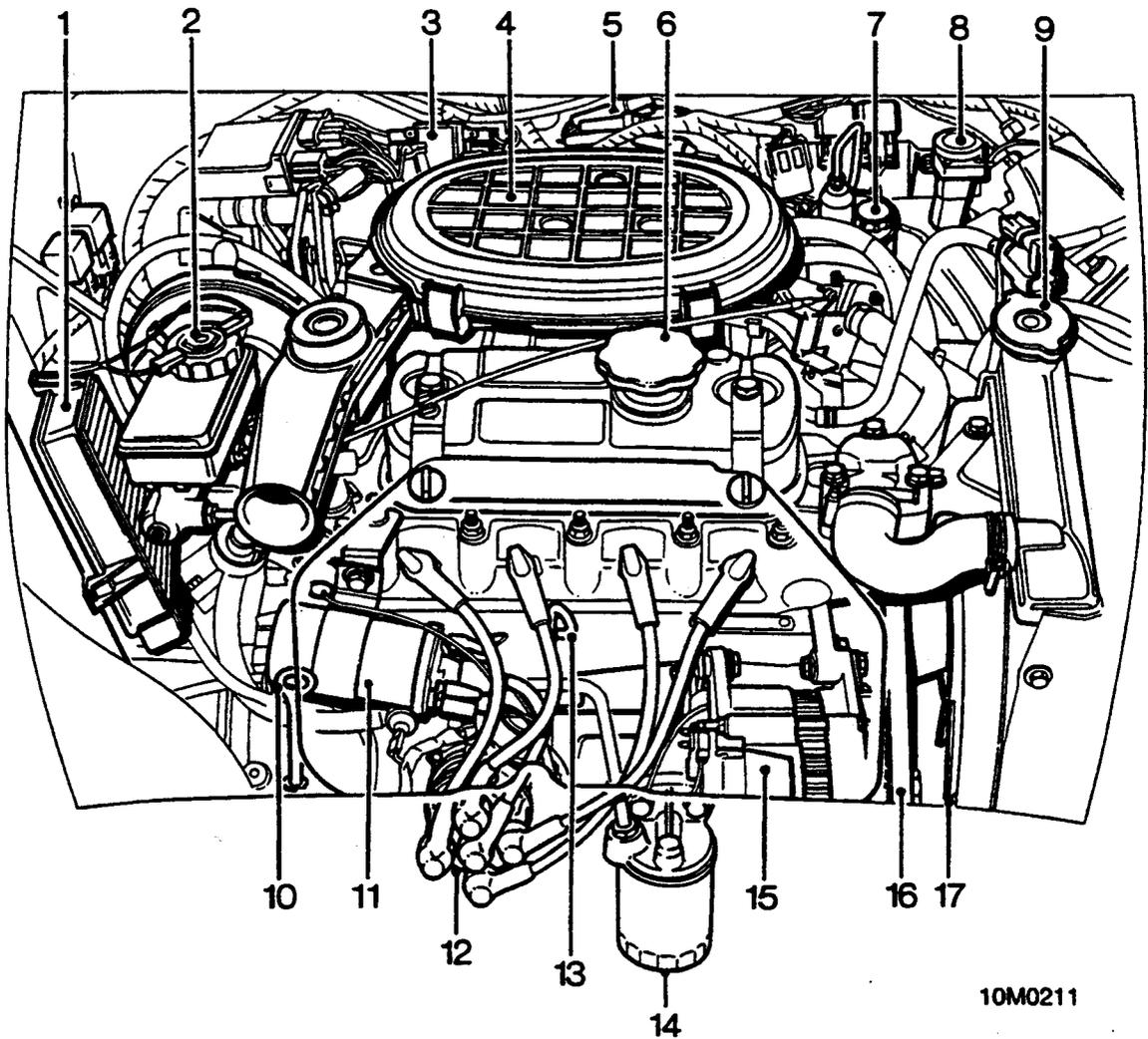

10M0211

UNDERBONNET LOCATIONS - SPi

- | | |
|--|-------------------------------------|
| 1. Engine management ECU | 10. Engine oil dipstick (Automatic) |
| 2. Brake fluid reservoir | 11. Coil |
| 3. Fusebox | 12. Distributor |
| 4. Air cleaner | 13. Engine oil dipstick (Manual) |
| 5. Inline fuses | 14. Engine oil filter |
| 6. Engine oil filler cap and breather filter | 15. Alternator |
| 7. Clutch fluid reservoir | 16. Drive belt |
| 8. Fuel cut - off switch | 17. Radiator cooling fan |
| 9. Radiator filler cap | |

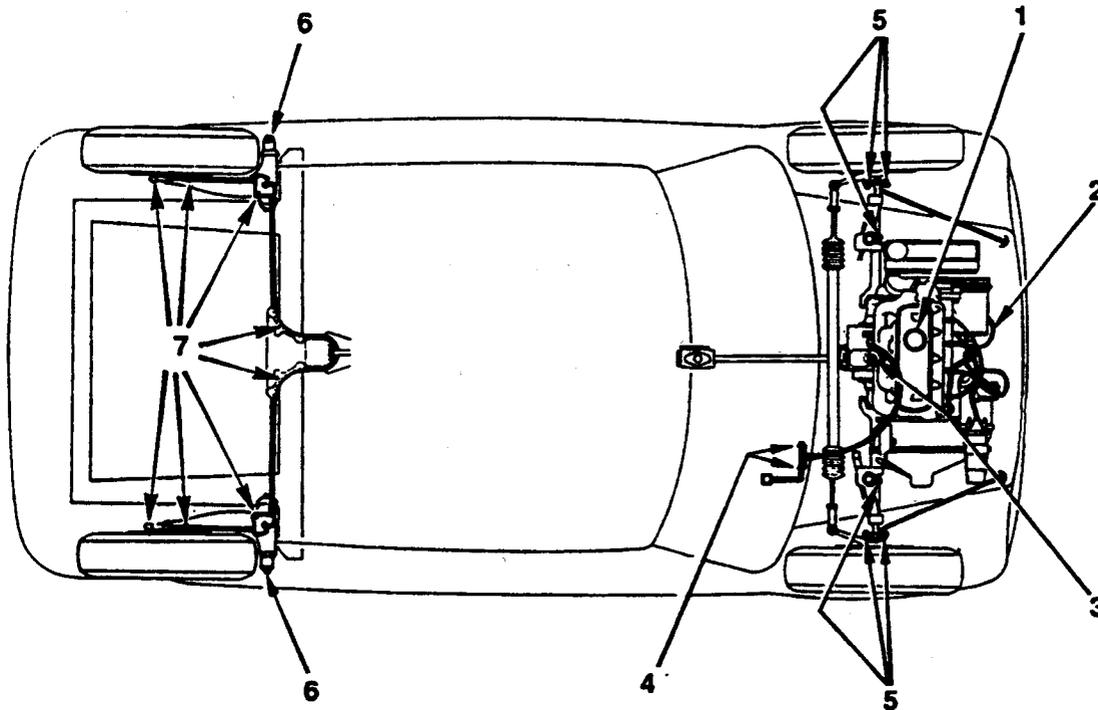

10M0212

LUBRICATION

Ensure that the vehicle is standing on a level surface when checking oil levels.

Every 6,000 miles (10000 km) or 6 months

1. **Engine/gearbox.** Drain off the old oil and refill with new.
 2. **Oil filter.** Fit a new oil filter cartridge, or element - Automatic.
 3. **Carburettor.** Top up the piston damper - Carburettor models only.
 4. **Accelerator.** Lubricate accelerator control linkage and pedal fulcrum.
 5. **Steering joints.** Lubricate as detailed, see **Steering**.
 6. **Rear suspension radius arms.** Lubricate as detailed, see **Suspension**.
 7. **Hand brake.** Lubricate the sector pivots and cable linkages.
 8. **Locks and hinges.** Lubricate the bonnet release and safety catch, and all door locks and hinges.
- Do not oil the steering - column lock.**

For recommended service oils and lubricants, see **INFORMATION - CAPACITIES, FLUIDS AND LUBRICANTS..**



CHECK ENGINE AND TRANSMISSION

1. Visually inspect for oil leaks from the engine and transmission, pay particular attention to areas of gaskets and seal.

ENGINE OIL AND FILTER

Oil level check

Always check oil level and drain oil with the vehicle standing on level ground and use engine oil of specification 10w/40 for topping up and refilling.

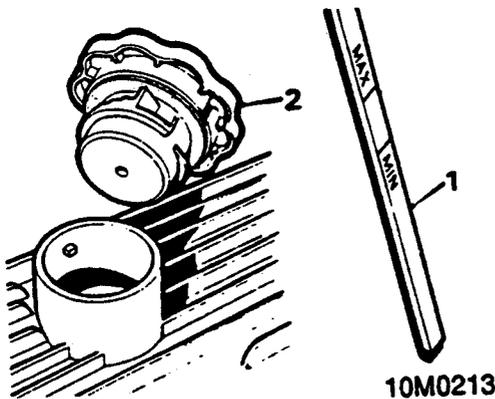

Engine/Manual gearbox

1. Withdraw dipstick and wipe blade. Re-insert dipstick fully, withdraw it and check oil level which must be maintained between the 'MIN' and 'MAX' marks on the dipstick; the difference in quantity between the 'MIN' and 'MAX' marks is approximately 1 pint (0.6 litre).
2. If required, remove filler cap and top-up with new engine oil to specification 10w/40.

Engine/Automatic gearbox

3. Start the engine and run it for 1 - 2 minutes. Stop the engine and wait for one minute, then check the oil level with the dipstick. Maintain the oil level between the 'MIN' and 'MAX' marks on the dipstick; the difference in quantity between the 'MIN' and 'MAX' marks is approximately 1 pint (0.6 litre)
4. If required, remove filler cap and top-up with new engine oil to specification 10w/40.

Oil drain and refill

The oil should be drained when the engine is warm. The oil filter can be renewed while the oil is being drained.

WARNING: Observe due care when draining engine oil as the oil can be very hot.

Prolonged and repeated contact with used engine oil may cause serious skin disorders, wash thoroughly after contact. Keep out of the reach of children.

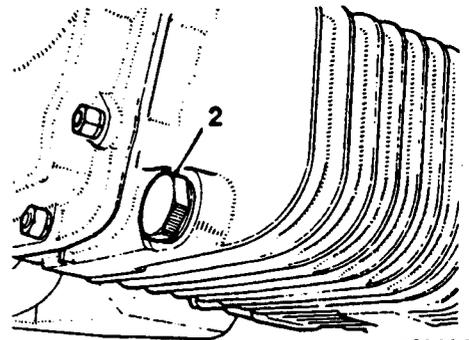

10M0214

1. Place a container beneath the sump.
2. Remove drain plug and sealing washer, allow oil to drain.
3. Clean the magnetic drain plug, fit new sealing washer and refit drain plug. Tighten drain plug to 34 Nm.
4. Remove filler cap, refill with new engine oil to specification 10w/40. Re-check oil level.

Oil filter renewal - Manual gearbox

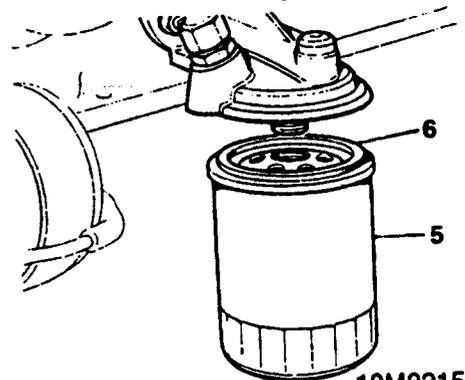

10M0215

5. Clean area around the filter head and place a container beneath the engine. Using a strap wrench unscrew the filter and discard. Wipe surplus oil from the mounting face.
6. Lubricate the seal on new cartridge with engine oil and screw onto the filter head by hand until it seats, then tighten a further half turn only. **TIGHTEN BY HAND FORCE ONLY; DO NOT OVER TIGHTEN.**
7. Refill engine with new oil to specification 10w/40. Start and run engine, check for oil leaks. Stop engine, wait a few minutes, then check oil level and top-up if necessary.

MAINTENANCE

Oil filter element renewal - Automatic gearbox

8. Remove the front grille, see **BODY - Repairs**.

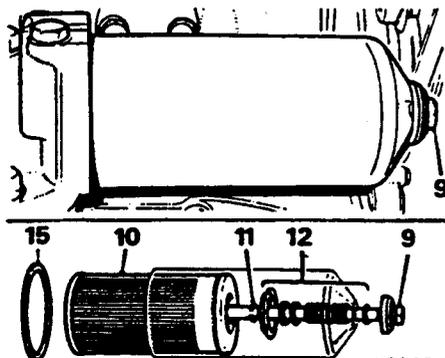

10M0216

9. Unscrew the filter bowl securing bolt and remove the filter assembly.
10. Discard the used element.
11. Remove the circlip from the centre bolt.
12. Withdraw the centre bolt and remove the pressure plate, rubber and steel washers, and the spring.
13. Thoroughly wash the casing and components in a cleaning fluid.
14. Examine the sealing washers, and replace if necessary.
15. Extract the sealing ring from the filter head recess, lubricate and fit a replacement.
16. Reassemble the filter bowl components and fit a new element.
17. Refit the filter assembly; rotate the bowl while tightening to ensure that it is correctly located on the sealing ring. Tighten the retaining bolt to 19 Nm.
18. Refill engine with new oil to specification 10w/40. Start and run engine, check for oil leaks. Stop engine, wait a few minutes, then check oil level; and top - up if necessary.
19. Refit the grille, see **BODY - Repairs**.

Engine ventilation filter

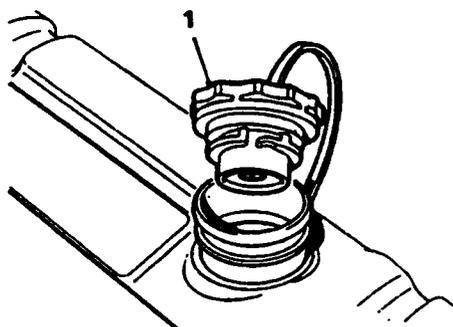

10M0217

1. An air intake filter is incorporated into the oil filler cap which must be renewed as a complete assembly.

DRIVE BELT TENSION

When correctly tensioned, a total deflection of 0.5 in (13 mm) under moderate hand pressure should be possible at the midway point of the belt run between the pulleys.

Adjust

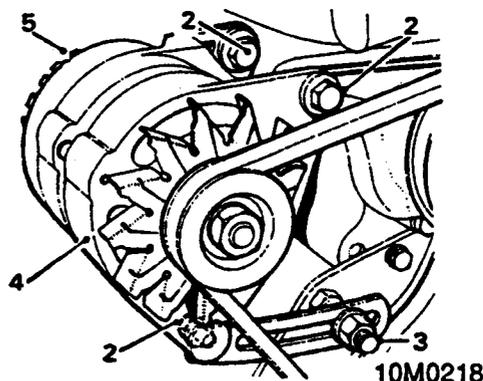

10M0218

1. Remove the ignition shield and check the belt tension using one of the following methods:
 - a Use a torque spanner and apply a load of 11.0 to 11.5 lbf ft (1.5 to 1.6 kgf m) in a clockwise direction to the alternator pulley retaining nut. If the belt tension is correct the belt will slip at this torque loading.
 - b Apply a load of 7.5 to 8.2 lbf (3.3 to 3.6 kgf) at right angles to the belt midway between pulleys. The belt should deflect 0.25 in (6 mm).
2. Slacken the alternator securing bolts.
3. Slacken the adjusting link nut.
4. Move the alternator to the required position; apply any leverage necessary to the drive - end bracket and not to any other part of the alternator. The lever used should preferably be of wood or soft metal. **DO NOT** over-tension.
5. Keep the slots in the plastic cover clean.
6. Tighten the securing nuts and bolts.
7. Fit the ignition shield.

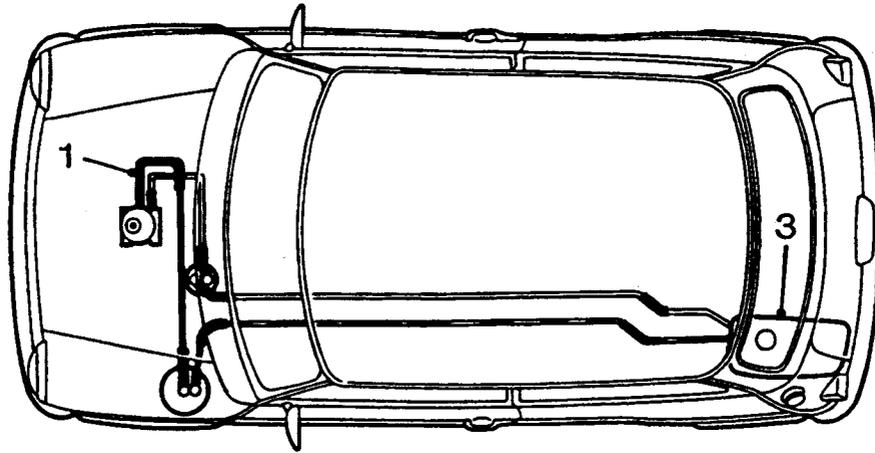

10M0219

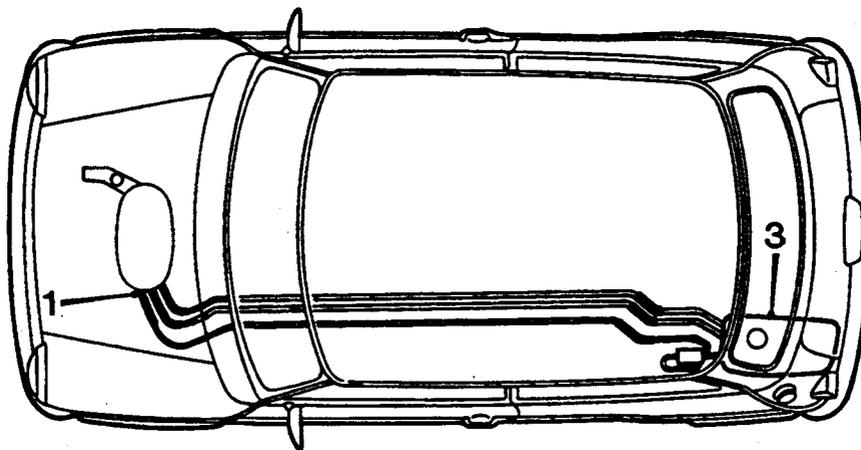
Carburettor models

10M0049

SPi models

FUEL SYSTEM HOSES, PIPES AND UNIONS

1. Check fuel pipes and connections for chafing and leakage.
2. Check pipes are securely clipped.
3. Check fuel tank connections for security.
4. Check fuel tank is free from leaks and corrosion.
5. Check fuel tank for security of fixings.

MAINTENANCE

Renew fuel filter - SPi models

Service Repair No. 19.25.01

1. Raise rear of vehicle.

WARNING: Support on safety stands.

2. Disconnect battery earth lead.

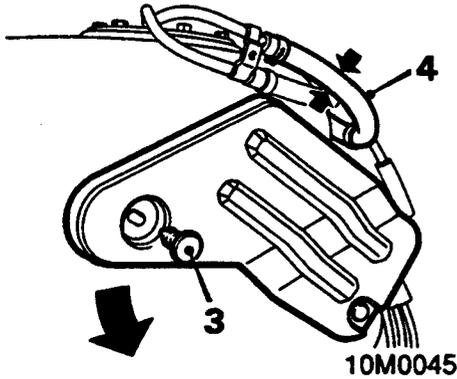

3. Remove top stud securing fuel tank protection cover and pivot cover down to reveal fuel hoses.
4. Fit and tighten clamp to fuel feed hose from tank.
5. Position absorbent cloth under fuel filter inlet.

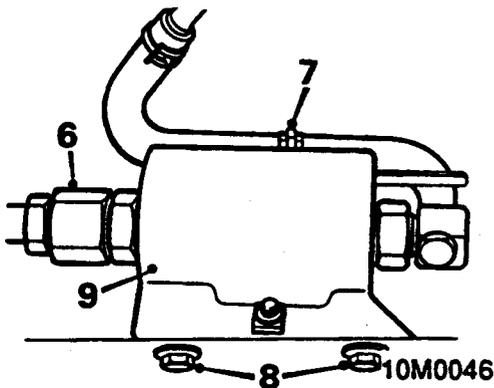

6. Disconnect inlet pipe from fuel filter and plug pipe.
7. Release clip and disconnect fuel filter outlet hose from pipe, plug pipe.
8. Remove 2 bolts, filter bracket to subframe.
9. Remove filter and bracket assembly.

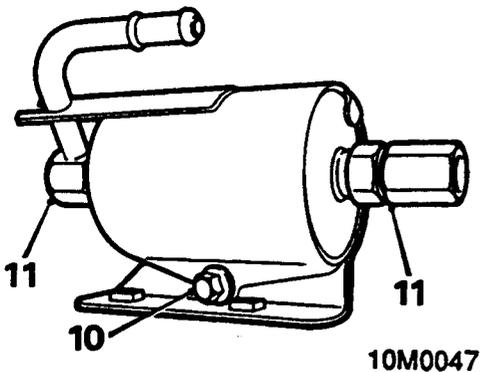

10. Remove clamp bolt and withdraw filter from bracket.
11. Remove outlet pipe and inlet union from filter. Discard filter.

12. Remove plugs from new filter.
13. Fit inlet union and outlet pipe to new filter and tighten union.
14. Fit filter to bracket, locating outlet pipe in locating plate, and tighten clamp bolt.
15. Fit filter and bracket assembly to subframe and tighten bolts.
16. Remove plugs from fuel pipes.
17. Connect filter outlet hose to pipe and secure with clip.
18. Connect inlet pipe to fuel filter and tighten union.
19. Remove clamp from fuel hose.
20. Correctly position tank protection cover and fit stud.
21. Remove stand(s) and lower vehicle.
22. Connect battery earth lead.

VALVE ROCKER ADJUSTMENT

Adjust

1. Remove the rocker cover.

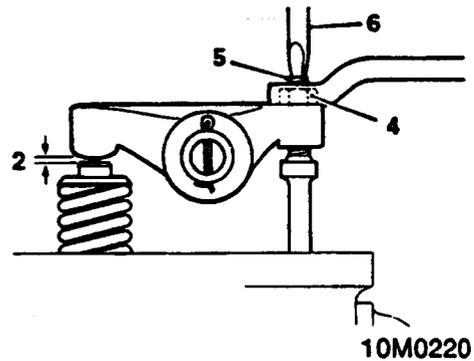

2. Check the clearance between the valve rocker arms and valve stems with a feeler gauge.

Data: Clearance 0.012 in (0.30 mm).

3. Check the clearance of each valve in the following order:

Check No. 1 valve with No. 8 fully open.

Check No. 3 valve with No. 6 fully open.

Check No. 5 valve with No. 4 fully open.

Check No. 2 valve with No. 7 fully open.

Check No. 8 valve with No. 1 fully open.

Check No. 6 valve with No. 3 fully open.

Check No. 4 valve with No. 5 fully open.

Check No. 7 valve with No. 2 fully open.

Note: The gauge should be a sliding fit when the engine is cold.

4. Slacken the locknut.
5. Rotate the screw, clockwise to decrease or anti-clockwise to increase the clearance.
6. Retighten the locknut when the clearance is correct, holding the screw against rotation.
7. Refit the rocker cover.



AIR CLEANER ELEMENT - CARBURETTER

Service Repair No.
Element - 19.10.09

Remove

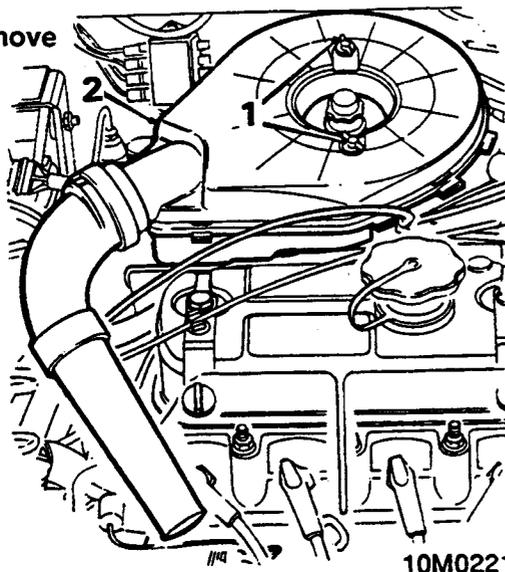

1. Remove 2 wing nuts securing air cleaner to carburetter.
2. Remove air cleaner from carburetter.
3. Remove air cleaner to carburetter seal.

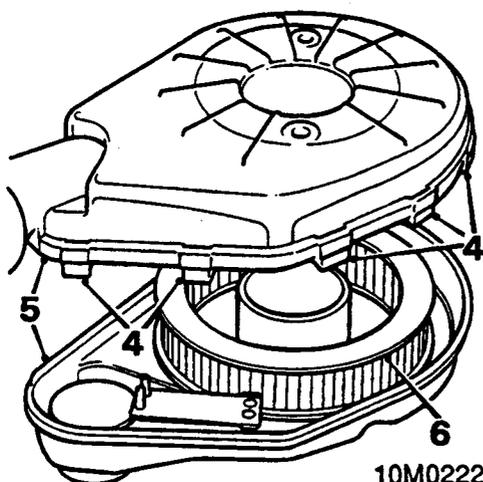

4. Release clips securing 2 halves of the air cleaner body.
5. Separate 2 halves of air cleaner body.
6. Remove air cleaner element.

Refit

1. Fit new air cleaner element.
2. Align 2 halves of air cleaner body and secure with clips.
3. Clean mating faces of air cleaner and carburetter, fit carburetter seal to air cleaner.
4. Position air cleaner to carburetter, ensure the hose between the manifold hot box and air cleaner is properly located.
5. Fit and tighten wing nuts.

AIR CLEANER ELEMENT - SPI

Service Repair No. 19.10.10

Renew

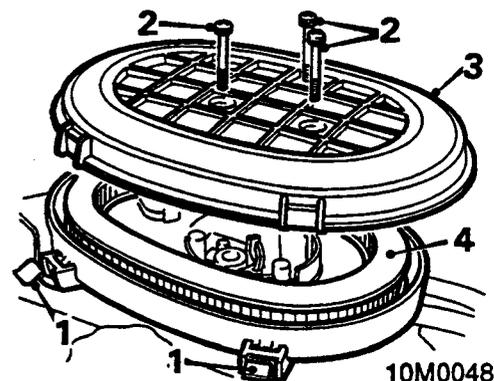

1. Release 4 cover retaining clips.
2. Remove 3 screws from cover.
3. Lift off cover.
4. Remove and discard element.
5. Thoroughly clean body of cleaner and air intake.
6. Fit new element, ensuring it is correctly seated in casing.
7. Fit cover to body.
8. Fit 3 screws to cover. Tighten screws.
9. Engage 4 cover retaining clips.

CARBURETTER PISTON DAMPER

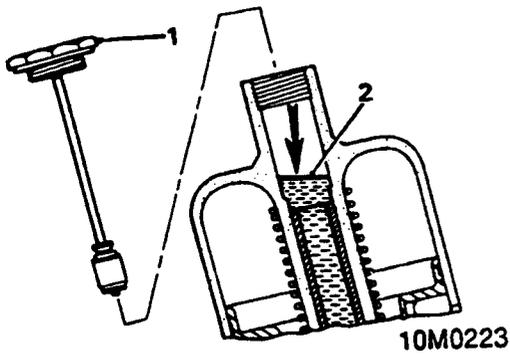

Top up the carburetter piston damper reservoir, using an approved engine oil, see **INFORMATION - CAPACITIES, FLUIDS AND LUBRICANTS**.

CAUTION: Under no circumstances should a heavy-bodied lubricant be used.

1. Remove damper from carburetter dash pot.
2. Top up with oil to bring the level 0.5 in (13 mm) above the top of the damper cylinder.
3. Raise and lower piston, check for free movement without sticking.
4. Fit and tighten damper to dash pot.

SPARK PLUGS RENEW

Service Repair No. 18.20.02

1. *Carburetter models:* Remove air cleaner assembly, see **CARBURETTER & IGNITION**.
2. Release 2 turnbuckles securing splash shield to rocker cover.

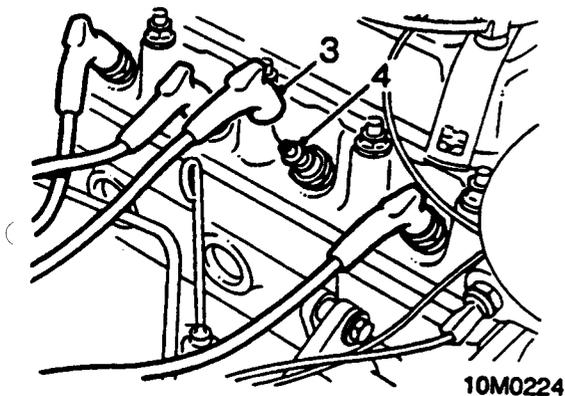

3. Disconnect ht leads from spark plugs.
4. Remove spark plugs using spark plug socket.

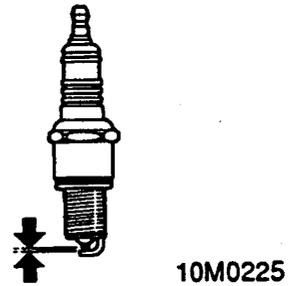

5. Set gap of each new spark plug to 0.85 mm.
6. Fit spark plugs and tighten to 25 Nm.

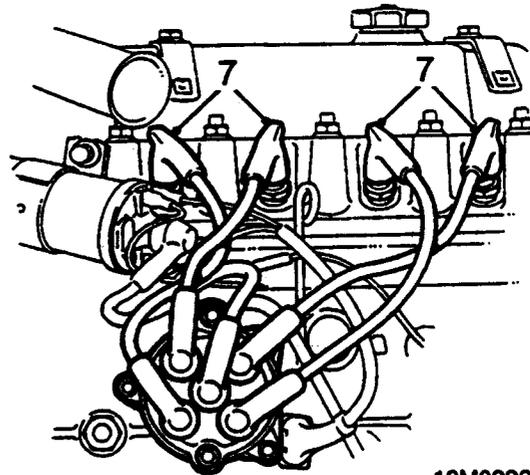

7. Connect correct ht leads to spark plugs.
8. Secure splash shield to rocker cover with turnbuckles.
9. *Carburetter models:* Fit air cleaner assembly, see **CARBURETTER & IGNITION**.



DISTRIBUTOR CAP, HT CABLES AND COIL TOWER

Check

1. *Carburettor models:* Remove air cleaner assembly, see **CARBURETTER & IGNITION**.
2. Release 2 turnbuckles securing splash shield to rocker cover.

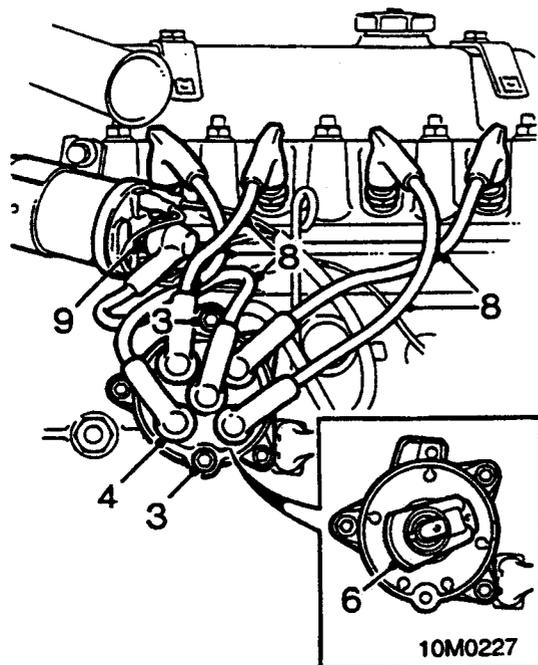

3. Release 2 screws.
4. Lift off distributor cap.
5. Check cap for cracks, warping and burns.
6. Check rotor for damage.
7. Clean interior and exterior of distributor cap.
8. Check that ht cables are free from damage, routed correctly and all connections are tight.
9. Clean ignition coil tower.
10. Refit distributor cap.
11. Tighten distributor cap screws to 2 Nm.
12. Secure splash shield to rocker cover with turnbuckles.
13. *Carburettor models:* Fit air cleaner assembly, see **CARBURETTER & IGNITION**.

IGNITION TIMING - CARBURETTER

Check and adjust

The ignition timing must be set dynamically, using a stroboscopic light.

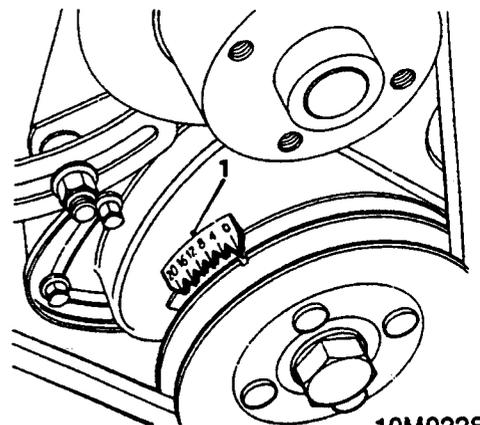

DATA: $5^{\circ} \pm 1^{\circ}$ B.T.D.C. at 1500 rev/min (vacuum disconnected)

1. Apply **WHITE** paint to the timing mark on the crankshaft pulley and to the appropriate timing pointer for clarity.
2. Disconnect the vacuum pipe from the distributor.

Connect the stroboscopic light to No. 1 plug h.t. lead. Timing may now be carried out.

3. Start the engine and check the ignition timing.
4. Slacken the distributor clamp bolt.
5. Carefully rotate the distributor body to achieve the correct timing figure for the given engine speed. Rotate clockwise to advance or anti-clockwise to retard.
6. Tighten the distributor clamp bolt and recheck timing.
7. Connect the vacuum pipe and check vacuum advance.
8. Switch off engine and disconnect stroboscopic light.

ENGINE TUNING - SPI

Tuning on engine with Fuel Injection must be carried out using Microcheck or Cobest.

ENGINE TUNING - CARBURETTOR MODELS

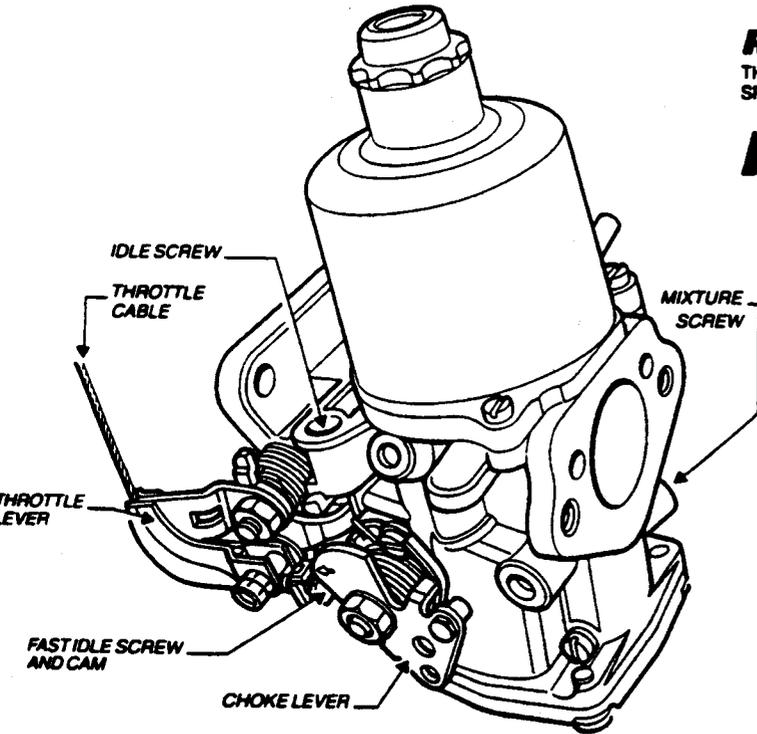

REMEMBER BEFORE YOU START

THE FOLLOWING ITEMS CAN INFLUENCE ENGINE TUNING.
SPARKING PLUGS ● VALVE CLEARANCES ● IGNITION CHARACTERISTICS.

MAKE SURE...

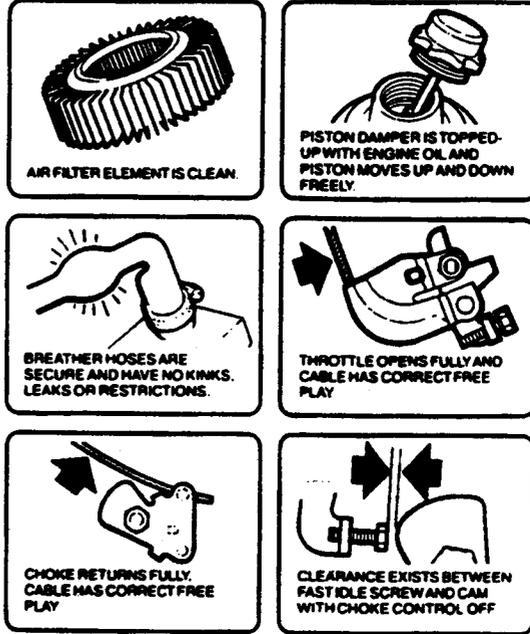

WARM-UP & TUNE

MAKE SURE YOUR TUNING EQUIPMENT IS...
WARMED-UP ● CALIBRATED CORRECTLY ● AVAILABLE FOR IMMEDIATE USE

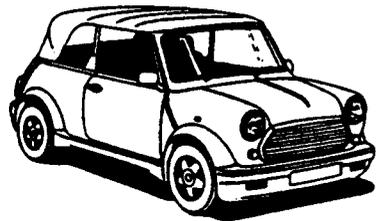

1 DRIVE VEHICLE ON ROAD FOR APPROX 4 MILES TO ATTAIN NORMAL OPERATING TEMPERATURE

TUNING SHOULD BE COMPLETED WITHIN 2 MINUTES OF RETURN, WITHOUT STOPPING THE ENGINE AND BEFORE COOLING FAN OPERATES

2 IF TUNING CANNOT BE COMPLETED WITHIN 2 MINUTES, OR COOLING FAN OPERATES



WAIT FOR FAN TO SWITCH OFF INCREASE ENGINE SPEED TO 2000 RPM FOR 30 SECS AND CONTINUE TUNING

3 ELECTRICAL LOADS

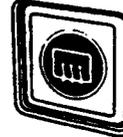

ENSURE ALL ELECTRICAL LOADS ARE SWITCHED OFF

4 CONNECT TACHOMETER

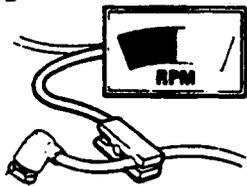

5 IDLE SCREW



TURN TO OBTAIN SPECIFIED IDLE SPEED.

6 REMOVE PLUG FROM SAMPLE PROBE AND FIT ANALYSER PIPE

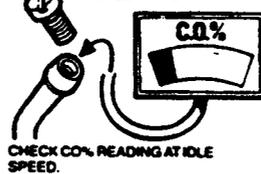

CHECK CO₂ READING AT IDLE SPEED.

7 MIXTURE SCREW



IF NECESSARY, ADJUST BY MINIMUM AMOUNT TO OBTAIN SPECIFIED CO₂. WAIT BETWEEN ADJUSTMENTS FOR READINGS TO STABILISE

8 IDLE SCREW



RE-ADJUST TO OBTAIN SPECIFIED IDLE SPEED

9 CHECKING AND ADJUSTING FAST IDLE SPEED

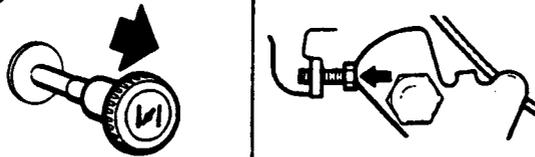

PULL OUT THE CHOKE CONTROL UNTIL ARROW ON CHOKE LEVER ALIGNS WITH FAST IDLE SCREW. TURN SCREW TO OBTAIN SPECIFIED FAST IDLE.

REMOVE EQUIPMENT - TUNING IS NOW COMPLETE.

10M 0127

For Engine tuning figures, see INFORMATION - ENGINE TUNING DATA.



COOLING SYSTEM

Solution	Amount of anti - freeze		Commences freezing		Frozen solid	
	%	Litres	Pts	°C	°F	°C
33 ¹ / ₃	1.2	2.1	-19	-2	-36	-33
50	1.8	3 ¹ / ₄	-36	-33	-48	-53

WARNING: Since injury such as scalding could be caused by escaping steam or coolant, do not remove pressure relief cap from radiator while system is hot. Wait until system has cooled, use a cloth or glove to protect hands from escaping steam.

Check level and top - up

The coolant level should only be checked when the system is cold.

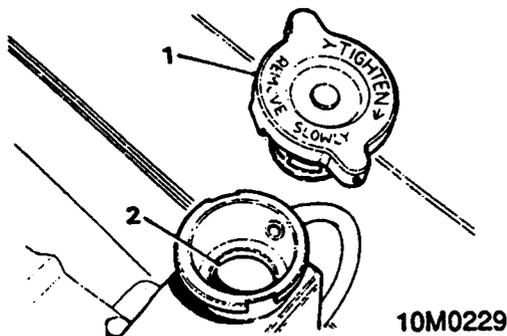

1. Remove the radiator pressure relief cap.
2. Visually check that the coolant level just covers the wire bridge below the filler neck. If the level has fallen appreciably, suspect leakage or overheating.

CAUTION: If coolant is not visible in the radiator the system must be refilled in accordance with Refilling procedure.

3. If required top up with anti - freeze mixture using Unipart Superplus Anti - freeze and water.

CAUTION: The coolant must not exceed the maximum level indication.

4. Check specific gravity of coolant. The overall anti - freeze concentration must not fall below 30% by volume and must not exceed 60% by volume, to ensure that the anti - corrosion properties of the coolant are maintained.
5. Refit radiator pressure relief cap.

Drain and refill

Service Repair No. 26.10.01

1. Visually check engine and cooling system for coolant leaks.
2. Examine hoses for signs of cracking, distortion and security of connections.

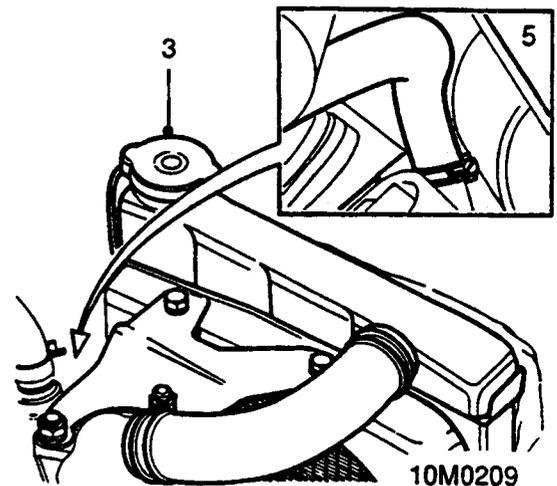

3. Remove radiator pressure relief cap.
4. Position a container to collect drained coolant.
5. Release clip and disconnect hose from radiator and allow coolant to drain.
6. Reconnect radiator bottom hose and tighten clip.
7. Prepare coolant to required concentration.
8. Turn heater temperature control to maximum heat position.
9. Fill system slowly through radiator, gently compressing radiator top hose to expell air, until fluid level just covers the wire bridge below filler neck.
10. Start engine and run until engine reaches normal operating temperature then allow engine to cool.
11. Check for leaks and top - up coolant.
12. Fit radiator pressure releif cap.

MAINTENANCE

EXHAUST SYSTEM

1. Check for damage and signs of leakage.
2. Check security of system.
3. Check mountings and correct alignment.
4. Check security of heat shields.

DRIVE SHAFT GAITERS

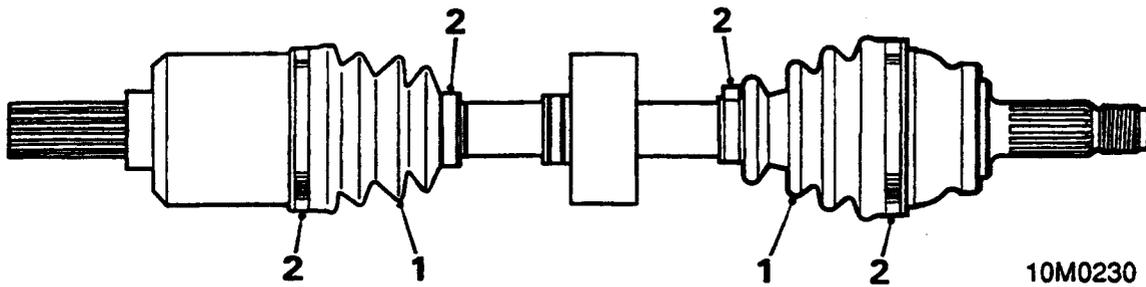

1. Check that drive shaft gaiters are not twisted, split or damaged.
2. Check clips are secure.



GREASE POINTS

Front Suspension

Swivel hub ball joints

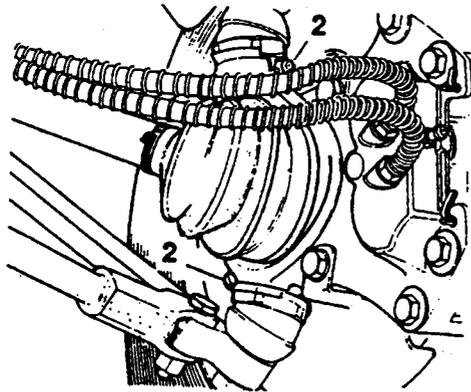

10M0231

1. Raise front of vehicle.

WARNING: Support on safety stands.

2. Clean both grease nipples on each hub.
3. Using a pressure grease gun, feed both grease nipples until no further grease will enter.
4. Clean excess grease from hub.

Upper support arm inner pivot

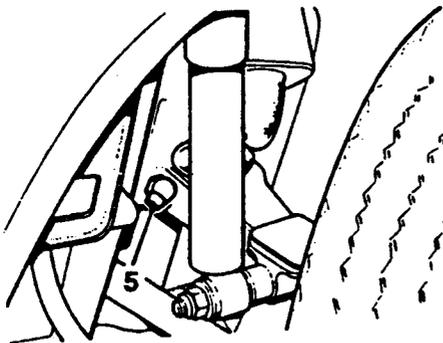

10M0232

5. Clean grease from upper arm grease nipple.
6. Using a pressure grease gun, feed the upper arm grease nipple until no further grease will enter.
7. Clean excess grease upper arm.
8. Remove stand(s) and lower vehicle.

Rear Suspension

Radius arm

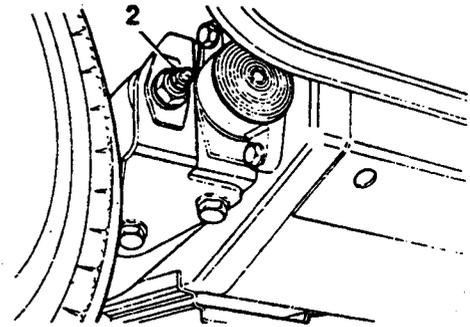

10M0233

1. Raise rear of vehicle.

WARNING: Support on safety stands.

2. Clean radius arm grease nipple.
3. Using a pressure grease gun, feed the radius arm grease nipple until no further grease will enter.
4. Clean excess grease from radius arm.
5. Remove stand(s) and lower vehicle.

STEERING

Checking

1. Examine the steering system for signs of leakage and general condition of gaiters and hoses.
2. Check steering and suspension ball joint for excessive free movement.

Checking front wheel alignment

When checking the front wheel alignment the following points must always be observed, see **INFORMATION - GENERAL DATA** for alignment setting figure.

1. Position the vehicle on a level surface, inflate the tyres to the correct pressures and ensure that the vehicle is at kerbside weight. Any free movement in the steering and suspension ball joints and the suspension arms must be rectified.
2. Set the wheels in the straight ahead position, rock the vehicle from side to side and roll it backwards and forwards at least a vehicle length to relieve any stresses in the steering linkage.

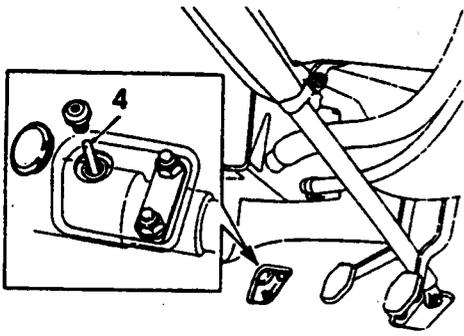

10M0234

3. Remove front carpet from passenger footwell.
4. Remove the grommet from the passenger footwell and unscrew the plastic plug from the steering rack. Centralize the steering rack by inserting a 6 mm (1/4 in) diameter dowel through the rack casing to engage the mating hole in the rack.
5. Using optical wheel alignment equipment available and following the instructions provided with the equipment, obtain figures for the wheel alignment and compare this to the figures given, see **INFORMATION - GENERAL DATA**, and carry out adjustments if required.

CAUTION: If the vehicle is moved, jacked-up or the track rods adjusted during the procedure, the vehicle must again be rocked from side to side and rolled backwards and forwards before taking any more readings.

Adjusting

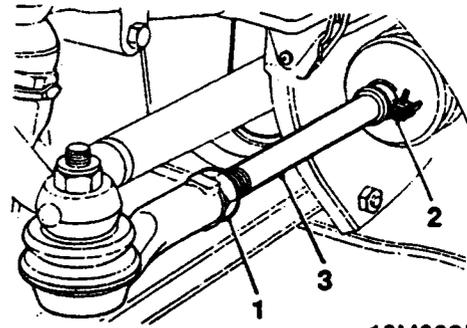

10M0235

1. Slacken the locknut on both tie- rods.
2. Slacken the clip securing the rubber gaiter to the tie- rod.
3. Rotate each tie- rod (both are right- hand thread) in the required direction by an equal amount to correct the misalignment.

CAUTION: It is important that the tie- rods are adjusted to exactly equal lengths.

4. Tighten the tie- rod locknuts to 52 Nm.
5. Tighten the gaiter clips.
6. Re- check the wheel alignment.



ROAD WHEELS AND FASTENINGS

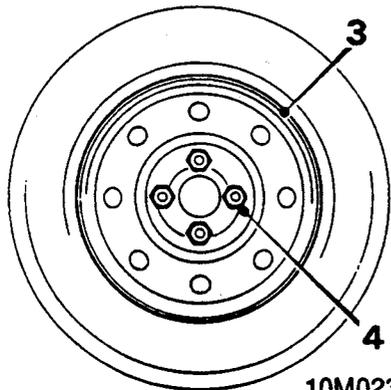

10M0236

1. *Steel wheels:* Slide the wide end of wheel trim remover behind edge of wheel trim. Apply twisting action to tool, at the same time pulling the trim from wheel. Work carefully around trim until it is released.
2. *Alloy wheel:* Wheels can be removed without disturbing hub cover.
3. Check condition of road wheels including spare for signs of buckling and rim damage.
4. **Working in a diagonal sequence slacken each nut 1/2 turn and then tighten to 60 Nm.**
5. *Steel wheel:* Refit wheel trim, ensuring valve stem locates between stem guides. Use firm pressure around edge to push trim securely into position.

TYRE PRESSURES AND CONDITION

1. Check for signs of tyre wear indicator in tread pattern.
2. Check all tyres including spare for uneven wear, external cuts in fabric, exposure of ply or cord structure, lumps and bulges.
3. Check and adjust tyre pressures.
Tyre pressures (cold) Front and rear:
145/70 S12.....2.0 bar 28 lbf/in²
165/60 S12.....2.1 bar 30 lbf/in²

FOOTBRAKE

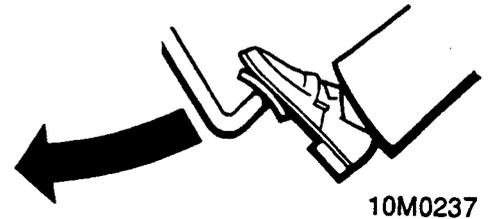

10M0237

1. Press brake pedal and check for firm resistance after short pedal movement.

BRAKE SERVO AIR FILTER

Renew

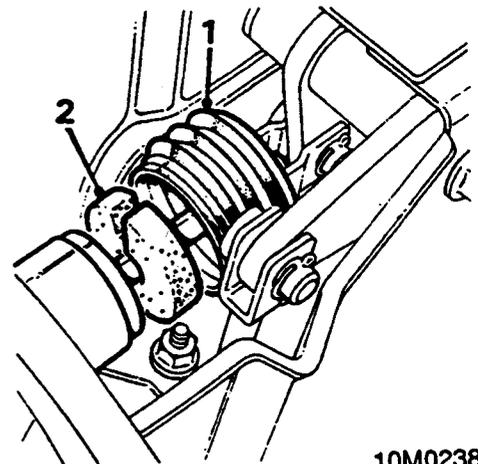

10M0238

1. Release the rubber boot from the servo body and slide it rearwards along the brake pedal push rod.
2. Withdraw the filter pad from inside the servo body.
3. Using a sharp knife, cut a slot in the replacement filter pad from the centre of the pad to its outer edge.
4. Locate the filter pad on the brake pedal push rod and position the pad in the servo body.
5. Refit the rubber boot.

BRAKES

Brake and clutch hoses and pipes

Check visually all hoses, pipes and unions for chafing, leaks and corrosion. It is most important that hoses are not subjected to stress and are not positioned near to other components so that chafing can occur.

Rectify any leaks and replace hoses and pipes showing signs of damage or deterioration - additional work.

Preventive maintenance

In addition to the recommended periodical inspection of brake components it is advisable as the car ages, and as a precaution against the effects of wear and deterioration, to make a more searching inspection and renew parts as necessary.

It is recommended that:

1. Disc brake pads, drum brake linings, hoses and pipes should be examined at intervals no greater than those laid down in the Service Maintenance Schedule.
2. Brake fluid should be changed completely every 24 months regardless of mileage.
3. All flexible hoses and seals in the hydraulic system should be examined and renewed if necessary every 12 months. At the same time the working surface of the pistons and of the bores of the master cylinder, wheel cylinders, and other slave cylinders should be examined and new parts fitted where necessary.

Care must be taken always to observe the following points:

- Do not allow dirt or foreign matter to enter reservoir when topping - up.
- At all times use only new recommended brake fluid from a sealed container, see **INFORMATION - CAPACITIES, FLUIDS AND LUBRICANTS**.
- Never leave brake fluid in unsealed containers. Brake fluid is a hygroscopic liquid and will readily absorb moisture which can be dangerous if then used in the brake system.
- Do not allow brake fluid to contact paint finished surfaces as paint may be damaged. If spilled, remove fluid and clean area with clean warm water.
- Fluid drained from the system should be discarded and NOT re-used.

FRONT BRAKE PADS

Inspecting front brake pads and discs

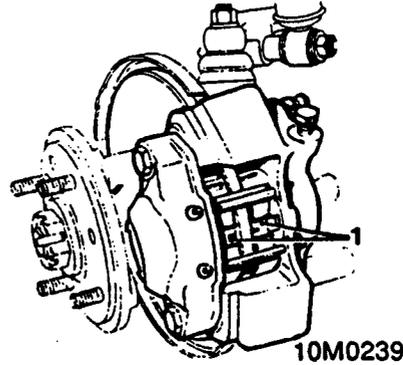

1. Raise front of vehicle.

WARNING: Support on safety stands.

2. Remove road wheels.
3. Visually check the thickness of the brake pad linings.

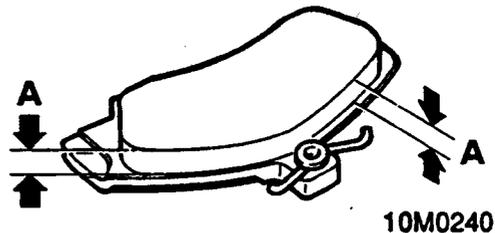

Minimum brake pad thickness:
Dimension A = 1.6 mm ($1/16$ in)

Note: Measurement does not include pad backing thickness.

CAUTION: Ensure that sufficient pad material remains to allow the car to run until its next service.

4. Replace brake pads if necessary, see **BRAKES - Repairs**.

WARNING: Do not use an airline to blow dust from the brake assemblies - asbestos dust can be a dangerous to health if inhaled. Use methylated spirit or denatured alcohol to wash dust from components. Do not use any petroleum - based fluids.

5. Examine the disc for cracking or scoring.

Adjust

Note: Front brake adjustment is made automatically during operation of the foot brake.



REAR BRAKE LININGS

Inspecting rear brake linings

1. Raise rear of vehicle.

WARNING: Support on safety stands.

2. Remove road wheel(s).
3. Release handbrake and slacken rear brake adjusters.
4. Remove the brake drum locating screws and remove drums.
5. Examine the brake linings for wear or contamination. Wash out accumulated dust from the backplate assembly and the drum with methylated spirits (denatured alcohol) and allow to dry. Examine the drum for signs of cracking and scoring.

WARNING: Do not use an airline to blow dust from the brake assemblies - asbestos dust can be dangerous to health if inhaled.

6. Inspect the linings for wear; if the lining material has worn down to the minimum permissible thickness of 1/16 in (1.6 mm) on bonded type shoes, or close to the rivets, the brake linings must be renewed, see **BRAKES - Repairs**.
7. Examine the wheel cylinder for signs of leakage and rectify if necessary.
8. Lubricate contact faces of strut and handbrake lever with Girling brake grease, ensure they pivot freely.
9. Lubricate tips of shoes, shoe platforms on backplate and contact areas of adjuster, strut and backplate with Girling brake grease.

CAUTION: Keep grease away from shoe linings and all hydraulic parts.

10. Inspect drum for cracks, score marks and corrosion. If serviceable remove any rust with a wire brush and wipe inside of drum with a damp cloth.

Adjusting rear brakes

Service Repair No. 70.25.03

1. Raise rear of vehicle.

WARNING: Support on safety stands.

2. Release handbrake and check that the rear road wheels rotate freely.

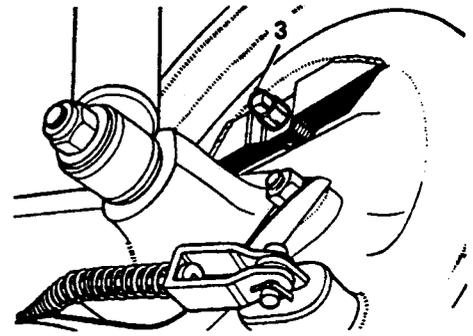

10M0241

3. Using tool **18G 619A**, turn adjuster on rear brake backplate anti-clockwise, viewed from road wheel side, until road wheel just locks.
4. Pump footbrake pedal several times and check that the road wheels are still locked.
5. Turn adjuster counter-clockwise until road wheel just rotates freely.
6. Repeat procedure for other side of vehicle.
7. Remove stands and lower vehicle

BRAKE AND CLUTCH FLUID LEVEL

WARNING: Do not allow dirt or foreign matter to enter reservoir when topping - up.

At all times use only new recommended brake fluid from a sealed container, see **INFORMATION - CAPACITIES, FLUIDS AND LUBRICANTS..**

CAUTION: Never leave brake fluid in unsealed containers. Brake fluid is a hygroscopic liquid and will readily absorb moisture which can be dangerous if then used in the brake system.

CAUTION: Do not allow brake fluid to contact paint finished surfaces as paint may be damaged. If spilled, remove fluid and clean area with clean warm water.

Level check

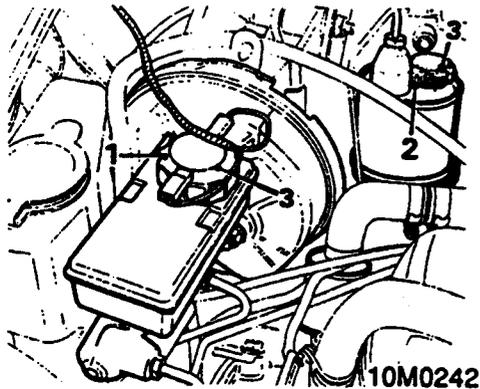

1. **BRAKE:** Check the fluid level in the reservoir the fluid must be maintained to the level mark on the reservoir.
2. **CLUTCH:** Remove the filler cap and check the fluid level in the reservoir, the fluid level must be maintained to the bottom of the filler neck.
3. If necessary, remove the filler cap and add fluid until it reaches the correct level. Refit the filler cap.

Note: The need for frequent topping - up is indicative of a leak in the hydraulic system which must be found and rectified immediately.

BRAKE FLUID

Fluid renew

CAUTION: Never re-use fluid that has been bled from the system. Do not allow the fluid level to fall so low that air can enter the system during bleeding. Check reservoir fluid level frequently during bleeding operation and top - up as necessary. Do not fill above the MAX mark.

CAUTION: Do not allow brake fluid to contact paint finished surfaces as paint may be damaged. If spilled, remove fluid and clean area with clean, warm water.

WARNING: Absolute cleanliness must be maintained, do not allow dirt or foreign liquids to enter reservoir when topping - up.

Use only AP Premium Super DOT 4 or Castrol Universal DOT 4 brake fluid from airtight containers.

1. Raise front and rear of vehicle.

WARNING: Support on safety stands.

2. Adjust rear brakes, see **Rear brake linings.**
3. Check that all pipe and hose connections are tight and bleed screws are closed.
4. Top up the master cylinder reservoir with recommended brake fluid, see **INFORMATION - CAPACITIES, FLUIDS AND LUBRICANTS.**

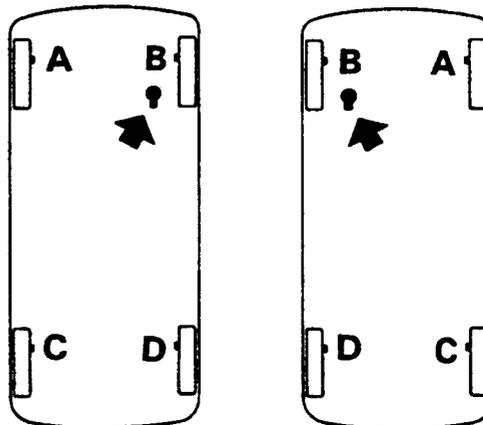

10M0243

RHD

LHD

Note: Carry out operation in sequence shown.

5. Attach a bleed tube to the front bleed screw A and submerge the free end in a transparent container containing clean brake fluid. Start bleeding the system working round the vehicle in sequence shown.
6. Open the bleed screw three - quarters of a turn.
7. Depress the brake pedal to the floor, keep pedal depressed for a few seconds then release allowing pedal to return unassisted.
8. Repeat this action until a flow of clean, air free fluid is obtained. Use an assistant to



tighten the bleed screw to 9 Nm at the end of a downward stroke.

CAUTION: Ensure that fluid level in reservoir is maintained during bleed by topping up with new brake fluid.

9. Repeat the procedure at each bleed screw in sequence.
10. Apply working pressure to the brake pedal for two minutes during which time examine the entire system for leaks and that brake pedal travel does not increase.
11. Top - up fluid in master cylinder reservoir to correct level, fit filler cap.
12. Drive the vehicle and test the brakes. Pedal travel should be short and feel solid with no indication of sponginess.

HANDBRAKE CABLE ADJUST

Service Repair No. 70.35.10

Adjust

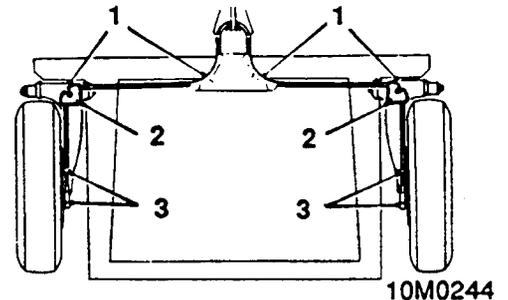

1. Smear grease around the cable guide channels.
2. Lubricate the swivel sector pivots with oil.
3. Smear grease around the operating lever clevis pin and the cable adjacent to the spring anchor brackets.
4. Adjust the rear brake shoes, see **Rear brake shoes adjust**.

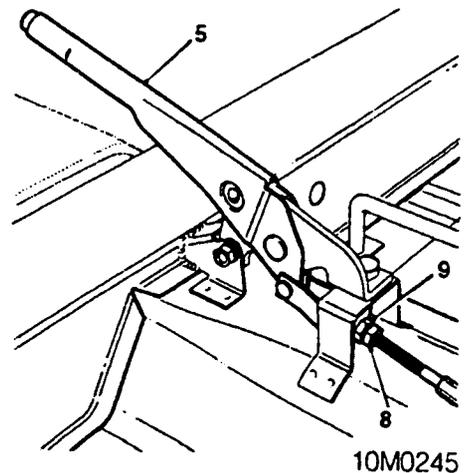

5. Apply the handbrake lever until the third tooth on the ratchet is heard to engage.
6. Check for braking effect on the rear wheels; the adjustment is correct if each wheel can only just be rotated by heavy hand pressure.
7. If adjustment is required, tilt the front seats forward and pull back the floor covering.
8. Slacken the cable locknut.
9. Turn the adjusting nut in the required direction until the correct tension is achieved.
10. Tighten the locknut.
11. Check the handbrake operation, release the handbrake and check that both rear road wheels rotate freely.
12. Replace floor covering.
13. Remove stand(s) and lower vehicle.

WINDSCREEN WASHER

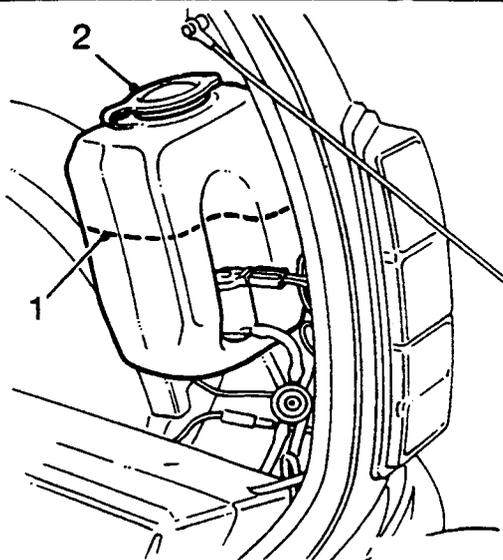

10M 0246

1. Visually check mixture level in reservoir.
2. Top - up by removing filler cap and adding mixture of water and 'Screenwash' at required concentration.

Reservoir capacity	Temperature °C		
	-3°	-7°	-12°
2.1 litre	210 ml	420 ml	840 ml

3. Clean windscreen washer jets using thin wire as a probe.

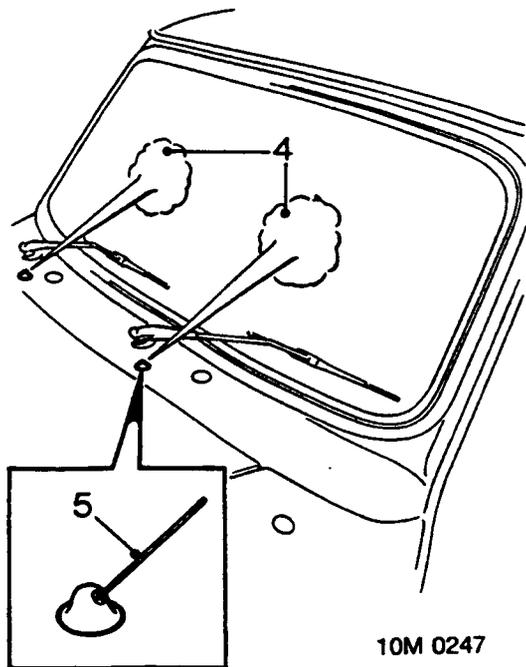

10M 0247

4. Operate windscreen washer and check that the jet strikes centre of area to be wiped.
5. Adjust jet by inserting a needle into jet hole and repositioning.
6. Recheck level in reservoir after adjustments.

SCREEN WIPERS AND BLADES

Check

1. Operate front screen wiper.
2. Check that blades wipe screen without smearing.
3. Check that wipers park correctly.
4. Operate wiper switch in all modes.
5. Check that wipers operate at speeds selected.

Renew blade

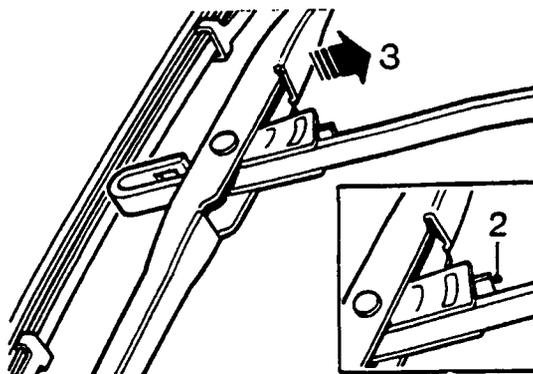

10M 0248

1. Lift wiper arm.
2. Press retaining lever.
3. Slide blade down arm.
4. Withdraw blade assembly from arm.
5. Position new blade to wiper arm.
6. Push blade into engagement with arm.
7. Check that it is retained.



LAMPS, HORNS AND WARNING INDICATORS

1. Switch on sidelamps and check that sidelamps, headlamps in the dipped mode, tail lamps, rear number plate lamps, panel illumination lamps and panel sidelamp indicators illuminate.
2. Switch on headlamps and check that headlamps, tail lamps and rear number plate lamps illuminate.
3. Operate dip switch and check that headlamp dip and main beams and panel main beam indicators illuminate.
4. Operate flash switch and check that headlamps flash.
5. Switch on ignition.
6. Open doors and check that interior light illuminates.
7. Press horn and check that horn operates.
8. Operate direction warning indicator switch to right and left and check that warning indicators flash at front and rear.
9. Operate hazard warning switch and check that all warning indicators flash.

BATTERY CONNECTIONS

The battery is situated in the luggage compartment.

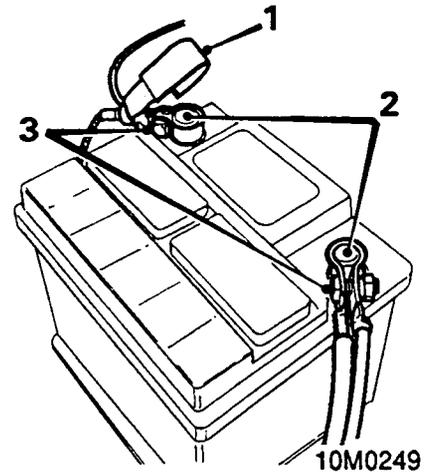

1. Pull back flexible protector on terminal.
2. Wipe battery top clean and dry, smear terminal posts with petroleum jelly.
3. Ensure terminals are tight.
4. Replace protector.

ROAD TEST

Starter inhibitor switch – automatic

1. Select 'D' gear lever position.
2. Check that engine will not start.
3. Select 'R' gear lever position and repeat start check.
4. Check that engine will start in 'P' and 'N' positions.

Selector and kick – down cables – automatic

1. Check for correct setting of gear selector cable and kick – down overcheck.

Engine start and fast idle speed

1. Start engine from cold and check that fast engine idle speed is maintained until normal engine temperature is reached.

Engine performance and throttle operation

1. Start engine and check that it starts easily.
2. Check that 'oil pressure' and 'no charge' warning lamps extinguish.
3. Check that throttle pedal movement is free and unrestricted.
4. Check that engine is responsive to throttle movement.

Clutch and gear selection – Manual. Normal driving conditions

1. Check that clutch engages smoothly without judder, slipping or noise.
2. Check for abnormal transmission noise.
3. Check for smooth quiet gear change and that gear selected engages easily.

Gear change and parking pawl engagement – automatic. Normal driving conditions

1. Select 'R' and check for smooth take up.
2. Select 'D' and check for smooth up – changes of ratio from rest.
3. Check operation of kick – down by driving vehicle at approximately 30 mph (50 km/h) and pressing throttle pedal quickly and firmly to the floor. Automatic down – change should operate.
4. Slow down vehicle and check for smooth down – changes of ratio.
5. Stop vehicle on a slope.
6. Select 'P' and release handbrake.
7. Check that vehicle does not move and that selector does not slip out of 'P'.
8. Carry out a similar check with vehicle facing in the opposite direction.

Steering

1. Check for noise, effort required, free play and self – centralism.

Suspension

1. Check for noise, irregularity in ride (e.g dampers) and wheel imbalance.

Footbrake

1. Check for pedal effort, travel, braking efficiency, pulling and binding.

Instruments

1. Check that all instruments operate.
2. Check speedometer for steady operation, noise and operation of distance recorder.

Body

1. Check for abnormal body noise.

Seat belts

1. Check for operation of inertia reels and condition of belt webbing.

Handbrake

1. Apply handbrake firmly, check travel and ratchet hold and release.

ENGINE

CONTENTS

Description and Operation

	Page
Engine components	3
Description	4

Adjustments

	Page
Crankshaft primary gear end - float	1

Repairs

	Page
Engine and gearbox	1
Cylinder head	10
Crankshaft	15
Connecting rods and pistons	18
Camshaft	22
Oil pump	23
Distributor drive shaft	24
Flywheel housing	25
Flywheel housing oil seal	26
Main bearing cap oil seal	27
Crankshaft pulley	27
Timing chain and gears	29
Timing cover and oil seal	30
Rocker cover	31
Rocker shaft assembly	31
Tappets	32
Oil pressure relief valve	33
Engine left - hand mounting	33
Engine right - hand mounting	34
Flywheel and starter ring gear	34



ENGINE

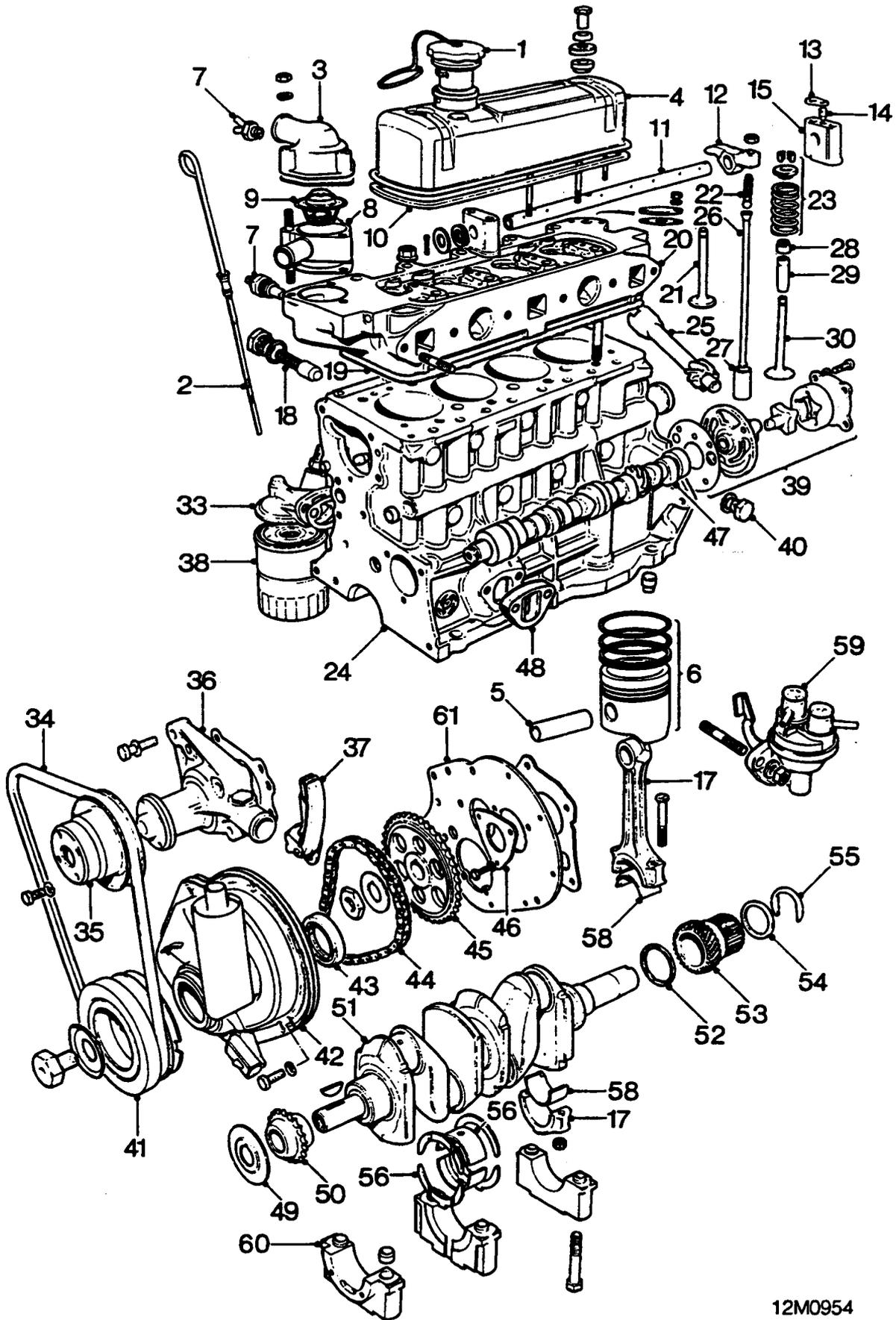

12M0954



ENGINE COMPONENTS

1. Oil filler cap
2. Dipstick
3. Coolant outlet elbow
4. Rocker cover
5. Gudgeon pin
6. Piston and rings
7. Temperature sensor - (carburettor models)
8. Thermostat housing
9. Thermostat
10. Rocker cover gasket
11. Rocker shaft
12. Valve rocker
13. Lock plate
14. Rocker shaft locating screw
15. Rocker shaft bracket
16. Hot air intake box
17. Connecting rod and cap
18. Oil pressure relief valve
19. Cylinder head gasket
20. Cylinder head
21. Exhaust valve
22. Rocker adjusting screw
23. Valve spring, cap and cotters
24. Cylinder block
25. Distributor drive shaft
26. Push - rod
27. Tappet
28. Inlet valve seal
29. Valve guide
30. Inlet valve
31. Manifold gasket
32. Inlet and exhaust manifold
33. Oil filter head
34. Drive belt
35. Coolant pump pulley
36. Coolant pump
37. Chain tensioner
38. Oil filter
39. Oil pump
40. Cylinder block drain plug (if fitted)
41. Crankshaft pulley
42. Timing cover and oil separator
43. Timing cover oil seal
44. Timing chain
45. Camshaft sprocket
46. Camshaft locating plate
47. Camshaft
48. Fuel pump insulator block - (carburettor models)
49. Crankshaft oil thrower
50. Crankshaft sprocket
51. Crankshaft
52. Thrust washer
53. Crankshaft primary gear
54. Backing ring
55. 'C' shaped thrust washer
56. Crankshaft thrust washer
57. Main bearing
58. Big - end bearing
59. Fuel pump - (carburettor models)
60. Main bearing cap
61. Engine front plate
62. Thermal vacuum switch

ENGINE

DESCRIPTION

The engine/transmission unit is supported transversely in a front sub - frame.

Bolted directly on top of the gearbox, the four cylinder overhead valve engine has a chain driven camshaft which drives the distributor and oil pump, the oil pump being mounted at the rear end of the camshaft. The connecting rods have horizontally split big - ends.

Drive is transmitted to the gearbox by a train of helical gears and through the differential mounted on the rear of the gearbox to the front wheels by drive shafts and constant velocity joints.



CRANKSHAFT PRIMARY GEAR END - FLOAT

Service Repair No. 12.21.28.

Check/adjust

Check

1. Remove clutch/flywheel, see **CLUTCH**.

CAUTION: SPi models, care must be taken not to damage the crankshaft sensor.

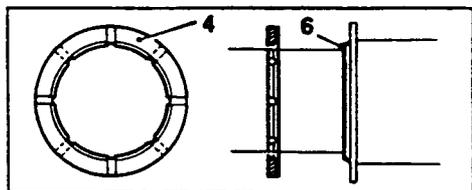
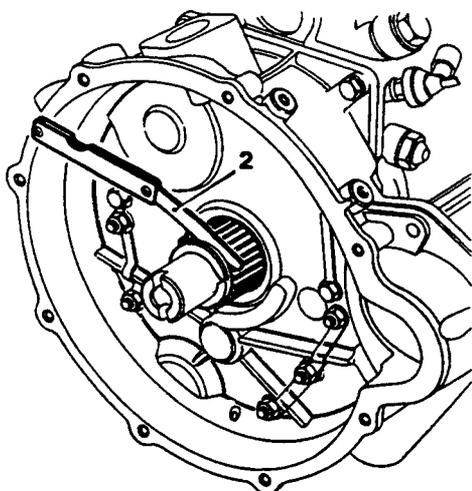

12M0955

2. Check primary gear end - float with feeler gauges between the backing ring and the primary gear.

DATA: End - float = 0.089 to 0.165 mm.

Adjust

3. Remove flywheel housing oil seal.
4. Remove primary gear front thrust washer and measure its thickness.
5. Select a thrust washer which will give the correct end - float figure.

Note: Thrust washers are available in sizes from 2.79 mm to 3.04 mm in steps of 0.05mm.

6. Grease the selected washer and fit it with the chamfered inner edge against the crankshaft.
7. Fit primary gear (without the oil seal), backing ring and the 'C' shaped rear thrust washer.
8. Re - check that end - float is now within tolerance.
9. Remove 'C' shaped rear thrust washer, backing ring and primary gear.
10. Fit flywheel housing oil seal.
11. Fit clutch/flywheel, see **CLUTCH**.





ENGINE AND GEARBOX

Service Repair No. 12.37.01.

Remove

1. Disconnect battery earth lead.
2. Raise front of vehicle.

WARNING: Support on safety stands.

3. Remove bonnet, see **BODY**.
4. Release fasteners and remove splash shield.

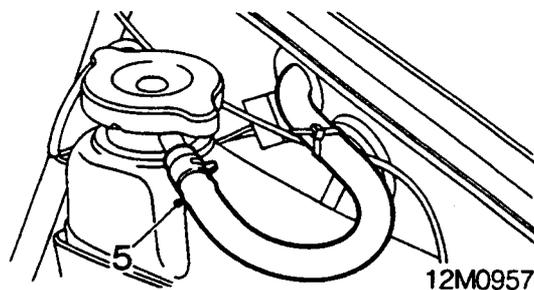

5. Disconnect coolant expansion hose.
6. Remove air cleaner, see **MAINTENANCE**.

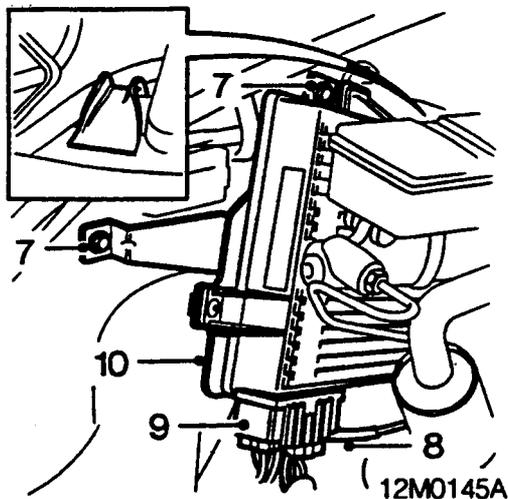

SPi models

7. Remove 2 screws securing ECU to valance.
8. Disconnect vacuum pipe from ECU.
9. Disconnect multiplug from ECU.
10. Remove ECU.

All models

11. Remove master cylinder and brake pipes, see **BRAKES**.
12. Remove brake servo, see **BRAKES**.
13. Plug pressure reducing valve where 2 pipes have been disconnected.

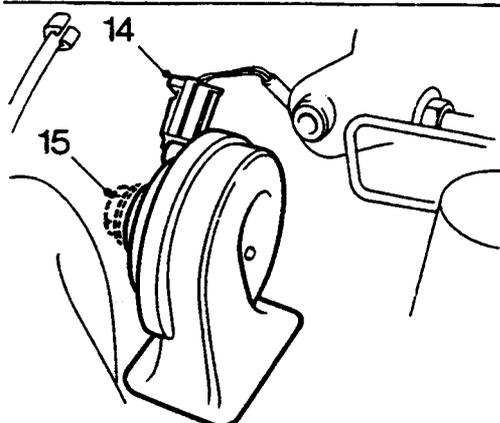
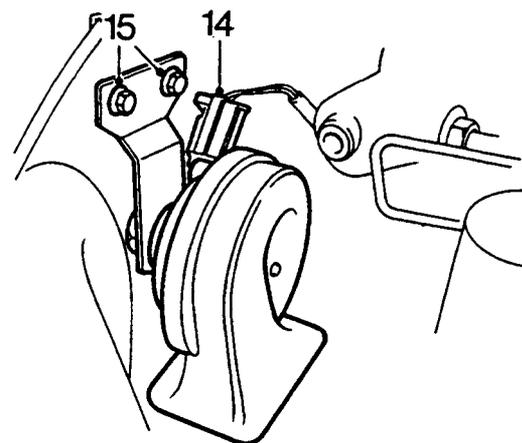

14. Disconnect Lucar from horn.
15. *SPi models:* From under wing remove nut securing horn.
Carburettor models: Remove 2 nuts securing horn.
16. Remove horn.

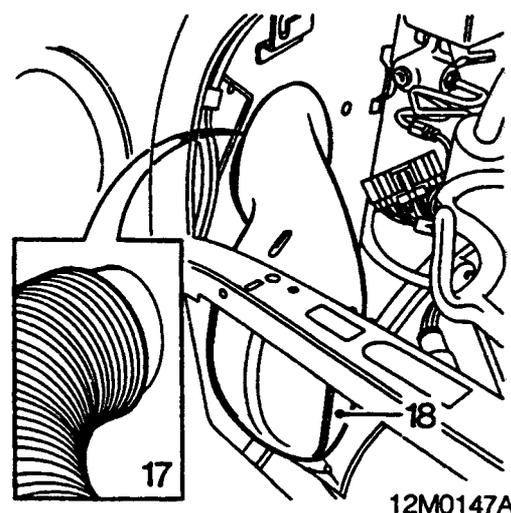

17. Release fresh air intake hose from duct.
18. Release and remove fresh air intake duct from RH valance.

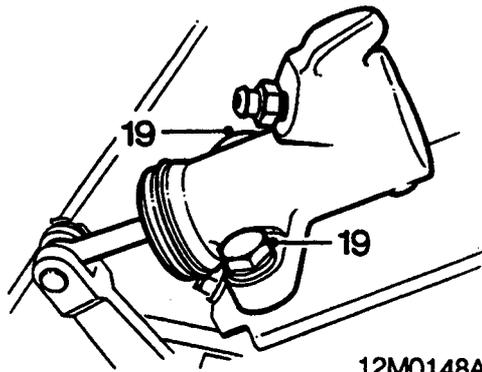

12M0148A

19. *Manual gearbox models:* Remove 2 bolts securing clutch slave cylinder to bracket and move slave cylinder aside.

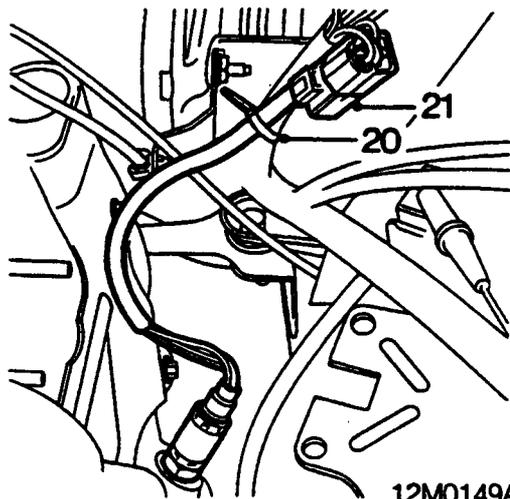

12M0149A

SPi models

20. Remove cable tie securing oxygen sensor lead to engine harness.
21. Disconnect multiplug from oxygen sensor.

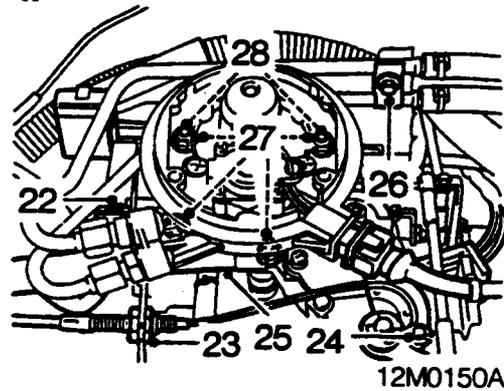

12M0150A

22. Disconnect multiplug from throttle potentiometer.
23. Release throttle cable from abutment bracket.
24. Disconnect throttle inner cable from cam.
25. Disconnect breather hose from throttle body.
26. Remove screw from fuel pipe clip and remove clip.
27. Remove 4 nuts securing throttle body to inlet manifold.
28. Lift fuel pipe bracket from manifold studs.

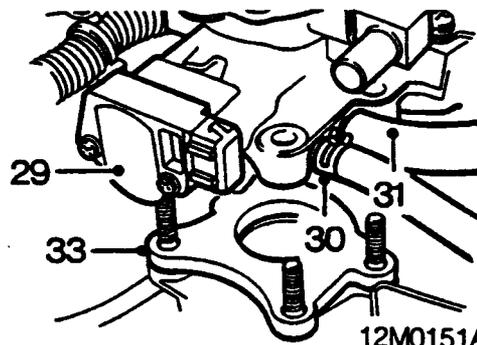

12M0151A

29. Lift throttle body from manifold studs
30. Release clip and disconnect purge hose from throttle body.
31. Disconnect breather hose from throttle body.
32. Move throttle body aside.
33. Remove throttle body spacer from studs.

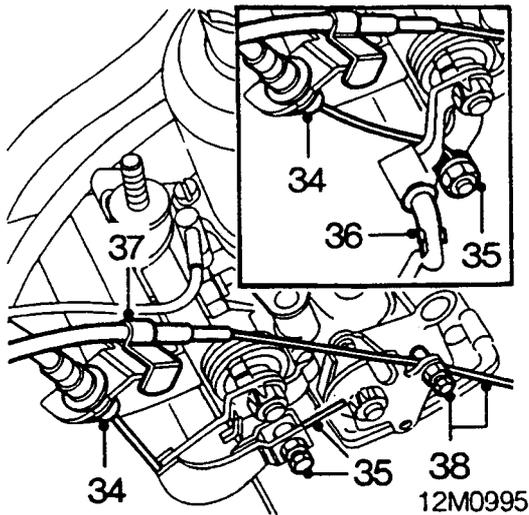

Carburettor models

34. Release throttle cable from abutment bracket.
35. Slacken throttle cable trunnion and release throttle cable.
36. *Automatic gearbox models:* Disconnect down shift rod from throttle lever.
37. Release clip securing mixture control outer cable to abutment bracket.
38. Slacken mixture control cable trunnion and release mixture control cable.

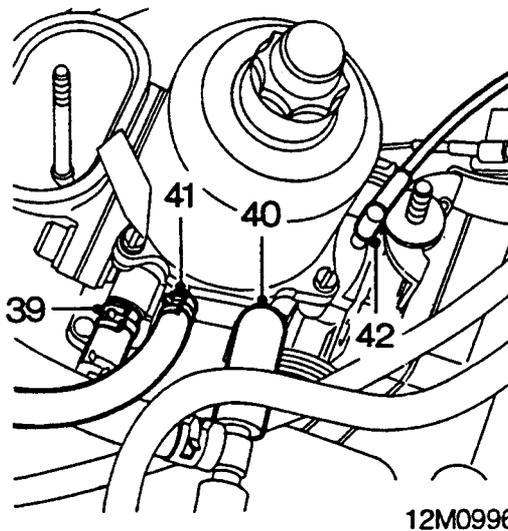

39. Release clip and disconnect fuel hose from carburetter.
40. Disconnect the engine breather hose.
41. Release the fuel return hose from the carburetter assembly.
42. Disconnect the vacuum advance pipe.

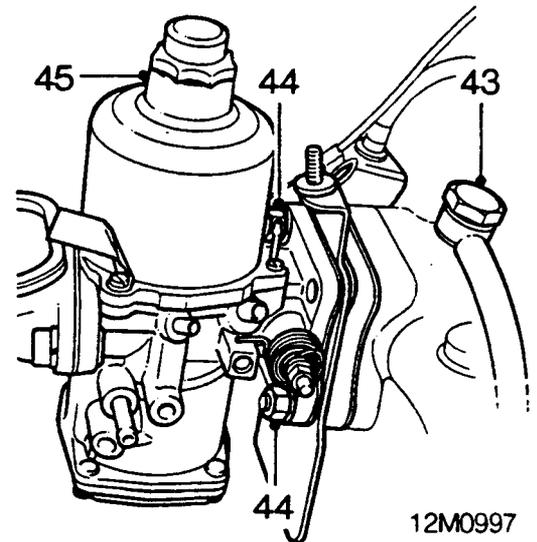

43. Remove servo banjo bolt from manifold and collect 2 washers.
44. Remove 2 nuts and spring washers securing carburetter to manifold.
45. Remove carburetter.

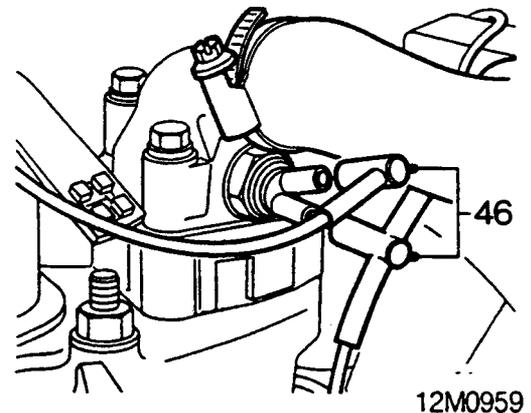

46. Disconnect vacuum pipes from the thermal vacuum switch.

Note: Fitted positions.

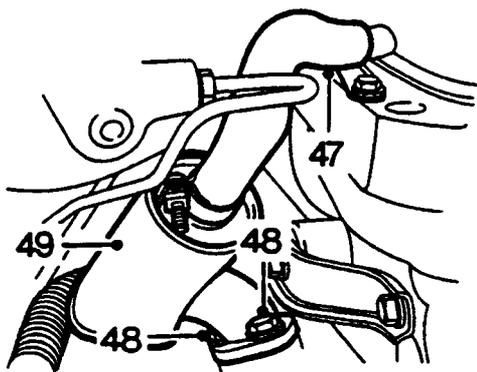

12M0152A

All models

- 47. Disconnect breather hose from pipe on cylinder head.
- 48. Remove 2 bolts securing breather separator to flywheel housing.
- 49. Remove breather separator and gasket.

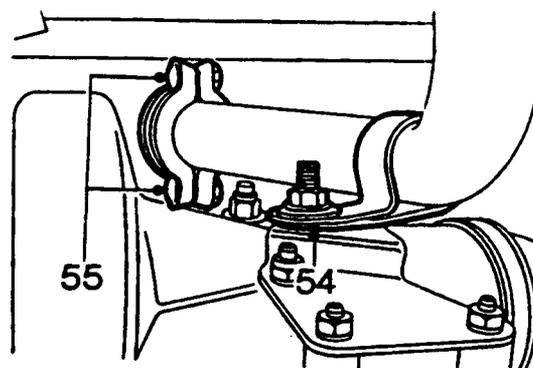
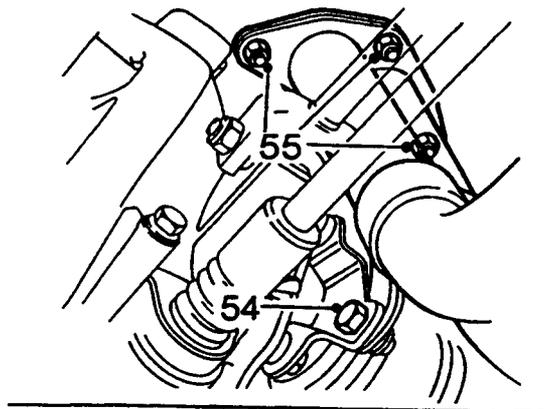

12M0960

- 54. Remove bolt securing exhaust front pipe to bracket on gearbox.
- 55. *SPi models:* Remove 3 nuts securing exhaust front pipe to manifold.
Carburettor models: Remove 2 bolts securing exhaust front pipe clamp to manifold.
- 56. Release exhaust front pipe from manifold, (remove gasket SPi models only).

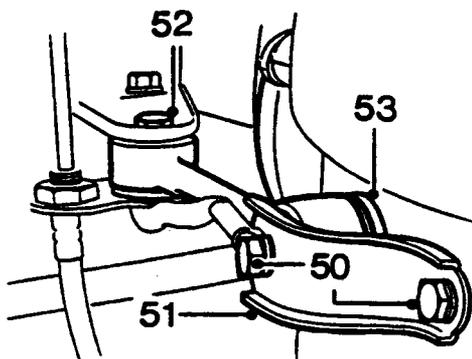

12M0153A

- 50. Remove 2 bolts securing steady bar to engine.
- 51. Remove steady bar bracket.
- 52. Slacken bolt securing steady bar to body and move steady bar aside.
- 53. Remove washer from steady bar.

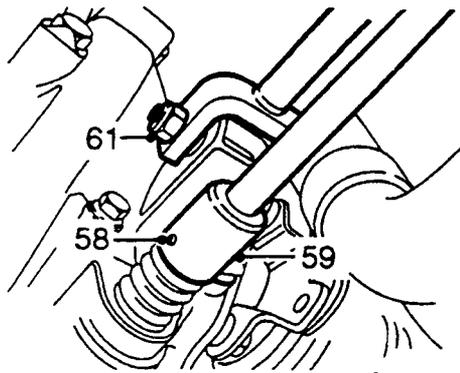

12M0155A

Manual gearbox models

57. Select reverse gear.
58. Remove roll pin securing gear change rod to gearbox.
59. Disconnect gear change rod from gearbox.
60. Select neutral in gearbox.
61. Remove bolt securing gear selector steady rod to gearbox.

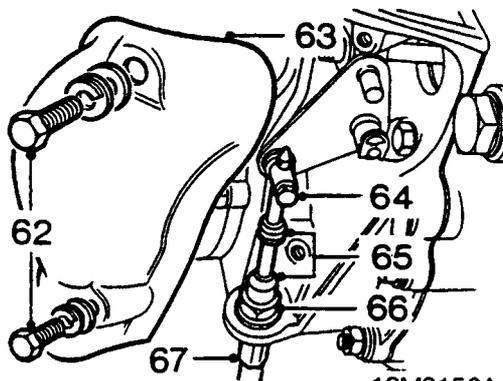

12M0156A

Automatic gearbox models

62. Remove 2 bolts securing gear selector cable cover to gearbox case.
63. Remove cover.
64. Slacken screw securing selector cable to bellcrank.
65. Release sleeves from selector cable.
66. Unscrew nut securing outer cable to gearbox case.
67. Release selector cable from gearbox case and bellcrank.
68. Remove rubber sleeves.

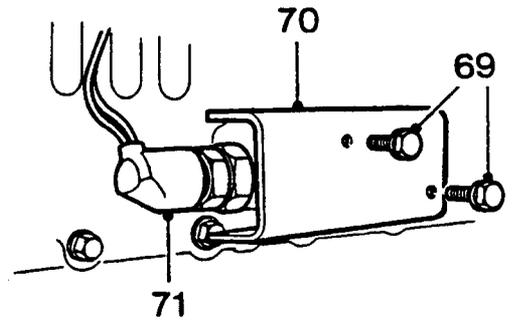

12M0157A

69. Remove 2 bolts securing inhibitor switch cover to gearbox.
70. Remove inhibitor switch cover.
71. Disconnect multiplug from inhibitor switch.

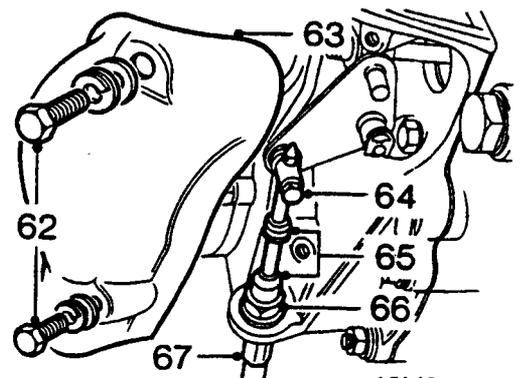

12M0158A

All models

72. Remove bolt securing lower steady bar to gearbox bracket.
73. Remove steady bar washers.
74. Drain engine oil, see **MAINTENANCE**.
75. Fit drain plug and new washer, tighten to 38 Nm.
76. Drain cooling system, see **MAINTENANCE**.

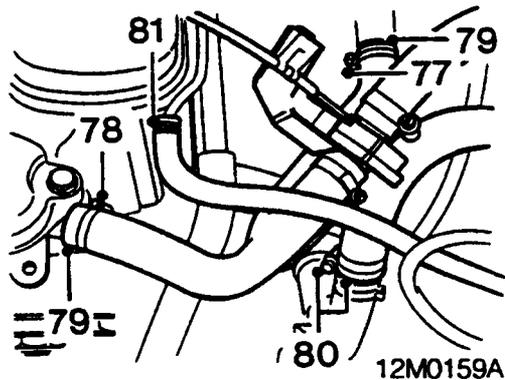

77. Slacken clip securing heater hose to manifold, (SPi models only).
78. Slacken clip securing heater hose to thermostat housing.
79. Release hoses.
80. Slacken clip and disconnect heater hose from radiator bottom hose.
81. Release clip and disconnect purge valve hose from pipe.
82. Remove front grille, see **BODY**.

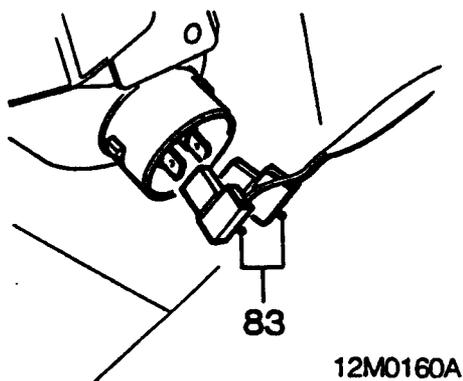

83. Disconnect 2 Lucars from radiator thermostatic switch.

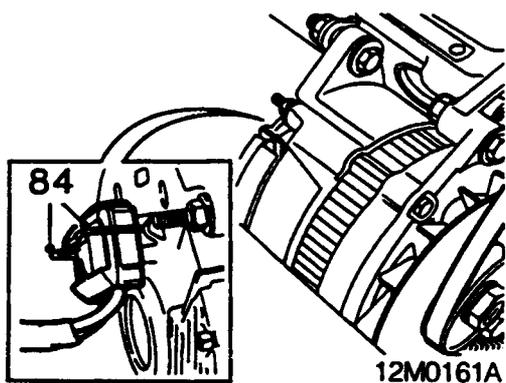

84. Release clip and disconnect multiplug from alternator.

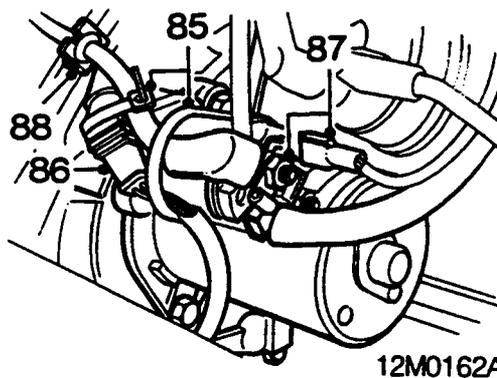

SPi models

85. Remove cable tie securing starter and crankshaft sensor cables to starter solenoid.
86. Disconnect multiplug from crankshaft sensor.

All models

87. Disconnect cables from starter solenoid.
88. Release starter cable grommet from bracket and move aside.

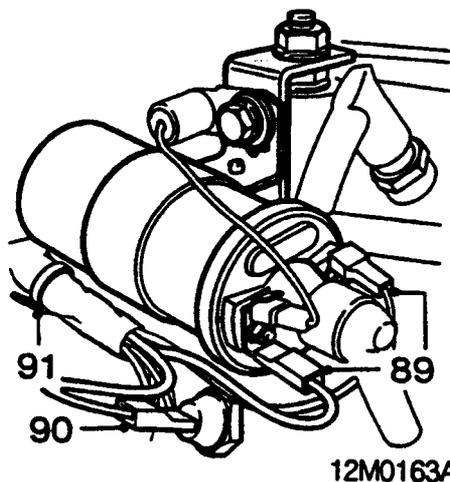

89. Disconnect 2 Lucars from ignition coil.
90. Disconnect Lucar from oil pressure switch.
91. Release engine harness from clutch housing and move aside.

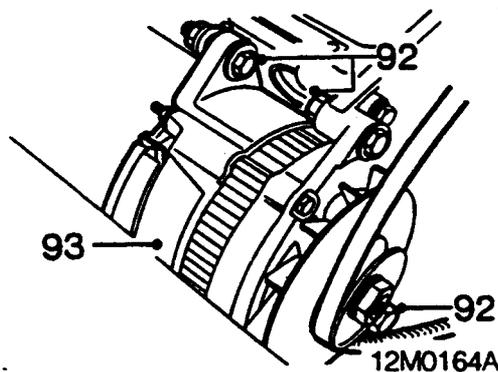

92. Remove 2 alternator mounting bolts and adjusting link nut.
93. Remove alternator.

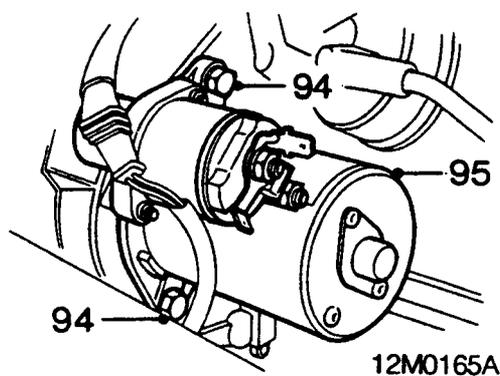

94. Remove 2 bolts securing starter motor to flywheel housing.
95. Remove starter motor and solenoid.

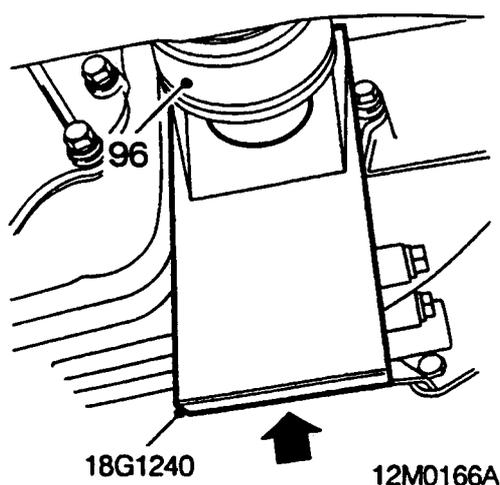

96. Using tool 18G 1240 release drive shafts from differential housing.
97. Remove front road wheels.
98. Raise one side of front suspension, using a jack under lower suspension arm.

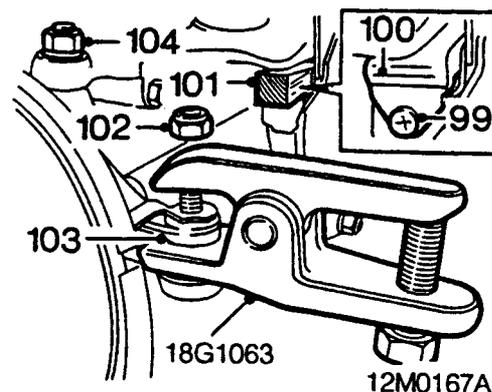

99. Remove screw securing rebound rubber to sub - frame.
100. Remove rebound rubber.
101. Fit wedge in place of rebound rubber and lower suspension onto wedge.
102. Remove nut securing track rod end to steering lever.
103. Break taper joint using tool 18G 1063.
104. Remove nut securing upper ball joint to suspension arm.
105. Use tool 18G 1063 to release suspension arm from front hub.
106. Support hub on stand.
107. Repeat procedure to release suspension arm from front hub on other side.
108. Withdraw drive shafts from differential housing.
109. Fit lifting equipment to engine and take weight of unit.

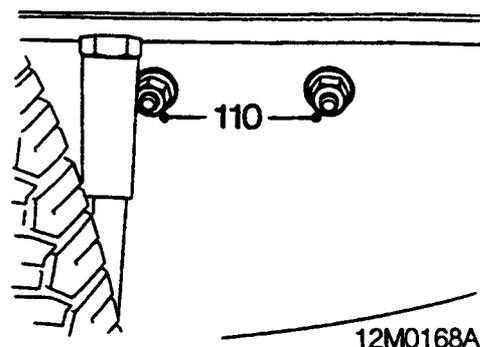

110. Remove engine mounting nuts and bolts and raise engine slightly.

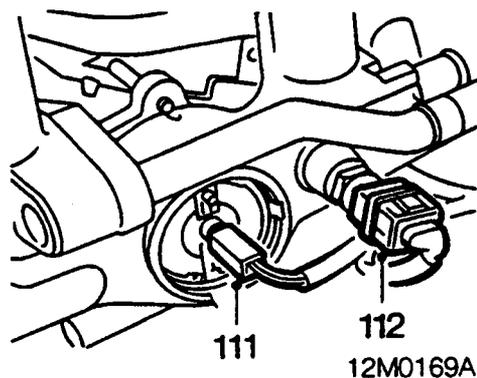

111
112
12M0169A

SPi models

- 111. Disconnect Lucar from manifold heater.
- 112. Disconnect multiplug from coolant sensor.

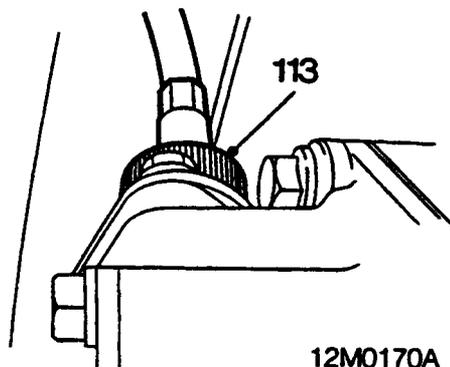

113
12M0170A

All models

- 113. Disconnect speedometer cable from gearbox.
- 114. Lift and manoeuvre engine and gearbox from vehicle.

Refit

1. Lower and manoeuvre engine and gearbox into position above mountings.
2. Connect speedometer cable to gearbox.

SPi models

3. Connect multiplug to coolant sensor.
4. Connect Lucar to manifold heater.

All models

5. Lower engine and align to engine mountings.
6. Fit engine mounting nuts and bolts and tighten to 22 Nm.
7. Release weight and remove lifting equipment.
8. Clean and lubricate drive shaft oil seal faces, and fit to gearbox.
9. Clean upper ball joint taper, fit to upper suspension arm and tighten nut to 52 Nm.
10. Clean taper, fit track rod end to steering lever, fit new nut and tighten to 30 Nm.
11. Using a jack under the lower arm, raise the suspension.
12. Remove wedge, fit rebound buffer, fit and tighten screw.
13. Lower the jack.
14. Repeat operations above to assemble the opposite side of front suspension.
15. Fit front wheels.
16. Fit starter motor and tighten bolts to 37 Nm.
17. Fit harness to clip on clutch housing.
18. Connect Lucar to oil pressure switch.
19. Connect leads to starter solenoid.
20. Fit starter lead grommet to bracket.
21. Connect multiplug to crankshaft sensor.
22. Secure starter leads and crankshaft sensor lead to solenoid with cable tie.
23. Connect Lucars to ignition coil.
24. Fit alternator and adjust drive belt tension, see **MAINTENANCE**.
25. Connect multiplug to alternator and secure clip.
26. Connect Lucars to thermostatic switch.
27. Fit front grille, see **BODY**.
28. Connect purge valve hose and secure clip.
29. Connect heater hose to radiator bottom hose and tighten clip.
30. Connect radiator bottom hose and tighten clip.
31. Connect heater hose to manifold and thermostat housing and tighten clips.
32. Align engine lower tie rod, fit washers, fit and tighten bolt.

Manual gearbox models

33. Fit bolt and connect gear change steady rod to gearbox, tighten bolt to 18 Nm.
34. Select reverse in gearbox and gear lever.
35. Connect gear change rod and fit new roll pin.
36. Select neutral in gearbox.



Automatic gearbox models

37. Connect inhibitor switch plug, fit switch cover and tighten bolts.
38. Fit nut and rubber sleeves to selector cable.
39. Connect cable to selector bellcrank.
40. Tighten nut, outer cable to gearbox case.
41. Select 'P' position at selector lever and at gearbox.
42. Adjust gear selector cable, see **AUTOMATIC GEARBOX.**
43. Position rubber sleeves over inner and outer cables.
44. Fit selector cable cover.
45. Fit and tighten cover bolts.

All models

46. Clean mating faces of exhaust front pipe and manifold, connect front pipe to manifold.
47. Fit bolt securing exhaust front pipe clip to gearbox bracket and tighten to 22 Nm.
48. Fit washer to engine end of tie rod and swing tie rod into position. Fit bolt securing tie rod bracket and earth lead, tighten bracket bolts to 22 Nm.
49. Tighten bolt securing tie rod to body to 22 Nm.
50. Clean mating faces of breather separator and flywheel housing. Fit bolts to separator fit new gasket, tighten bolts to 18 Nm.
51. Connect breather hose to pipe on cylinder head.

SPi models

52. Clean mating faces and fit throttle body spacer.
53. Position throttle body and connect breather hose.
54. Connect purge hose and secure clip.
55. Fit throttle body and fuel pipe bracket to manifold studs.
56. Fit throttle body nuts and tighten to 10 Nm.
57. Fit fuel pipe clip and tighten screw.
58. Connect breather hose to throttle body.
59. Connect throttle inner cable to cam.
60. Secure throttle cable in abutment bracket.
61. Check/adjust throttle cable, see **MODULAR ENGINE MANAGEMENT SYSTEM - SPi**
62. Connect multiplug to throttle potentiometer.
63. Connect multiplug to oxygen sensor.
64. Secure oxygen sensor lead to engine harness with cable tie.

Carburetter models

65. Position carburetter and tighten securing nuts to 22 Nm
66. *Automatic gearbox models:* Connect down shift rod to throttle lever.
67. Connect throttle cable and tighten trunnion screw.
68. Secure throttle cable in abutment bracket.
69. Check/adjust throttle cable, see **CARBURETTER & IGNITION.**

70. Secure choke outer cable to abutment bracket.
71. Connect choke inner cable to cam and adjust, see **CARBURETTER & IGNITION.**

All models

72. Connect the fuel hose to the carburetter assembly, tighten clip.
73. Connect the engine breather hose.
74. Connect the fuel return hose to the carburetter assembly, tighten clip.
75. Connect the vacuum advance pipe.
76. Position washers on each side of servo banjo union, fit and tighten banjo bolt to 50 Nm.
77. Connect vacuum pipes to the thermal vacuum switch.

All models

78. Fit clutch slave cylinder, fit and tighten bolts.
79. Fit fresh air intake duct and connect fresh air intake hose.
80. Fit horn, and tighten nuts.
81. Connect Lucar to horn.
82. Fit brake servo.
83. Remove plugs from pressure reducing valve and fit brake master cylinder, bleed brakes, see **BRAKES.**
84. *SPi models:* Connect multiplugs and vacuum pipe to ECU, fit ECU to valance and tighten screws.
85. Fit air cleaner.
86. Fit coolant expansion hose.
87. Fit splash shield and secure fasteners.
88. Fit bonnet, see **BODY.**
89. Remove stand(s) and lower vehicle.
90. Fill cooling system, see **MAINTENANCE.**
91. Fill engine with correct quantity and grade of oil, see **INFORMATION - CAPACITIES, FLUIDS AND LUBRICANTS.**
92. Connect battery earth lead.
93. Tighten road wheel nuts to 60 Nm.

CYLINDER HEAD

Service Repair No. 12.29.02

Remove

1. Disconnect battery earth lead.
2. Raise front of vehicle.

WARNING: Support on safety stands.

3. Remove bonnet, see **BODY**.
4. Release fasteners and remove splash shield.
5. Remove air cleaner:

SPi models, see MODULAR ENGINE MANAGEMENT SYSTEM.

Carburettor models, see CARBURETTER & IGNITION.

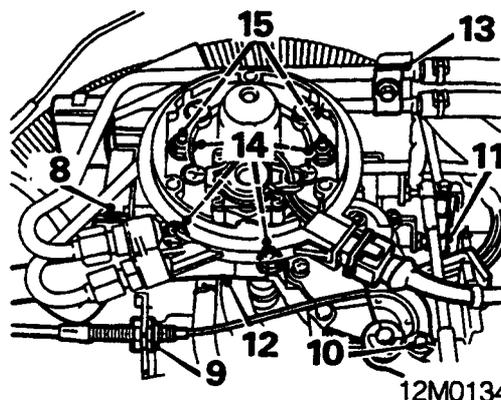

12M0134

SPi models

8. Disconnect multiplug from throttle potentiometer.
9. Release throttle cable from abutment bracket.
10. Disconnect throttle inner cable from cam.
11. *Automatic gearbox models:* Disconnect down shift rod from throttle lever.
12. Disconnect breather hose from throttle body.
13. Remove screw from fuel pipe clip and remove clip.
14. Remove 4 nuts securing throttle body.
15. Lift fuel pipe bracket from manifold studs.

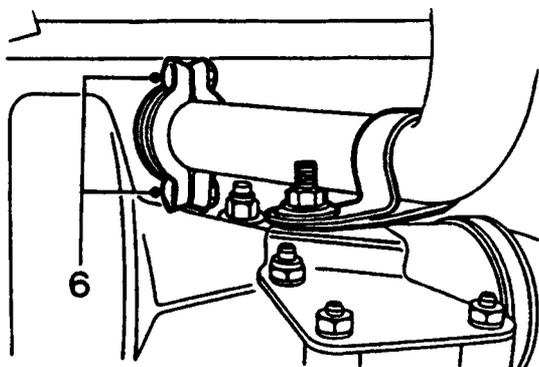
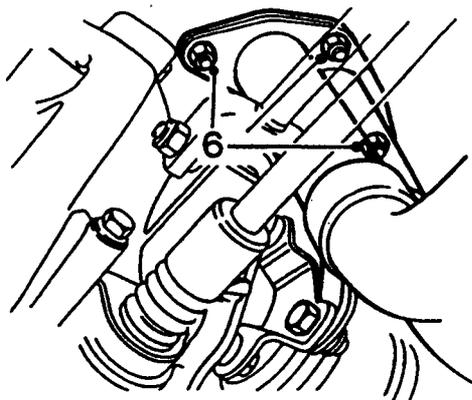

12M0961

6. *SPi models:* Remove 3 nuts securing exhaust front pipe to manifold
Carburettor models: Remove 2 bolts securing exhaust front pipe clamp to manifold.
7. Release exhaust front pipe from manifold, (and remove gasket SPi only).

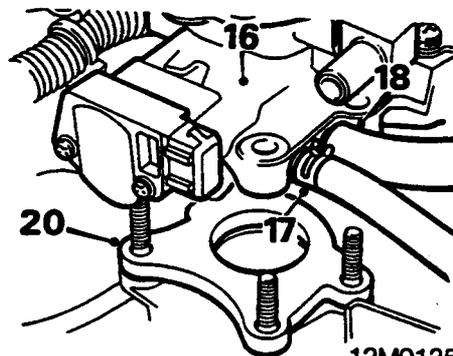

12M0135

16. Lift throttle body from manifold studs.
17. Release clip and disconnect purge hose from pipe.
18. Disconnect breather hose from pipe.
19. Move throttle body aside.
20. Remove throttle body spacer from studs.
21. Position drain tin under engine.

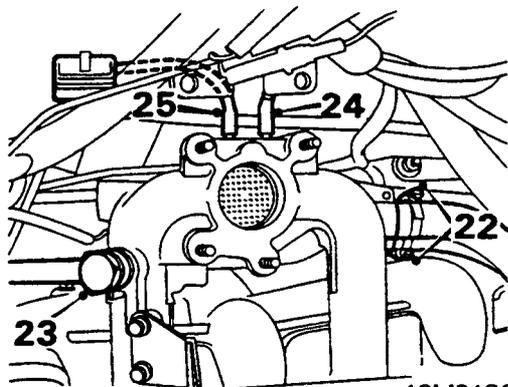

12M0136

22. Slacken 2 hose clips and disconnect coolant hoses from manifold and manifold pipe.
23. Remove servo banjo bolt from manifold and collect 2 washers.
24. Disconnect red vacuum pipe from manifold.
25. Disconnect black vacuum pipe from manifold.

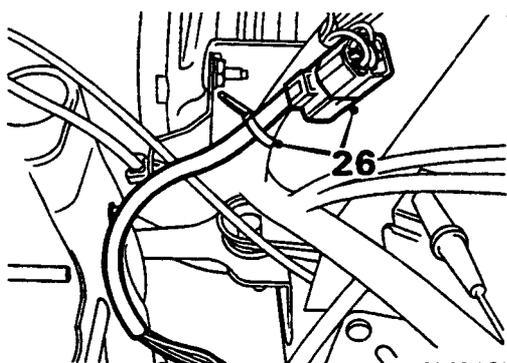

12M0137

26. Remove the cable tie securing oxygen sensor harness and disconnect the multiplug from the oxygen sensor.

Carburettor models

27. Remove carburettor, see **CARBURETTOR & IGNITION**.

All models

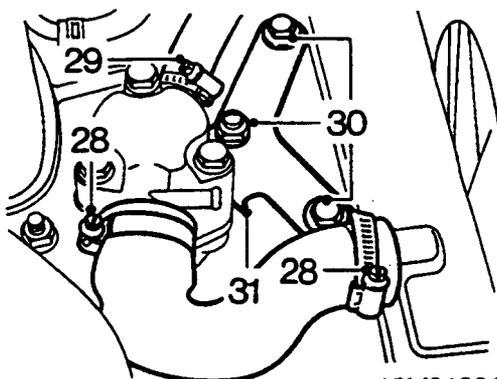

12M0138A

28. Slacken 2 clips and remove radiator top hose.
29. Slacken clip and disconnect heater hose from thermostat housing.
30. Remove 2 bolts and 1 nut securing radiator top bracket.
31. Remove bracket.

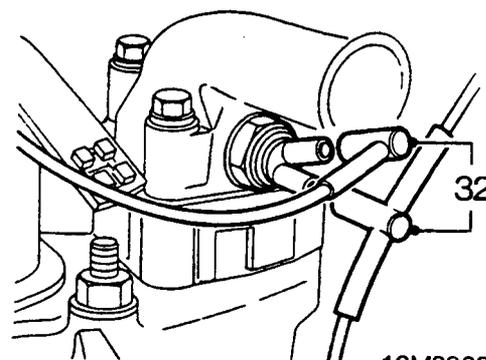

12M0962

32. *Carburettor models:* Noting their fitted positions disconnect vacuum pipes from the thermal vacuum switch.

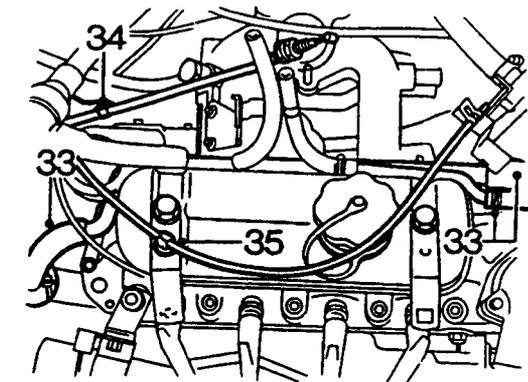

12M0963

SPi models

33. Disconnect 3 breather hoses from pipe.
34. Release throttle cable from clip.
35. Release heater cable from clip.

Carburettor models

36. Disconnect engine breather hose.
37. Release heater cable from clip.
38. Remove servo banjo bolt from inlet manifold and collect 2 washers.
39. Remove rocker shaft assembly, see **Rocker shaft assembly**.

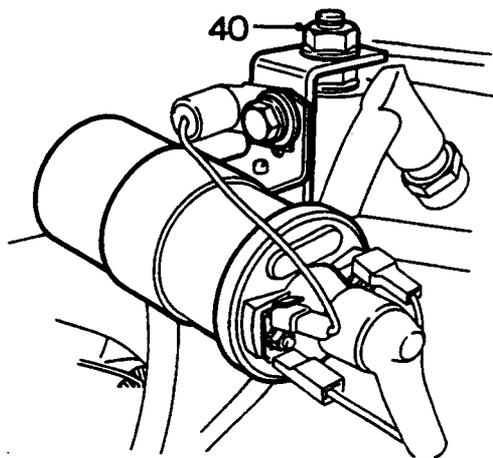

12M0140A

40. Remove cylinder head nut securing ignition coil, move coil aside.

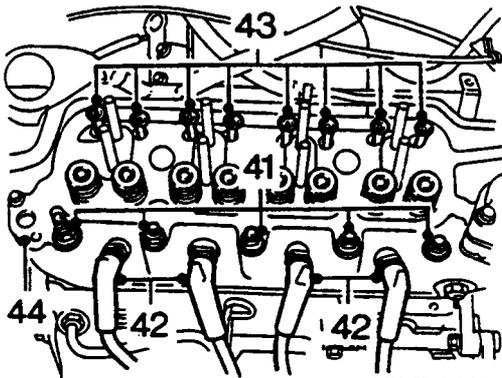

12M0141A

41. Remove 5 remaining cylinder head nuts.
 42. Disconnect leads from spark plugs.
 43. Remove push rods and retain them in original order.
 44. Raise cylinder head.

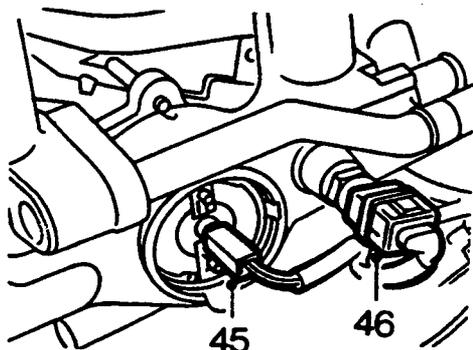

12M0142A

SPi models

45. Disconnect lead from manifold heater.
 46. Disconnect multiplug from manifold heater switch.

All models

47. Remove cylinder head assembly.
 48. Remove and discard cylinder head gasket.

Overhaul

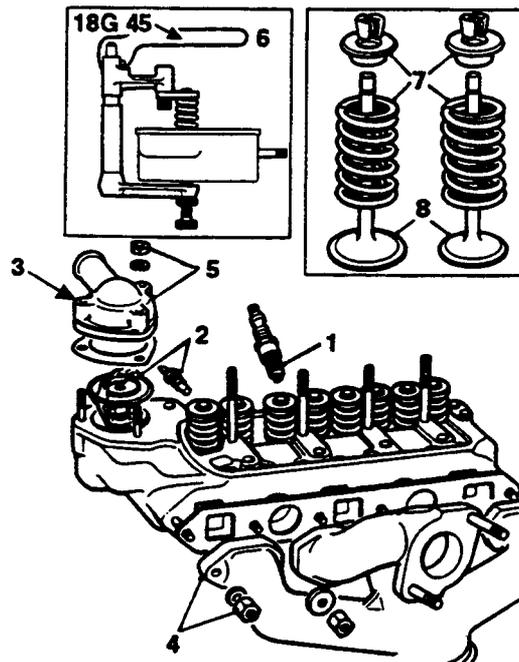

12M0964

1. Remove the spark plugs.
2. Remove the temperature sensor.
3. *Carburettor models:* Remove the thermal vacuum switch.
4. Remove 6 nuts securing the manifolds, remove manifolds.
5. Remove three nuts securing the thermostat housing, remove thermostat housing and thermostat.
6. Use tool 18G45 to compress the valve springs.
7. Remove the cotters, spring cup and spring.
8. Remove the valves, keep them in their fitted order.
9. Decarbonize the cylinder head and valves, taking care not to damage the valve seats and faces.

Cylinder head inspection/re - facing

Check cylinder head face for distortion with straight edge and feeler gauge, taking measurements across the length, width and diagonally.

Maximum permissible distortion = 0.076 mm.

Note: The cylinder head may be refaced up to the following dimensions:

Cylinder head height new = 2.750 mm.

Service limit = 2.735 mm.

Check brass coolant passage restrictors in the cylinder head face for security and correct flush fitted position.

Check valve seats and combustion chambers for cracks.



Valves/valve guides

Check each valve stem for undue wear, renew as necessary.

Insert each valve into its respective guide and check by hand the stem to guide clearance; if the head of the valve can be rocked excessively renew the guides.

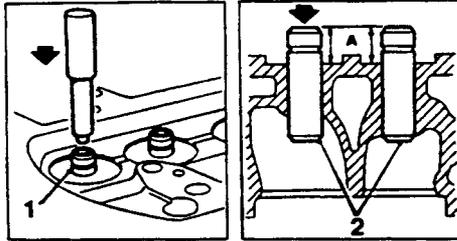

12M0966

1. Press out worn guides downwards into the ports (in the direction of the arrow).
2. Press in new valve guides from the top of the cylinder head until the top of the guide is above the machined face of the valve spring seating 'A'.
A = 13.72 mm.

Valve seat inspection/re - facing

Check each valve face for damage, severe pitting or burning and renew valves which cannot be satisfactorily refaced. Check each valve stem for wear and scoring.

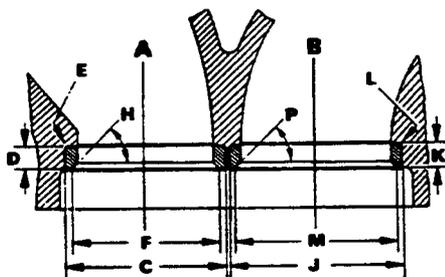

12M0965

EXHAUST (A)

- C = 31.252 to 31.290 mm.
- D = 4.72 to 4.77 mm.
- E = 0.38 mm. (max. radius)
- F = 28.00 mm.
- H = 45°

INLET (B)

- J = 36.487 to 36.512 mm.
- K = 4.72 to 4.77 mm.
- L = 0.38 mm. (max. radius)
- M = 38.481 to 38.354 mm.
- P = 45°

1. Using tools **18G27**, **18G167A**, **18G167D** remove the inlet and exhaust seat glazing.
2. Re - cut the inlet and exhaust valve seats, removing the minimum amount of metal necessary to correct the seat.
3. Using tools **18G27**, **18G167B**, **18G167C**, **18G167D** narrow the inlet and exhaust valve seats.
4. Using tool **18G29** lap the valves to the seats with fine grade paste.
5. Thoroughly wash and clean cylinder head prior to reassembling.

If the valve seats cannot be restored seat inserts can be used.

Valve seat inserts

1. Machine the cylinder head to accept the new inserts.
2. Press in the inserts.
3. Cut the seat inserts to the dimensions given in **Valve seat inspection/re - facing**. Ensure that the throats of the inserts blend to those of the cylinder head.

Reassembling

1. Lubricate valve stems with clean engine oil and refit valves to cylinder head in original order.
2. Lubricate and fit new valve stem oil seals.
3. Use tool **18G45** to refit the valves, spring cups valve springs and cotters.
4. Refit the thermostat and thermostat housing with new gasket.
5. Tighten thermostat housing nuts to 11 Nm.
6. Fit new gasket and exhaust manifold.
7. Tighten exhaust manifold nuts to 19 Nm.
8. Tighten the temperature sensor to 22 Nm.
9. *Carburettor models:* Refit the thermal vacuum switch.
10. Refit the spark plugs.

Refit

1. Clean cylinder head and block mating faces, ensure rocker oil feed drilling is clear. Clean mating faces of exhaust manifold and front pipe.
2. Fit new cylinder head gasket dry, ensuring that 'TOP' and 'FRONT' marks are correctly positioned, and all the studs are tight in the block face.
3. Position cylinder head on studs but do not lower fully.

SPi models

4. Connect manifold heater lead.
5. Connect manifold heater switch multiplug.

All models

6. Lower cylinder head.
7. Clean and lubricate push rods and fit them in original positions.
8. Fit rocker shaft assembly.
9. Lightly oil cylinder head stud threads and fit nuts finger tight.

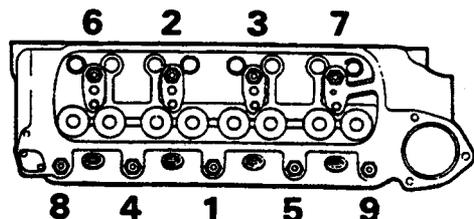

12M0143

10. Tighten cylinder head nuts progressively in order shown to 34 Nm initially. Finally tighten in order shown to 68 Nm.
11. Tighten rocker shaft bracket nuts to 32 Nm.
12. Adjust valve rocker clearance, see **MAINTENANCE**.
13. Fit rocker cover, with new gasket.
14. Fit ignition coil into position, fit and tighten nut.
15. Connect spark plug leads.
16. Fit hoses to breather pipe.
17. Fit throttle cable to clip.
18. Fit radiator top bracket and tighten bolts to 18 Nm.
19. Connect heater hose to thermostat housing and tighten clip.
20. Fit top hose to radiator and thermostat housing, tighten clips.

SPi models

21. Connect multiplug to oxygen sensor and secure harness with cable tie.
22. Connect black vacuum pipe to manifold.
23. Connect red vacuum pipe.
24. Position washers on each side of servo banjo union, fit and tighten banjo bolt to 50 Nm.
25. Connect coolant hoses to manifold and pipe, tighten hose clips.

26. Clean mating faces and fit throttle body spacer.
27. Position throttle body and connect breather hose.
28. Connect purge hose and secure clip.
29. Fit throttle body and fuel pipe bracket to manifold studs.
30. Fit nuts securing throttle body and tighten to 10 Nm.
31. Fit fuel pipe clip and tighten screw.
32. Connect breather hose to throttle body.
33. *Automatic gearbox models:* Connect down shift rod to throttle lever.
34. Connect throttle inner cable to cam.
35. Secure throttle cable in abutment bracket.
36. Check/adjust throttle cable, see **MODULAR ENGINE MANAGEMENT SYSTEM**.
37. Connect multiplug to throttle potentiometer.

Carburettor models

38. *Automatic gearbox models:* Connect down shift rod to throttle lever.
39. Connect throttle inner cable to cam.
40. Secure throttle cable in abutment bracket.
41. Check/adjust throttle cable, see **CARBURETTER & IGNITION**.
42. Secure choke outer cable to abutment bracket.
43. Connect choke inner cable to cam and adjust, see **CARBURETTER & IGNITION**.
44. Connect the fuel hose to the carburettor assembly, tighten clip.
45. Connect the engine breather hose.
46. Connect the fuel return hose to the carburettor assembly, tighten clip.
47. Connect the vacuum advance pipe.
48. Position washers on each side of servo banjo union, tighten banjo bolt to 50 Nm.
49. Position carburettor with new gaskets and tighten securing nuts to 22 Nm.
50. Connect vacuum pipes to the thermal vacuum switch.

All models

51. Connect exhaust front pipe, with gasket (SPi models only) to manifold and tighten nuts.
52. Refit air cleaner, *SPi models, see MODULAR ENGINE MANAGEMENT SYSTEM. Carburettor models, see CARBURETTER & IGNITION.*
53. Fit splash shield.
54. Fit bonnet, see **BODY**.
55. Remove drain tin.
56. Remove stand(s) and lower vehicle.
57. Fill cooling system, see **MAINTENANCE**.
58. Connect battery earth lead.



CRANKSHAFT

Service Repair No. 12.21.33.

Remove

1. Remove the engine and gearbox assembly, see **Engine and gearbox**.
2. Separate the gearbox assembly from the engine block:
Manual models, see MANUAL GEARBOX.
Automatic models, see AUTOMATIC GEARBOX.
3. Remove the timing chain and gears, see **Timing chain and gears**.

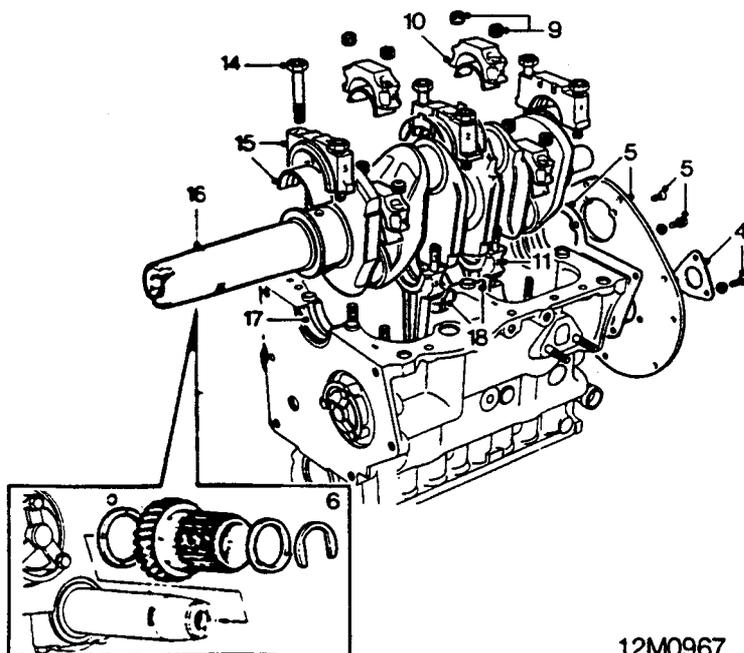

12M0967

4. Remove 3 screws securing the camshaft locating plate, remove plate.
5. Remove the screws securing the cylinder block front plate, remove plate and gasket.
6. Remove the crankshaft primary gear thrust washer and backing ring, pull off the primary gear and thrust washer.
7. Check the identification marks on the connecting rods and big - end bearing caps.
8. If they are not marked, mark each rod and cap in sequence '1' to '4' on the camshaft side.
9. Remove 2 nuts securing each big - end cap.
10. Withdraw the big - end caps and bottom half bearing shells.
11. Push the piston and connecting rod assemblies upwards to release the rods from the crankshaft.
12. Check the identification marks on the main bearing caps.
13. Remove 2 bolts securing each main bearing cap.
14. Remove the main bearing caps.
15. Lift out the crankshaft.
16. Release the main bearing shells from the block and store them with their respective caps.
17. Remove the crankshaft thrust washers from the block.

Note: Retain each shell with its respective cap.

ENGINE

Overhaul

1. Check condition of oil pump, renew if necessary.
2. Check crankshaft condition and wear.
Main journal diameter = 50.83 to 50.84 mm.
Min. regrind diameter = 49.78 mm.
Crankpin journal diameter = 44.44 to 44.46 mm.
Min. regrind diameter = 43.44 mm.
3. Renew or regrind if necessary.
4. Renew the main and big - end bearings as necessary.

Main Bearing selection

CYLINDER BLOCK CODE	RED	RED	RED	GREEN	GREEN	GREEN	YELLOW	YELLOW	YELLOW
CRANKSHAFT CODE	RED	GREEN	YELLOW	RED	GREEN	YELLOW	RED	GREEN	YELLOW
UPPER BEARINGS (CYLINDER BLOCK BORE)	RED	RED	GREEN	GREEN	GREEN	GREEN	GREEN	YELLOW	YELLOW
LOWER BEARING (BEARING CAP)	RED	GREEN	GREEN	RED	GREEN	YELLOW	GREEN	GREEN	YELLOW

All current engines employ graded main bearings, which are colour coded Red, Green and Yellow. These grades are identified by the colours marked on the main bearing caps (for main bearing cap housing size), and on the crankshaft webs adjacent to each to each main bearing journal.

Note:

- All three colour codes are used in engine manufacture only. Crankshafts supplied in service are all colour coded GREEN
- If colour code main bearings are being fitted with a colour coded cylinder block and crankshaft, the type of bearing used must be accordance with the bearing chart.
- If bearings are being fitted to a non - colour coded cylinder block, fit GREEN coded bearings and carry out the following clearance check using plastigauge.



Clearance check

1. Place the grooved halves of the bearing into the cylinder block and the plain halves in the main bearing caps.

Note: Do not lubricate.

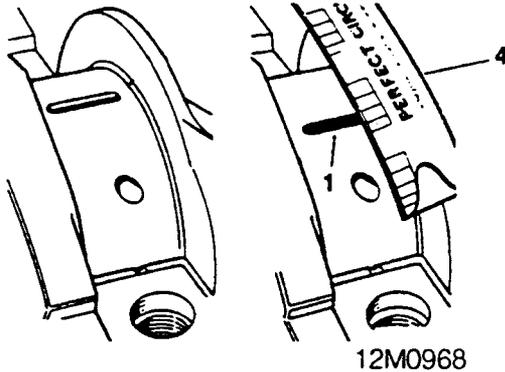

2. Place the crankshaft in position and place a piece of plastigauge across each main bearing journal.
3. Fit the main bearing caps and tighten the bolts to 85 Nm.

CAUTION: Do not rotate crankshaft.

4. Remove the bearing caps and measure the width of the flattened plastigauge using the gauge card.
Clearance in main bearings = 0.017 to 0.058 mm.
5. Too much clearance fit RED colour coded bearings.
Insufficient clearance fit YELLOW colour coded bearings.

Refit

1. Thoroughly clean out all the crankshaft oilways.
2. Fit the top half of the main bearing shells into their respective locations in the cylinder block, lubricate with engine oil.
3. Place the crankshaft into the bearings.
4. Fit the thrust washers with the tab on the washer locating in the slot on the centre main bearing cap.

CAUTION: The thrust washer oilways must be facing the crankshaft and away from the bearing cap.

5. Ensure that the lower half bearing shells are correctly located in the caps, fit the caps.
6. Check the crankshaft end - float,
Crankshaft end - float = 0.051 to 0.076 mm.

Note: Replacement thrust washers must be only replaced in top/lower pairs.

7. Select thrust washers which will set the correct end - float figure.
Three sizes of thrust washer are available:
Standard.
0.076 mm - oversize.
0.76 mm - oversize.
8. Tighten the main bearing cap bolts to 85 Nm.
9. Fit the big - end shell bearings into the connecting rods and caps, lubricate the bearings.
10. Draw the connecting rods and pistons to the crankshaft.
11. Refit the big - end caps, noting the numerical marks placed on the camshaft side of the engine.
12. Tighten the big - end cap nuts to 45 Nm.
13. Ensure the crankshaft turns freely.
14. Using a new gasket, refit the cylinder block front plate.
15. Refit the camshaft locating plate.
16. Tighten the camshaft locating plate screws to 11 Nm.
17. Refit the timing chain and gears, see **Timing chain and gears**.
18. Refit the crankshaft primary gear rear thrust washer, backing ring, primary gear and front thrust washer,
check primary gear end - float, see **Adjustments**.
19. Refit the gearbox assembly to the engine block, *Manual models*,
see **MANUAL GEARBOX**.
Automatic models,
see **AUTOMATIC GEARBOX**.
20. Refit the engine and gearbox assembly, see **Engine and Gearbox**.

CONNECTING RODS AND PISTONS

Service Repair No. 12.17.01.

Remove

1. Remove the engine and gearbox assembly, see **Engine and gearbox**.
2. Separate the gearbox assembly from the engine block:
Manual models, see MANUAL GEARBOX.
Automatic models, see AUTOMATIC GEARBOX.
3. Remove the cylinder head, see **Cylinder head**.

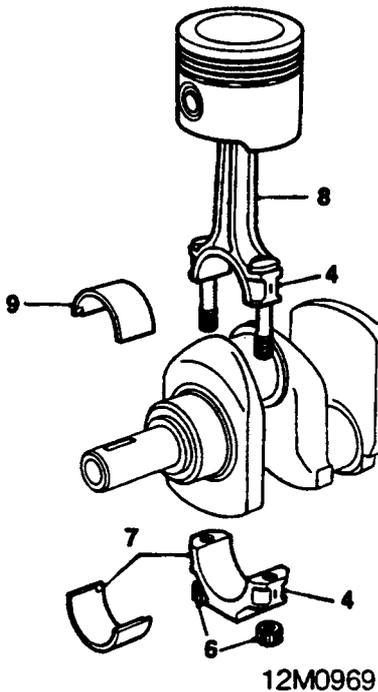

4. Check the identification marks on the connecting rods and big - end bearing caps.
5. If they are not marked, mark each rod and cap in sequence '1' to '4' on the camshaft side.
6. Remove 2 nuts securing each big - end cap.
7. Withdraw the big - end caps and bottom half bearing shells.

Note: Retain each shell with its respective cap.

8. Push the piston and connecting rod assemblies upwards and withdraw them from the top of the cylinder block.
9. Remove the top half bearing shells from the connecting rods if a new set is to be fitted, otherwise retain each shell with its respective connecting rod.



Overhaul

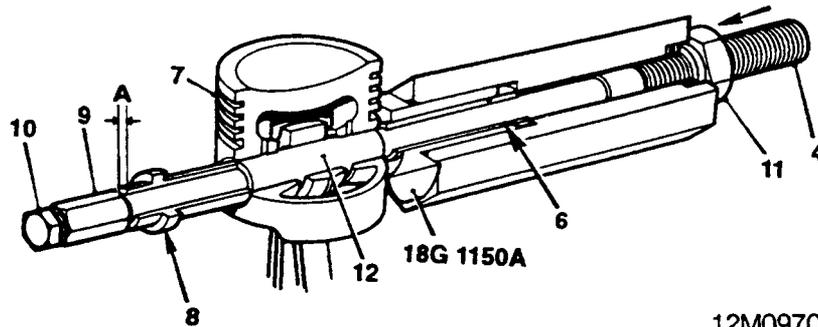

12M0970

Gudgeon pin remove

1. Remove piston rings.
2. Retain body of tool 18G1150 in vice.
3. Screw the nut back until it is flush with the end of the centre screw.
4. Push the screw forward until the nut contacts the thrust race.
5. Fit adapter 18G1150 A onto the centre screw.
6. Slide the sleeve onto the centre screw, groove end first.

Note: Smear the outside diameter with oil.

7. Fit piston to the centre screw.
8. Fit bush onto the centre screw, flanged end away from the gudgeon pin.
9. Screw the stop nut onto the centre screw, adjust until 0.8 mm. end - play 'A' exists.
10. Tighten the lock screw.

Note: Check that the bush and sleeve are correctly positioned on both sides of the piston.

11. Screw the nut up to the thrust race.
12. Hold the lock screw and turn the nut until the gudgeon pin is removed.

ENGINE

Gudgeon pin refit

1. Remove the nut and pull the centre screw out of the tool.

Note: Lubricate the threads of the nut and screw.

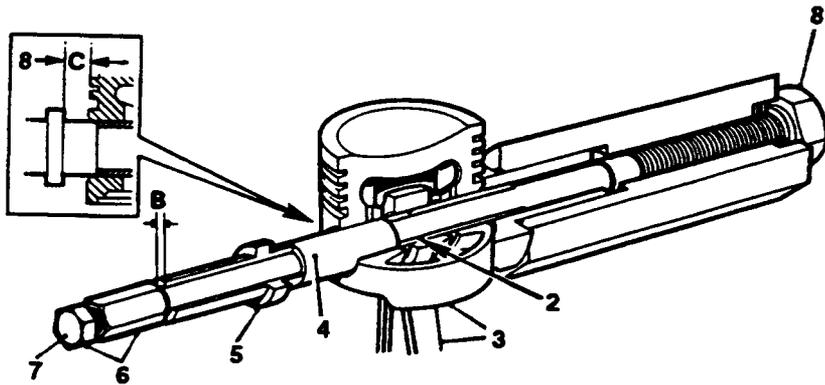

12M0971

2. Slide the sleeve onto the centre screw, groove end last.

Note: Lubricate the gudgeon pin and bore of the connecting rod with graphite oil.

3. Fit the connecting rod and piston to the tool.
4. Fit the gudgeon pin into the piston bore up to the connecting rod.
5. Fit bush onto the centre screw, flanged end towards the gudgeon pin.
6. Screw the stop nut onto the centre screw, adjust until 0.8 mm. end - play 'B' exists.
7. Tighten the lock screw.

Note: Check that the bush and sleeve are correctly positioned on both sides of the piston.

8. Tighten the nut to 22 Nm, pulling in the gudgeon pin until the flange of the bush is 0.8 mm 'C' away from the piston skirt.

CAUTION: The flange of the bush must NOT contact the piston.

9. Remove the tool.
10. Check the piston pivots and slides freely on the gudgeon pin.



Piston ring refit

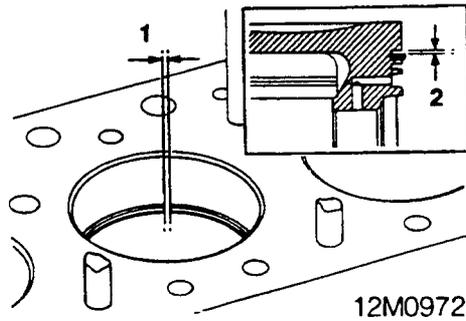

1. Insert each piston ring in turn squarely into its bore and check the ring gap:
Top = 0.25 to 0.45 mm.
Second = 0.20 to 0.33 mm.
Oil control = 0.38 to 1.04 mm.
2. Check the compression ring to groove clearance;
Compression ring to groove clearance = 0.38 to 0.89mm.

Oil control ring

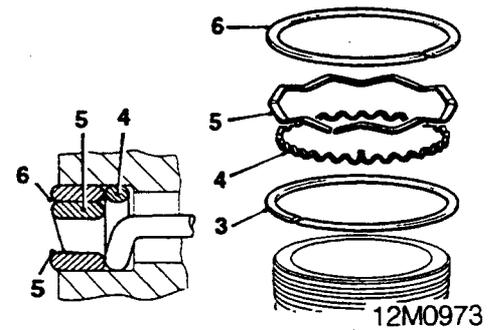

3. Fit the bottom rail to the piston and position it below the bottom groove.
 4. Fit the oil control expander to the bottom groove, and move the previously positioned rail up into the groove.
 5. Fit the side spring.
 6. Fit the top rail to the top of the bottom groove.
- Note:** Set the gaps of the rails and the expander not less than 90° apart on the non-thrust side of the piston.
7. Fit the second and top rings to the piston.
 8. Fit the compression ring with the face marked 'TOP' towards the top of the piston.

Note: Set the gaps of the top rings at 90° to each other on the non-thrust side of the piston.

Refit

1. Fit the bearing shells to the connecting rods and big - end caps.
2. Lubricate the pistons with graphite oil.

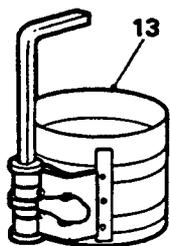

12M0974

3. Fit tool 18G55A over the piston assembly to compress the piston rings.
4. Refit each piston and connecting rod assembly to its original cylinder bore.

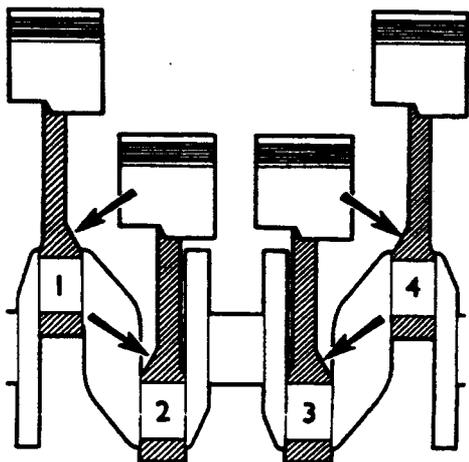

12M0975

5. Ensure the following;

- Nos. 1 and 3 connecting rods are offset towards the front of the engine.
 - Nos. 2 and 4 connecting rods are offset towards the rear of the engine.
6. Lubricate the bearings with clean engine oil.
 7. Refit the big - end caps noting the numerical marks.
 8. Tighten the big - end cap nuts to 45 Nm.
 9. Refit the cylinder head, see **Cylinder head**.
 10. Refit the gearbox assembly to the engine block:
Manual models, see MANUAL GEARBOX.
Automatic models, see AUTOMATIC GEARBOX.
 11. Refit the engine and gearbox assembly, see **Engine and gearbox**.

CAMSHAFT

Service Repair No. 12.13.02.

Remove

1. Remove the engine and gearbox assembly, see **Engine and gearbox**.
2. Remove the rocker shaft, see **Rocker shaft assembly**.
3. Withdraw the push rods and retain them in their installed order.
4. Remove the distributor drive shaft, see **Distributor drive shaft**.
5. Carburetter models: Remove the fuel pump, see **CARBURETTER & IGNITION**.
6. Remove the timing chain and gears, see **Timing chain and gears**.
7. Lay the engine assembly on its side to facilitate camshaft removal, and prevent the tappets falling into the gearbox when the camshaft is removed.

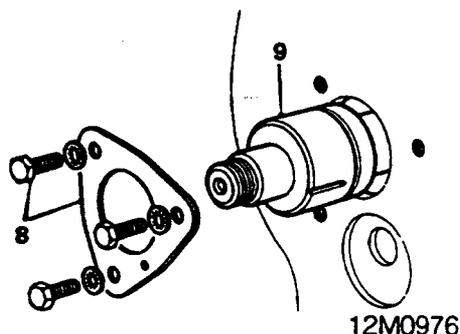

8. Remove three securing screws and lift off the camshaft locating plate.
9. Withdraw the camshaft.

Refit

1. Refit the camshaft. Ensure the oil pump drive engages the rear end of the camshaft.
2. Fit the locating plate and tighten securing screws to 11 Nm.
3. Refit the timing chain and gears, see **Timing chain and gears**.
4. Check the camshaft end - float.
End - float = 0.076 to 0.178 mm.
5. If the end - float is out of tolerance renew locating plate.
6. Refit the fuel pump, see **CARBURETTER & IGNITION**.
7. Refit the distributor drive shaft, see **Distributor drive shaft**.
8. Insert the push rods in their correct positions.
9. Refit the rocker shaft, see **Rocker shaft assembly**.
10. Refit the engine and gearbox assembly, see **Engine and gearbox**.



OIL PUMP

Overhaul

Service Repair No. 12.60.26.

Remove

Manual models

1. Remove the clutch assembly, see **CLUTCH**.
2. Remove the flywheel housing, see **Flywheel housing**.

Automatic models

3. Remove the torque converter and torque converter housing, see **AUTOMATIC GEARBOX**.
4. Withdraw the oil feed pipe.

All models

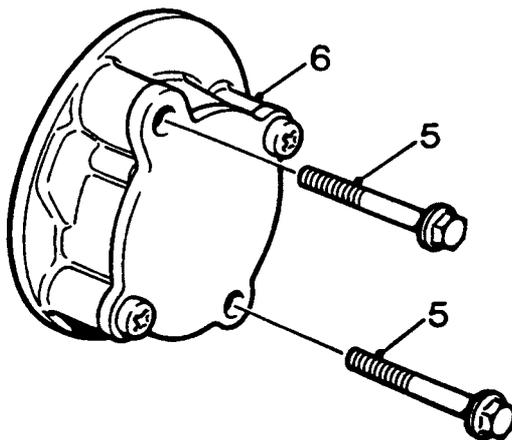

12M1080

5. Remove the oil pump retaining bolts.
6. Remove the oil pump.
7. Remove the gasket.

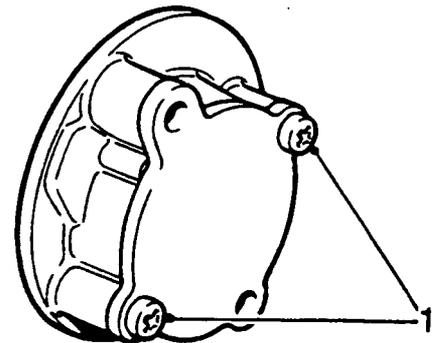

12M1083

1. Remove the pump cover retaining screws.
2. Remove the pump rotors.
3. Clean the pump components and fit the rotors to the pump body.

Note: Ensure the outer rotor is fitted with the chamfered edge downwards.

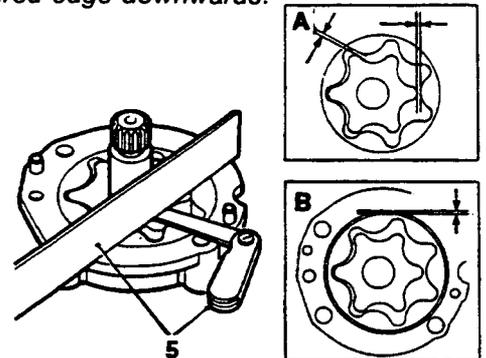

12M0979

4. Using a feeler gauge, check the rotor lobe clearance, outer rotor to body diametrical clearance, outer ring end - float and inner rotor end - float:
 - A - rotor lobe clearance = 0.152 mm;
 - B - outer rotor to body diametrical clearance = 0.254 mm;
 - Outer ring end - float = 0.127 mm;
 - Inner rotor end - float = 0.127 mm.
5. If any of these clearances are outside the limits given, or if there is damage to the components, renew the pump. If the clearances and component condition are satisfactory assemble the pump.

Refit

1. Fit a new gasket to the pump.

Note: Ensure that the cut - aways in the gasket and the holes in the oil pump are correctly aligned.

2. Prime the oil pump by filling with clean engine oil and turning the spindle until oil is seen moving through the pump.
3. Fit the pump to the engine, ensure the pump drive spindle is engaged with the camshaft.
4. Tighten bolts securing oil pump to block to 11 Nm.

Automatic models

5. Fit the oil feed pipe.
6. Refit the torque converter and torque converter housing.

Manual models

7. Refit the flywheel housing.
8. Refit the clutch assembly. see **CLUTCH**.

DISTRIBUTOR DRIVE SHAFT

Service Repair No. 12.10.22

Remove

1. Disconnect battery earth lead.
2. Remove distributor:
SPi models , see **MODULAR ENGINE MANAGEMENT SYSTEM**.
Carburetter models, see **CARBURETTER & IGNITION**.
3. Note the fitted angle of the drive shaft slot.
4. Screw a 5/16 in. UNF bolt, approx 90 mm long into the drive shaft.
5. Withdraw drive shaft, which will rotate approx. 90° clockwise during removal.
6. Remove bolt from drive shaft.

Refit

1. Ensure No. 1 piston is at TDC (compression).
2. Screw a 5/16 in UNF bolt, approx 90 mm long into the drive shaft.

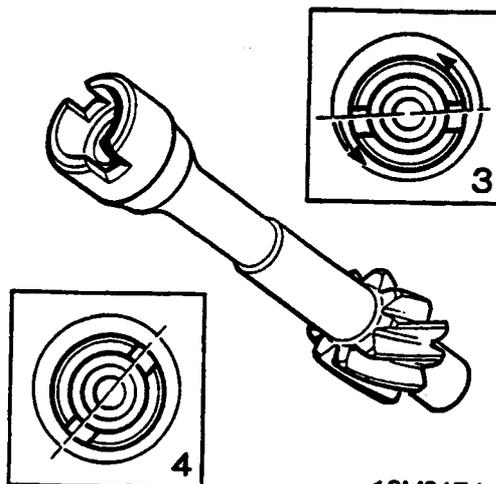

12M0174

3. Enter drive shaft into engine with driving slot in position shown with the large offset uppermost.
4. Push drive shaft into engagement with camshaft. Drive shaft will rotate anti - clockwise during engagement and final position must be with driving slot in position shown and large segment uppermost.
5. Remove bolt from driveshaft.
6. Refit distributor:
SPi models , see **MODULAR ENGINE MANAGEMENT SYSTEM**.
Carburetter models, see **CARBURETTER & IGNITION**.
7. Check/adjust ignition timing.
8. Connect battery earth lead.



FLYWHEEL HOUSING

Service Repair No. 12.53.01.

Remove

1. Remove the clutch and flywheel, see **CLUTCH**.
2. Drain the engine/gearbox oil, see **MAINTENANCE**.
3. Release the clutch slave cylinder from the flywheel housing and place to one side.

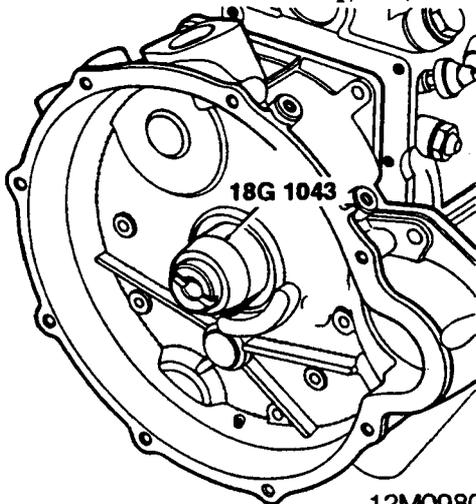

4. Position tool **18G1043** over the splines on the crankshaft primary gear.

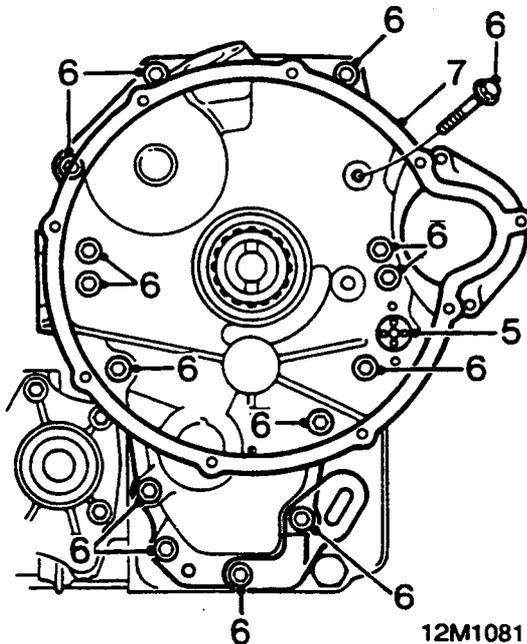

5. *SPi models*, remove the crankshaft sensor, see **MODULAR ENGINE MANAGEMENT SYSTEM**.
6. Remove the bolts securing the housing.
7. Remove the housing.

Note: The housing is also located to the gearbox by two dowels.

8. Remove all traces of the gasket from both faces.

9. Remove the primary gear oil seal from the housing, with a suitable drift.

Note: The oil seal can be removed and refitted without removing the flywheel housing, see **Flywheel housing oil seal**.

Refit

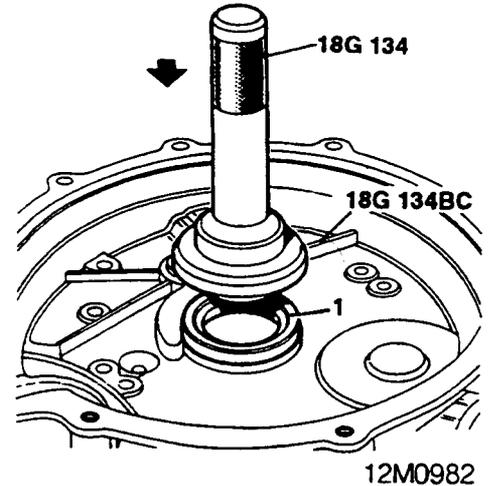

1. Lubricate new primary gear oil seal with engine oil.
2. Support the underside of the flywheel housing.
3. Using tools **18G134** and **18G134 BC**, drift the new seal into the housing.
4. Check and adjust the idler gear end – float if a new flywheel housing is being fitted, see **MANUAL GEARBOX**.
5. Fit a new gasket and ensure both locating dowels are correctly aligned.

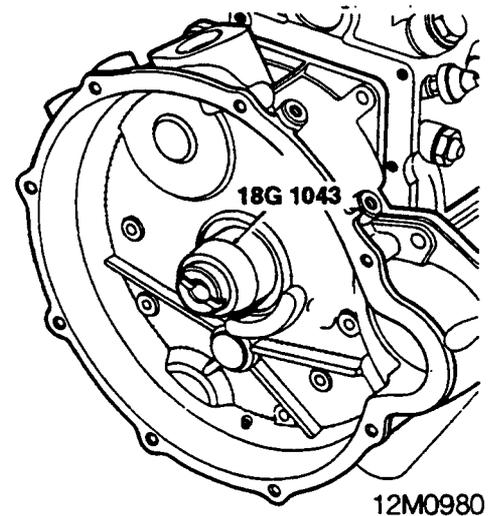

6. Ensure tools **18G1043** are located over the primary gear and screwed into the two lower holes of the cylinder block.
7. Refit the flywheel housing and remove the tools.
8. Apply Loctite 242 to the first three threads of the bolts and tighten to 25 Nm.

9. *SPi models*, refit the crankshaft sensor, see **MODULAR ENGINE MANAGEMENT SYSTEM**.
10. Engage the release lever push rod and refit the clutch slave cylinder.
11. Refit the clutch and flywheel, see **CLUTCH**.
12. Fill the engine/gearbox with oil, see **MAINTENANCE**.

FLYWHEEL HOUSING OIL SEAL

Service Repair No. 12.53.02.

Remove

1. Remove the clutch and flywheel, see **CLUTCH**.

CAUTION: *SPi models*, care must be taken not to damage the crankshaft sensor.

2. Remove the dust shield from the primary gear.
3. Remove the 'C' shaped thrust washer and backing ring securing the primary gear to the crankshaft.

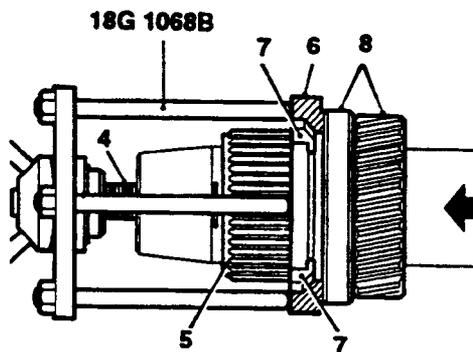

12M0984

4. Screw centre bolt of **18G1068 B** securely into the crankshaft.
5. Pull the primary gear outwards as far as possible by hand.
6. Screw the body of tool **18G1068 B** over the centre bolt until the groove in the primary gear is visible inside the tool body.
7. Fit two half collets of the tool into the groove in the gear.
8. Turn the winged nut anti-clockwise to withdraw the primary gear and oil seal clear of the housing.

Refit

1. Check and adjust the primary gear end - float, see **Adjustments**.
2. Fit tool **18G1043** over the primary gear.
3. Lubricate the new seal with engine oil and fit over the protective tool onto the primary gear.
4. Smear the primary gear thrust washer with oil and fit it with the chamfered inner edge against the crankshaft.
5. Locate the primary gear onto the crankshaft until the gear teeth are starting to engage with those of the idler gear.

CAUTION: Do not fully engage the mesh of the primary gear or the seal will become displaced.

6. Pass the body of tool **18G1068 B** over the crankshaft.
7. Screw the winged nut in a clockwise direction until the seal is pressed into the housing.

Note: The seal is correctly fitted when the base of the tool contacts the lip of the housing bore.

8. Remove the special tool.
9. Refit the 'C' shaped thrust washer and backing ring.
10. Refit the dust shield on the primary gear splines with its stepped face marked 'FLYWHEEL SIDE' facing away from the engine.
11. Refit the clutch and flywheel, see **CLUTCH**.



MAIN BEARING CAP OIL SEAL

Service Repair No. 12.21.38.

Remove

1. Remove the engine front plate, see **Crankshaft**.
2. Remove the seal from the front main bearing cap recess.

Refit

1. Thoroughly clean the front main bearing – cap recess and the front face of the engine block.
2. Coat the ends of the seal with RTV compound and lubricate the seal with engine oil.
3. Fit the seal into the main bearing – cap recess by first inserting the top edges and then working the seal into position until the face of the seal is flush with the cylinder block face.
4. Refit the engine front plate, see **Crankshaft**.

CRANKSHAFT PULLEY

Service Repair No. 12.21.01.

Remove

1. Disconnect battery earth lead.
2. Raise front of vehicle.

WARNING: Support on safety stands.

3. Release fasteners and remove splash shield.
4. Remove radiator, see **COOLING SYSTEM**.

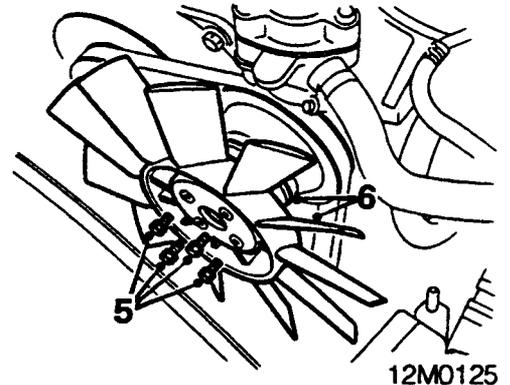

5. Remove bolts securing the cooling fan.
6. Remove fan and spacer.

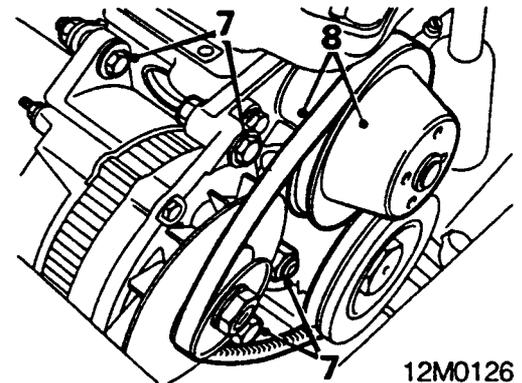

7. Slacken alternator mounting bolts and nut.
8. Remove alternator drive belt and coolant pump pulley.

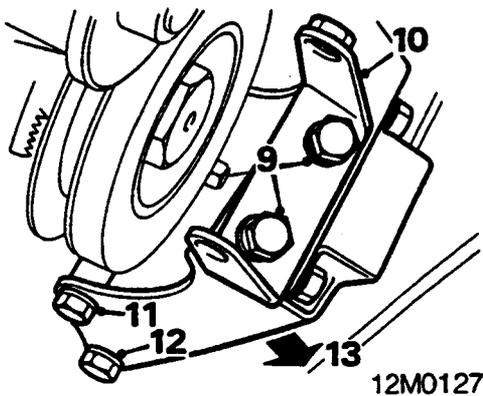

Manual gearbox models

9. Remove bolts securing the radiator lower mounting bracket to engine mounting bracket.
10. Remove radiator lower mounting bracket.
11. Remove top bolt securing the mounting bracket to gearbox.
12. Slacken bottom bolt securing the mounting bracket to gearbox.
13. Pivot bracket down for access to crankshaft pulley bolt.

Automatic gearbox models

14. Support power unit on jack.

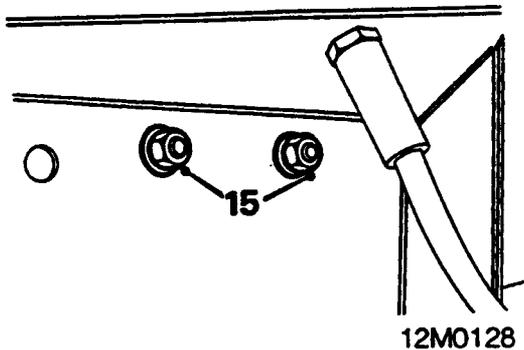

15. Remove nuts and bolts securing the engine LH mounting to subframe.
16. Raise power unit.

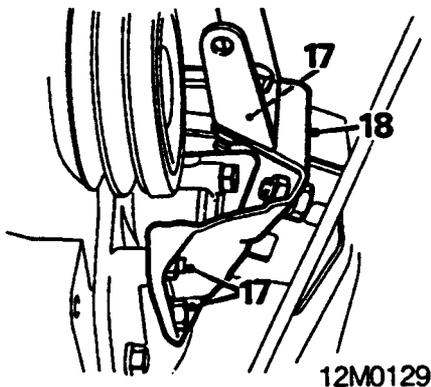

17. Remove nuts and bolt securing the radiator and engine mounting bracket to gearbox.
18. Remove bracket.

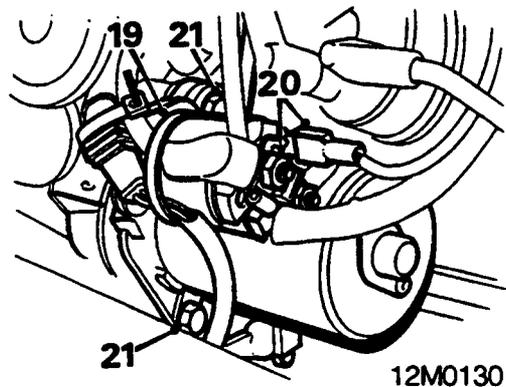

All models

19. Remove the cable tie securing leads to starter solenoid.
20. Disconnect leads from started solenoid.
21. Remove bolts securing starter motor and remove starter motor.

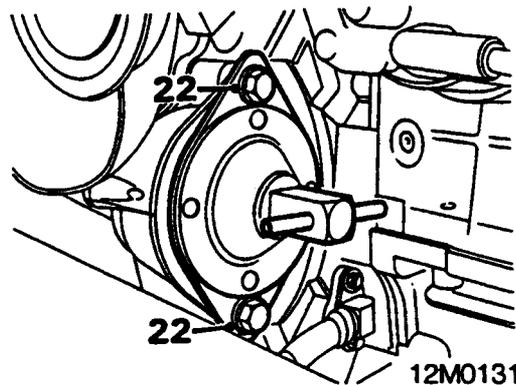

22. Fit flywheel locking tool and secure with 2 bolts.

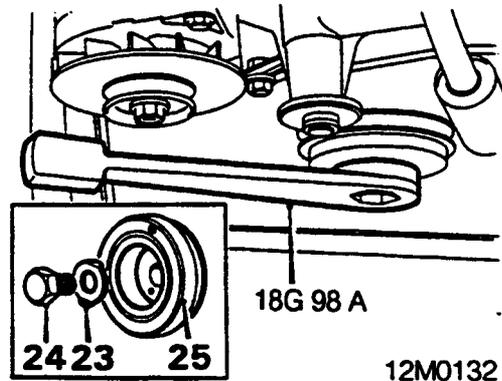

23. Bend back lock tab from crankshaft pulley bolt.
24. Remove crankshaft pulley bolt, using tool 18G 98A.
25. Remove crankshaft pulley.

**Refit**

1. Clean crankshaft pulley and ensure Woodruff key is in position in crankshaft.
2. Lubricate oil seal surface on pulley and fit pulley to crankshaft.
3. Fit new tab washer to pulley bolt.
4. Fit pulley bolt and tighten to 102 Nm.
5. Remove flywheel locking tool.
6. Secure crankshaft pulley nut with tab washer.
7. Fit starter motor and tighten bolts to 37 Nm.
8. Connect leads to starter solenoid and secure harness to solenoid, with a cable tie.

Manual gearbox models

9. Pivot mounting bracket up to gearbox and fit top bolt.
10. Fit top and bottom bolts securing bracket to gearbox and tighten to 22 Nm.
11. Fit radiator lower mounting bracket to engine mounting bracket and tighten bolts to 22 Nm.

Automatic gearbox models

12. Fit mounting bracket to gearbox and bolt and nuts to 22 Nm.
13. Lower jack, fit nuts and bolts securing engine mounting to subframe and tighten to 22 Nm.
14. Remove jack.

All models

15. Fit coolant pump pulley and drive belt.
16. Fit spacer and fan to pulley and tighten bolts to 11 Nm.
17. Adjust alternator drive belt tension, see **MAINTENANCE**.
18. Fit radiator, see **COOLING SYSTEM**.
19. Fit splash shield.
20. Remove stand(s) and lower vehicle.
21. Connect battery earth lead.

TIMING CHAIN AND GEARS

Service Repair No. 12.65.12.

Remove

1. Remove the timing cover, see **Timing cover oil seal**.

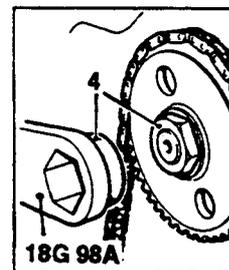
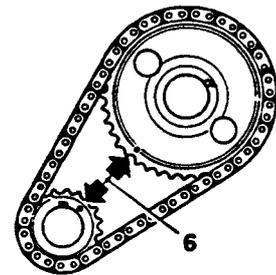
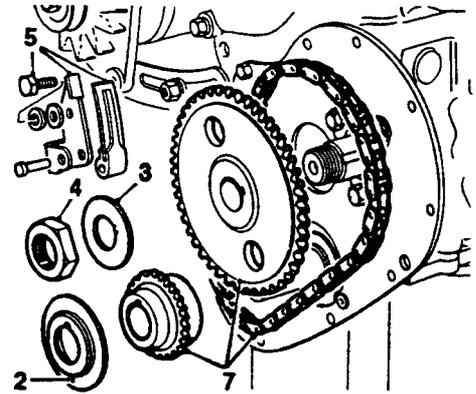

12M0985

2. Remove the oil thrower.
3. Tap back the lock washer tab on the camshaft gear retaining nut.
4. Using tool **18G98 A** unscrew the camshaft gear retaining nut, remove the lock washer.
5. Remove the retaining bolts and detach the timing chain tensioner.
6. Rotate the crankshaft until the two timing marks are aligned.
7. Gently lever off the camshaft and crankshaft gears complete with timing chain.

Refit

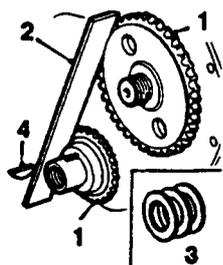

12M0986

1. Fit the timing gears without the chain.
2. Check the alignment of the gears with a straight edge.
3. Use feeler gauges to determine the thickness of shims required.
Shim size = 0.152 mm.
4. Remove the gears and the crankshaft driving key.
5. Fit the required thickness of shims to obtain the correct alignment.
6. Refit the driving key into the crankshaft.

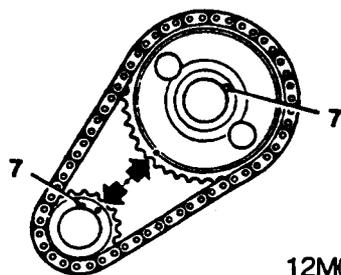

12M0987

7. Position the crankshaft key at TDC and the camshaft key at 2 o'clock.
8. Refit the timing gears and timing chain tighten camshaft nut to 88 Nm.
9. Refit the timing chain tensioner, and tension the chain by applying firm thumb pressure on the tensioner and tighten the bolts to 22 Nm.
10. Refit oil thrower, with the 'F' mark facing outwards.
11. Refit timing cover, see **Timing cover oil seal**.

TIMING COVER AND OIL SEAL

Service Repair No. 12.65.05.

Remove

1. Remove the crankshaft pulley, see **Crankshaft pulley**.

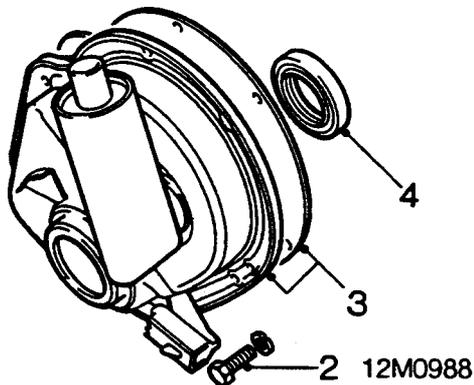

2. Remove bolts securing timing gear cover.
3. Lift off cover, remove gasket.
4. Remove oil seal from timing gear cover.

Refit

1. Lubricate new seal with engine oil.

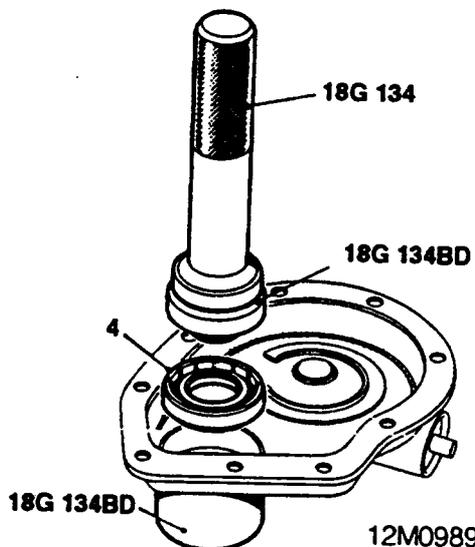

2. Using tool 18G134 BD support timing gear cover.
3. Position oil seal on tools 18G134/134 BD with the lips of the seal facing upwards.
4. Drift the seal into the timing gear cover.
5. Using a new gasket refit the timing gear cover, centralise the oil seal over the crankshaft by using tool 18G1044 .
6. Fit timing gear cover securing bolts and tighten to 16 Nm.
7. Refit the crankshaft pulley, see **Crankshaft pulley**.



ROCKER COVER

Service Repair No. 12.29.42.

Remove

1. Remove air cleaner:
SPi models, see MODULAR ENGINE MANAGEMENT SYSTEM.
Carburettor models, see CARBURETTER & IGNITION.
2. Release fasteners and remove splash shield.

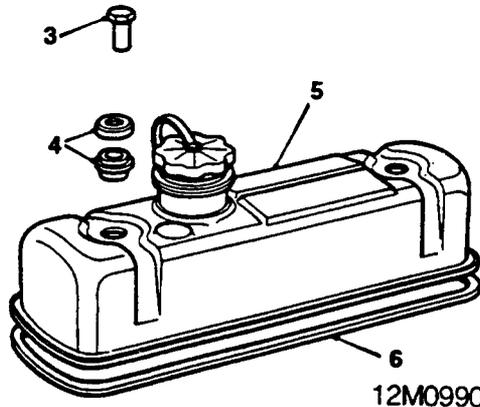

3. Remove the two nuts retaining the rocker cover.
4. Remove the cup washers and seals.
5. Lift off the rocker cover.
6. Remove all traces of the old gasket from the rocker cover and cylinder head faces.

Refit

1. Apply a thin coating of Bostik 1775 or equivalent impact adhesive to mating surfaces of rocker cover and gasket.
2. Allow adhesive to cure, and fit gasket.
3. Refit the rocker cover, seals and cup washers.
4. Tighten the rocker cover nuts to 5 Nm.
5. Refit air cleaner.

ROCKER SHAFT ASSEMBLY

Service Repair No.

Remove and refit - 12.29.54.

Overhaul - 12.29.55.

Remove

1. Drain cooling system, see **MAINTENANCE**.
2. Remove the rocker cover, see **Rocker cover**.

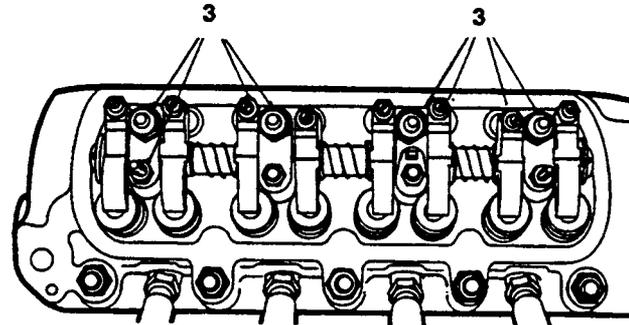

12M0991

3. Slacken evenly and remove the 8 nuts retaining the rocker shaft brackets to the cylinder head.
4. Remove the locking plate from No. 2 rocker shaft bracket.
5. Remove the rocker shaft assembly.

Note: Retain the push rods in their respective locations.

Overhaul

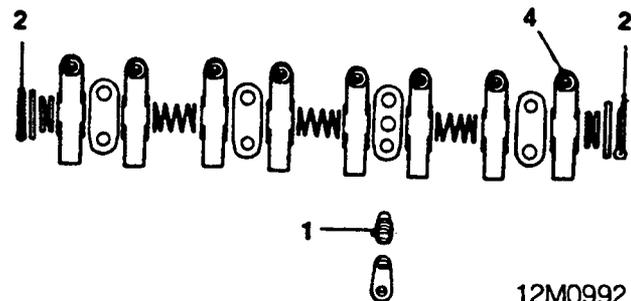
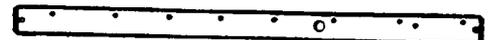

1. Remove the rocker shaft locating screw from No.2 rocker shaft bracket.
2. Remove the split pins from each end of the rocker shaft.
3. Slide off the components and retain them in their fitted order.
4. Renew any rocker adjusting screw that shows signs of wear, and any rockers that are worn on the valve contact face or bore.
5. Fit the rocker shaft to No.2 rocker bracket, tighten the shaft locating screw.
6. Assemble the remaining components to the shaft in the order removed.

Refit

1. Position the rocker shaft assembly, locating the rocker screws in the push - rods.
2. Fit the locking plate to No.2 rocker shaft bracket.

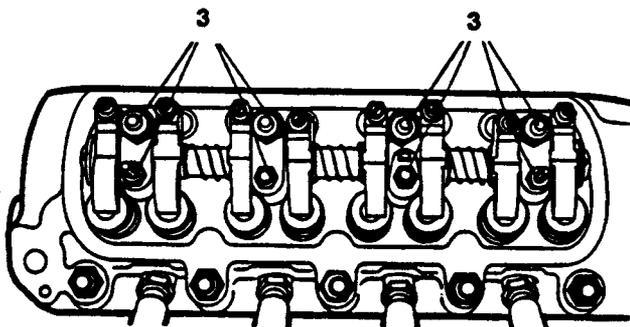

12M0991

3. Working in a sequence, tighten the cylinder head bolts initially to 34 Nm then to 68 Nm.
4. Tighten the rocker shaft nuts to 32 Nm.
5. Adjust the valve clearances. see **MAINTENANCE**.
6. Refit the rocker cover. see **Rocker cover**.
7. Refill cooling system. see **MAINTENANCE**.

TAPPETS

Service Repair No. 12.29.57

Remove

1. Remove the engine and gearbox assembly, see **Engine and gearbox**.
2. Separate the gearbox assembly from the engine block:
Manual models, see MANUAL GEARBOX.
Automatic models, see AUTOMATIC GEARBOX.
3. Remove the rocker shaft, see **Rocker shaft assembly**.
4. Withdraw the push rods and retain them in their installed order.
5. Remove distributor drive shaft, see **Distributor drive shaft**. *Carburetter models, remove the fuel pump, see CARBURETTER & IGNITION.*
6. Remove the timing chain and gears, see **Timing chain and gears**.
7. Lay the engine on its side to facilitate camshaft removal.
8. Remove the camshaft, see **Camshaft**.
9. Withdraw the tappets down through the bottom of their bores.

Note: If the tappets are to be refitted keep them in their installed order.

Refit

1. Examine the faces of the tappets for pitting and wear, renew where necessary.
2. Lubricate the tappets with clean engine oil and fit into cylinder block.
3. Refit the camshaft, see **Camshaft**.
4. Fit the camshaft lock plate and tighten the bolts to 11 Nm.
5. Refit the timing chain and gears, see **Timing chain and gears**.
6. Refit the distributor drive shaft, see **Distributor drive shaft**.
7. Insert the push rods in their correct positions.
8. Refit the rocker shaft, see **Rocker shaft assembly**.
9. Refit the gearbox to engine:
Manual models, see MANUAL GEARBOX.
Automatic models, see AUTOMATIC GEARBOX.
10. Refit the engine and gearbox assembly, see **Engine and gearbox**.



OIL PRESSURE RELIEF VALVE

Service Repair No. 12.60.56.

Remove

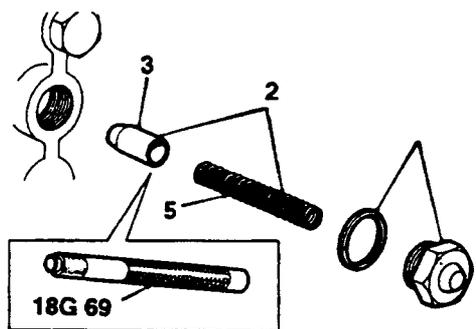

12M0993

1. Remove the valve cap and washer.
2. Remove the spring and relief valve.
3. Check the face of the valve is not pitted or scored, and the valve is seated correctly, renew if necessary.
4. If the valve is only lightly pitted lap the valve onto its seat using tool **18G69** and fine grade grinding paste.

CAUTION: Thoroughly clean the valve and its seating after lapping in.

5. Check the length of the spring.
Free length = 72.64 mm.
6. Renew if necessary.

Refit

1. Refit the spring and relief valve.
2. Refit the valve cap and washer.

ENGINE LEFT - HAND MOUNTING

Service Repair No. 12.45.11.

Remove

1. Remove the radiator assembly, see **COOLING SYSTEM**.
2. Support the engine on a hydraulic jack.

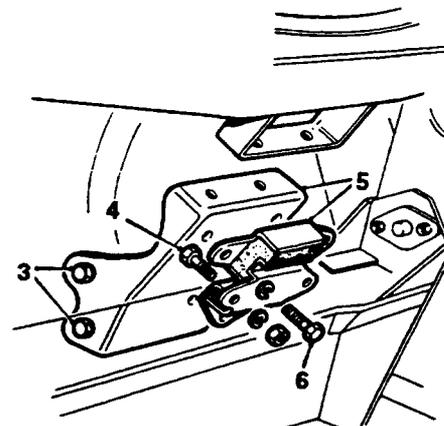

12M0994

3. Remove two bolts securing the mounting bracket to the gearbox.
4. Remove two nuts and bolts securing the mounting to the subframe.
5. Remove the mounting bracket assembly.
6. Remove two bolts securing the left - hand mounting to the mounting bracket and remove.

Refit

1. Position the left - hand mounting to the mounting bracket.
2. Refit the mounting bracket assembly, and tighten the mounting bolts to 22 Nm.
3. Tighten mounting assembly to sub - frame nuts and bolts to 22 Nm.
4. Fit bolts securing the mounting bracket to the gearbox and tighten to 22 Nm.
5. Remove hydraulic jack.
6. Refit the radiator assembly, see **COOLING SYSTEM**.

ENGINE

ENGINE RIGHT - HAND MOUNTING

Service Repair No. 12.45.12.

Remove

1. Remove the clutch cover, see **CLUTCH**.

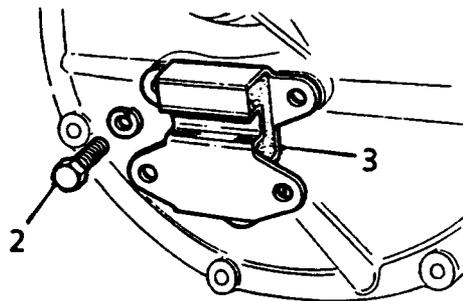

2. Remove the bolts securing the mounting to the clutch cover.
3. Remove right - hand engine mounting.

Refit

1. Fit mounting to clutch cover and tighten bolts to 18 Nm.
2. Refit clutch cover, see **CLUTCH**.

FLYWHEEL AND STARTER RING GEAR

Service Repair No. 12.53.19

Remove

1. Remove clutch and flywheel, see **CLUTCH**.
2. Remove the bolts securing the clutch pressure plate to flywheel, see **CLUTCH**.

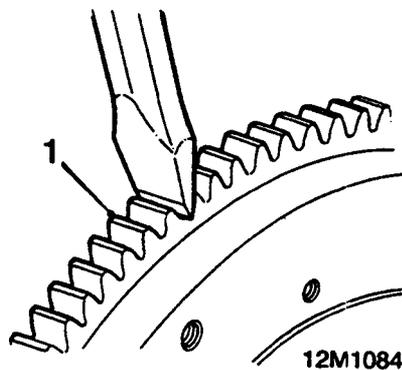

Starter ring gear remove

1. Apply a chisel to the root of the tooth to split and remove the ring gear from the flywheel.

CAUTION: SPi models, must be taken not to damage the flywheel and reluctor ring.

Starter ring gear refit

1. Heat ring gear evenly to 350°C, indicated by the light BLUE colour. Locate the ring gear on the flywheel ensuring the ring gear is properly located against its flange around its complete diameter.

Refit

1. Remove the bolts securing the clutch pressure plate to flywheel, see **CLUTCH**.
2. Refit clutch and flywheel, see **CLUTCH**.

CARBURETTER & IGNITION

CONTENTS

Description and Operation

	Page
Component locations	2
Key to the carburetter components	4
Distributor components - Lucas 65DM4	5
Ignition system	6

Repairs

	Page
Throttle cable	1
Mixture control (choke) cable	2
Air cleaner assembly	3
Carburetter	3
Carburetter overhaul	4
Ignition coil	6
Amplifier module	7
Distributor - Lucas 65DM4	7
Thermal vacuum switch	9
Charcoal canister	9



CARBURETTER & IGNITION

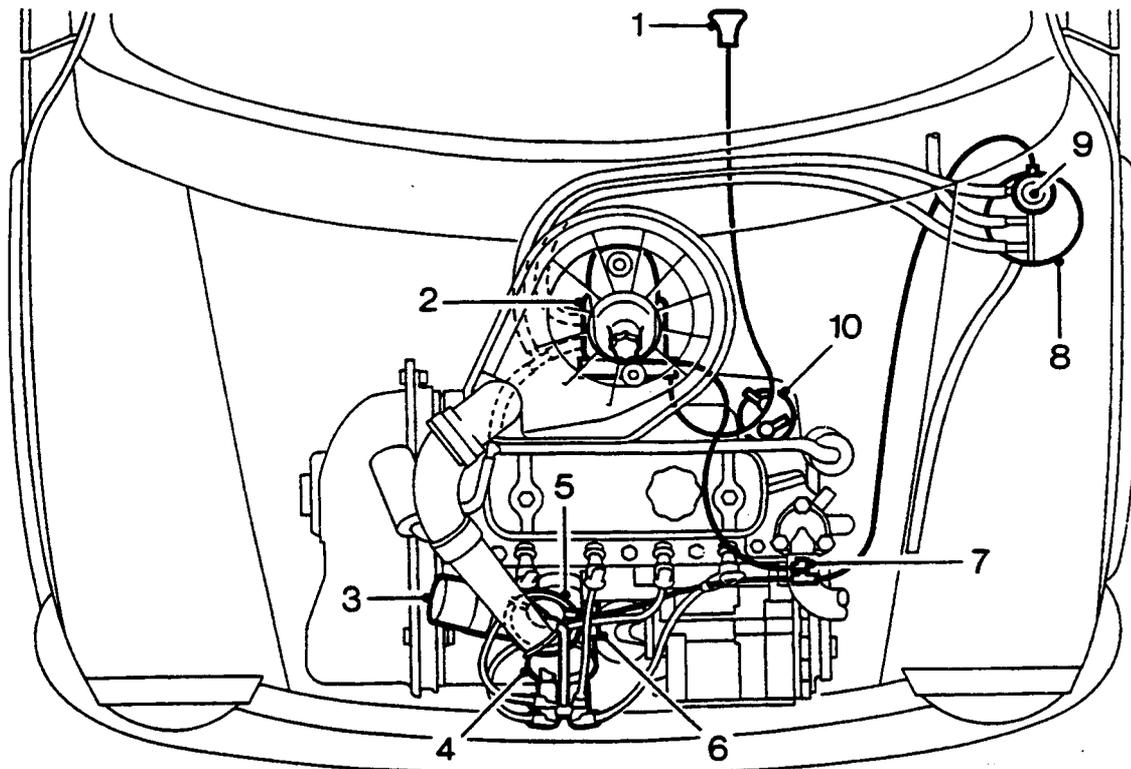

19M0558

COMPONENT LOCATIONS

- | | |
|------------------------------|----------------------------|
| 1. Choke control | 7. Thermal vacuum switch |
| 2. Carburetter | 8. Charcoal canister |
| 3. Ignition coil | 9. Purge valve |
| 4. Distributor cap | 10. Fuel pump - mechanical |
| 5. Vacuum advance capsule | |
| 6. Ignition amplifier module | |

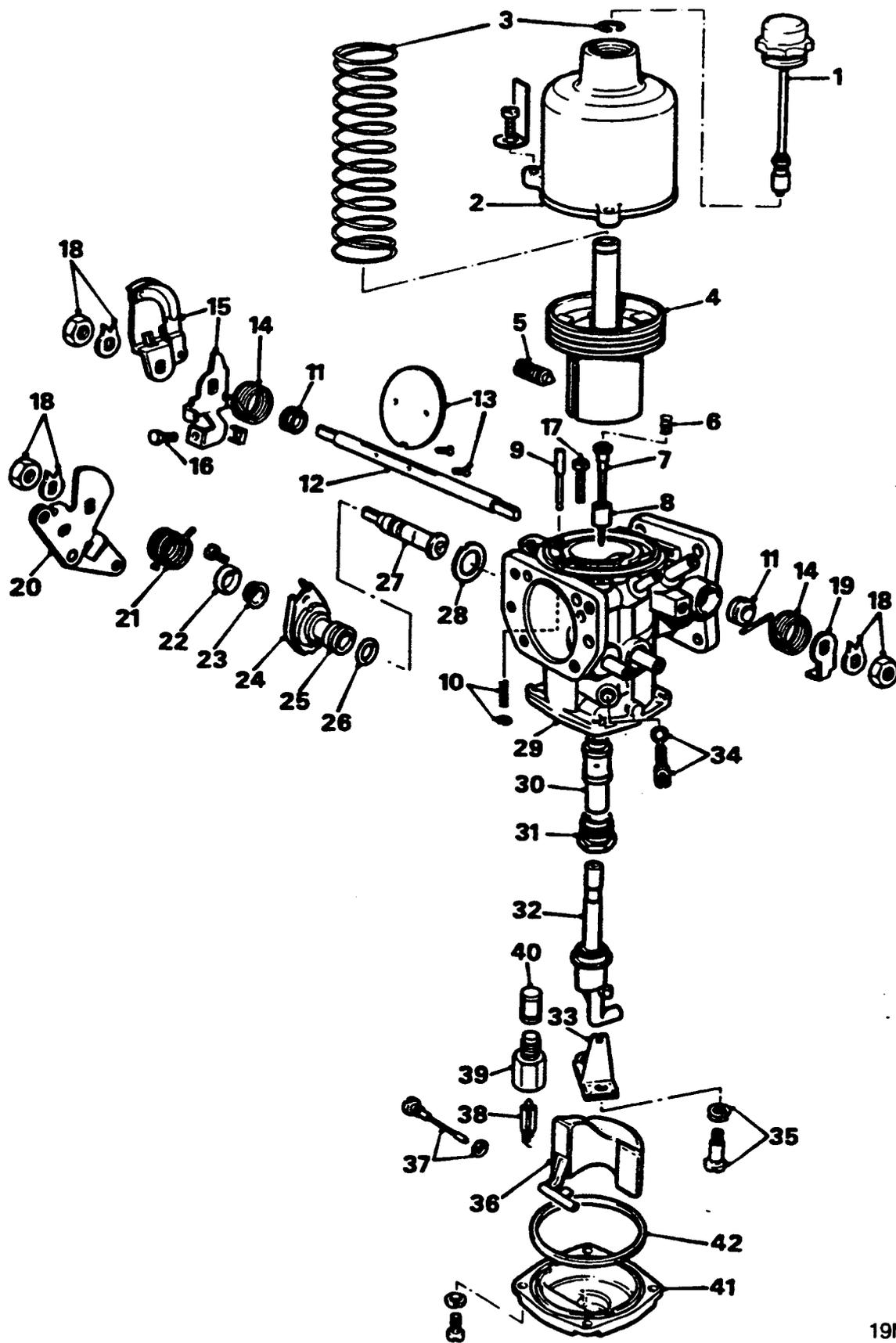

19M0561

CARBURETTER & IGNITION

KEY TO THE CARBURETTER COMPONENTS

1. Piston damper
2. Suction chamber
3. Piston Spring and 'C' clip
4. Piston
5. Needle retaining screw
6. Needle spring
7. Jet needle
8. Needle guide
9. Lifting pin
10. Lifting pin spring and circlip
11. Throttle spindle seal
12. Throttle spindle
13. Throttle disc and screws
14. Throttle return springs
15. Throttle lever and progressive throttle cam
16. Fast idle adjustment screw
17. Throttle adjustment screw
18. Spindle nuts and tab washer
19. Throttle return spring lever
20. Mixture control lever and fast idle cam
21. Mixture control lever return spring
22. Dust cap
23. Spindle seal
24. Retaining plate
25. Mixture control body
26. 'O' ring seal
27. Mixture spindle
28. Mixture control body gasket
29. Carburetter body
30. Jet bearing
31. Jet bearing nut
32. Jet assembly
33. Bi - metal jet lever
34. Jet adjusting screw and seal - mixture
35. Jet retaining screw and spring
36. Float
37. Float pivot and seal
38. Float needle
39. Needle seat
40. Fuel filter
41. Float chamber cover
42. Cover seal



DISTRIBUTOR COMPONENTS - LUCAS 65DM4

1. Distributor cap, brush and spring
2. Rotor arm
3. Upper housing
4. Vacuum advance capsule
5. Stator pack, thrust washers and circlip
6. Pick-up coil
7. Clamp ring
8. Reluctor, centrifugal advance and shaft assembly
9. Internal thrust washer
10. Lower housing
11. 'O' ring seal
12. External thrust washer and drive dog
13. Connector and gasket
14. Amplifier module

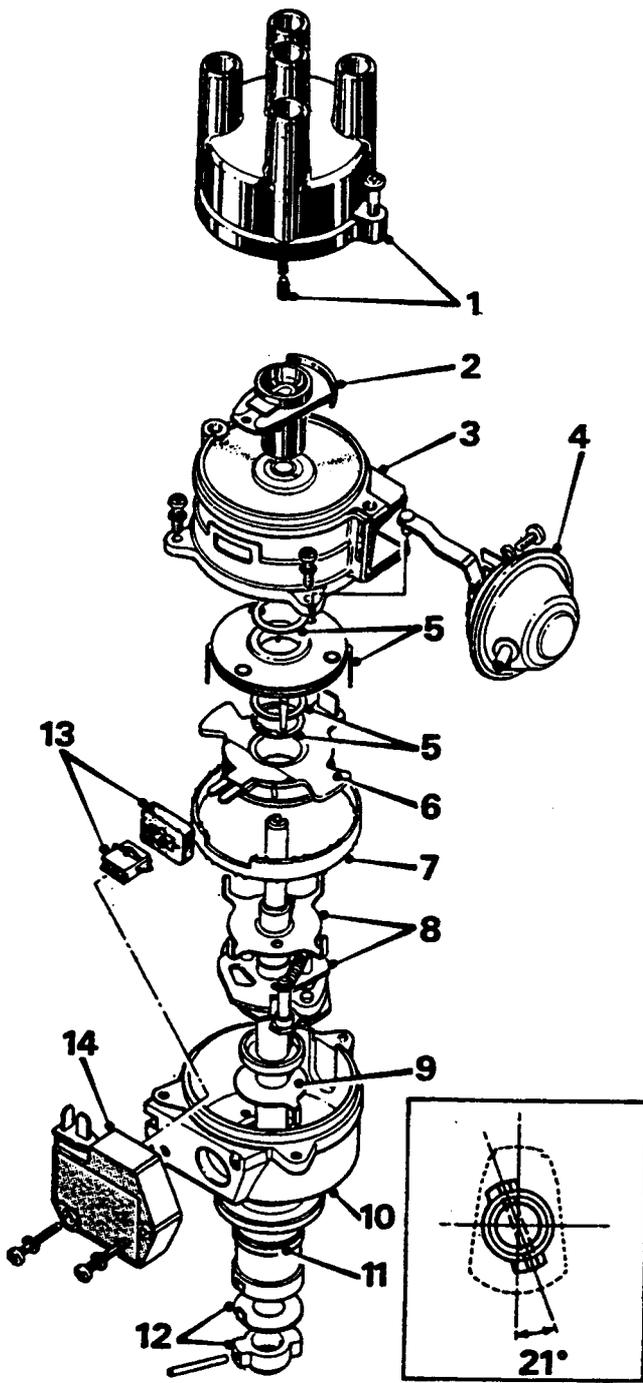

19M0562

IGNITION SYSTEM

Lucas 65 DM4 distributor

The variable reluctance electronic distributor incorporates standard centrifugal and vacuum advance components and an externally mounted amplifier module.

The distributor housing is in two parts, the upper housing and the lower housing. The upper housing contains the stator pack, pick - up winding and a bearing carrying the main shaft and rotor arm. The vacuum advance capsule is also carried externally by the housing. The lower housing contains the centrifugal advance mechanism and reluctor and carries the amplifier unit externally, this is connected electrically to the pick - up winding in the upper housing.

Ignition timing

When the distributor shaft rotates the reluctor poles pass the pick - up winding.

As each pole passes it disturbs the weak magnetic field created by the pick - up and causes a signal current to flow.

As the signal from the pick - up exceeds a threshold level determined by engine speed, a high voltage transistor in the amplifier is switched on and coil current starts to flow. Once the coil current has reached the required level, it is held constant until the transistor is switched off thus triggering the spark. As engine speed increases so the threshold level is reduced to allow the coil time to produce the required voltage at the advanced timing point.

Catalyst and non - evaporative loss equipment

Charcoal canister

A charcoal canister is used for the temporary storage of fuel vapour from the fuel tank until the vapour can be purged from the canister into the engine and burned.

The charcoal canister is purged when the purge control valve is open, fresh air is drawn through the purge air hose, through the charcoal canister and into a port in the carburetter.

Vehicles are also fitted with a dual purpose thermal vacuum switch which controls both ignition timing retard and purge control. The thermal vacuum switch is mounted in the top radiator hose.

Ignition retard

The thermal vacuum switch is connected to the vacuum pipe between the distributor and the carburetter. When the engine coolant temperature is below 70°C the vacuum switch prevents

vacuum advance from taking place. This retardation of the ignition causes increased exhaust gas temperatures which allow the catalyst to reach its efficient operating temperature very quickly.

Once the coolant temperature has risen above 70°C the vacuum switch opens and normal vacuum advance is restored.

Purge control

Connected into the distributor side of the vacuum switch is a pipe to the purge control valve. The purge control valve opens at temperatures above 70°C and at speeds above idle, allowing fuel vapour from the charcoal canister to be drawn into the carburetter for combustion. The valve remains closed when the engine is cold and at idling speed to protect engine tune and catalyst performance. If the charcoal canister was purged during cold running or at idling speed, the additional enrichment in fuel mixture would delay catalyst light - off time and cause erratic idle.



THROTTLE CABLE

Service Repair No. 19.20.23

Remove

1. Remove air cleaner assembly, see **Air cleaner assembly**.

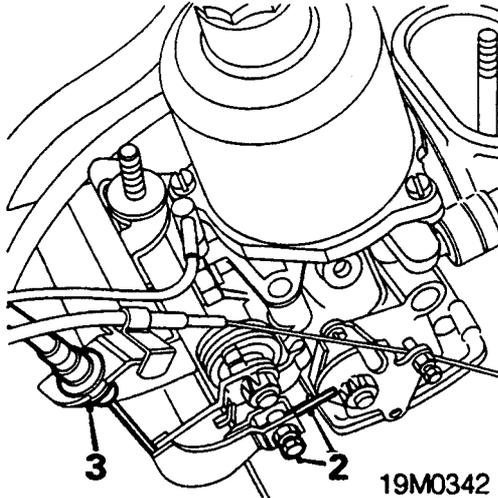

2. Slacken throttle cable trunnion and release cable.
3. Release throttle cable from abutment bracket.
4. Release air intake duct from heater unit under fascia.

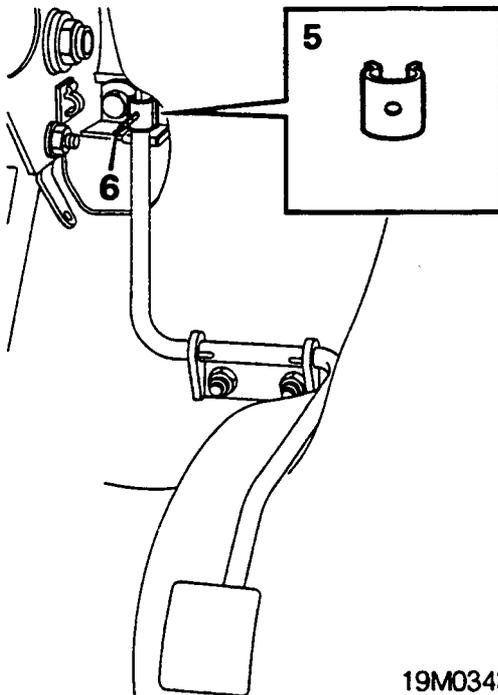

5. Remove clip securing inner cable to pedal.
6. Release cable from throttle pedal.
7. Remove cable assembly from vehicle.

Refit

1. Position throttle cable to bulkhead.
2. Connect inner cable to throttle pedal and secure with clip.
3. Fit air intake duct to heater unit.
4. Fit throttle cable to abutment bracket.
5. Fit throttle cable through throttle cable trunnion.
6. Tension cable and tighten trunnion.
7. Push the throttle pedal to the floor and check that the throttle opens fully. Check that the throttle returns to the idle position when the pedal is released.
8. Refit air cleaner assembly, see **Air cleaner assembly**.

CARBURETTER & IGNITION

MIXTURE CONTROL (CHOKE) CABLE

Service Repair No. 19.20.13

Remove

1. Remove the air cleaner, see **Air cleaner assembly**.

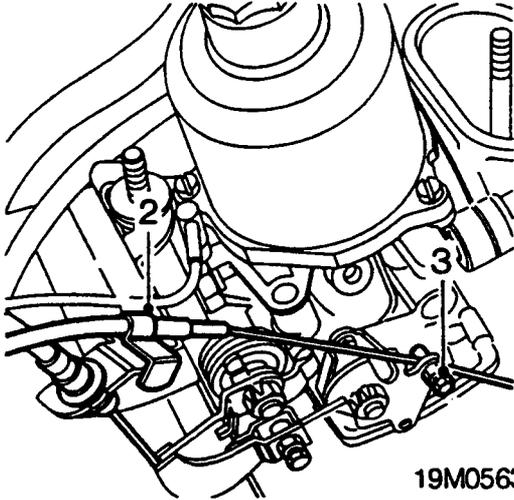

2. Remove the clip securing the outer cable to the abutment bracket.
3. Slacken the mixture control cable trunnion and release the cable.
4. Disconnect the 2 Lucars from the heater switch.
5. Remove 2 screws securing the heater to fascia and lower the heater assembly.

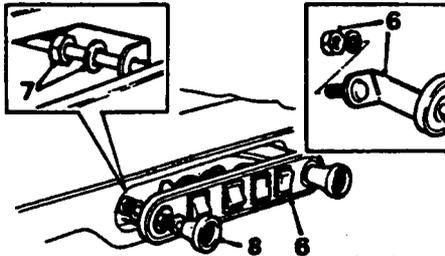

6. Remove 2 nuts securing the switch panel pull the panel forward from the fascia.
7. Unscrew the cable securing nut, note the locking washer.
8. Pull the cable complete through the bulkhead grommet and switch panel.

Refit

1. Feed the cable through the switch panel, fit the locking washer and nut, tighten nut to secure the cable to the switch panel.
2. Feed the cable through the grommet in the bulkhead.
3. Position switch panel in fascia secure with nuts.
4. Raise heater unit, fit screws to secure heater to the fascia.
5. Connect 2 Lucars to heater switch.
6. Route cable through engine compartment and secure to abutment bracket with clip.
7. Fit mixture control inner cable through trunnion and tighten trunnion.
8. Check that the mixture control cable has $\frac{1}{16}$ in (2 mm) free movement before the cable starts to pull on the lever.
9. Adjust fast idle speed, see **MAINTENANCE**.
10. Refit air cleaner, see **Air cleaner assembly**.



AIR CLEANER ASSEMBLY

Service Repair No.
Air Cleaner Assembly - 19.10.01

Remove

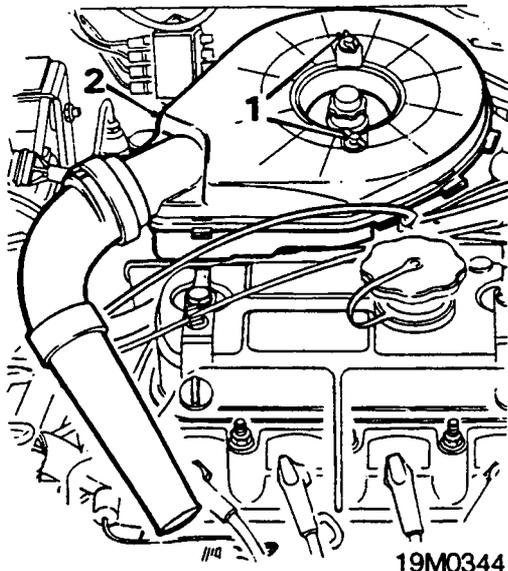

1. Remove 2 wing nuts securing air cleaner to carburetter.
2. Remove air cleaner from carburetter.
3. Remove air cleaner to carburetter seal.

Refit

1. Clean mating faces of air cleaner and carburetter, fit carburetter seal to air cleaner.
2. Position air cleaner to carburetter, ensure the hose between the manifold hot box and air cleaner is properly located.
3. Fit and tighten wing nuts.

CARBURETTER

Service Repair No. 19.15.09

Refit

1. Disconnect battery earth lead.
2. Remove air cleaner assembly, see Air cleaner assembly.

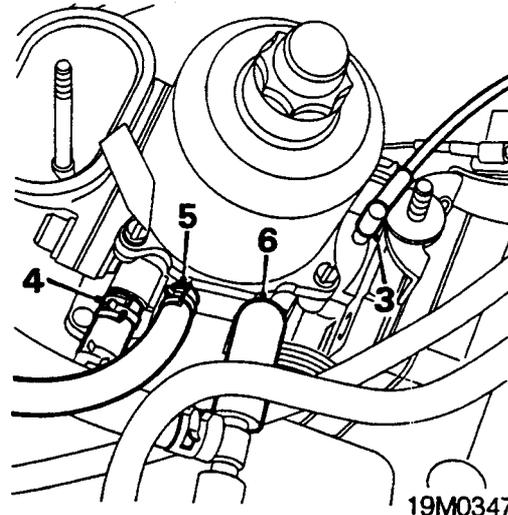

3. Disconnect vacuum pipe from carburetter.
4. Release clip and disconnect fuel hose from carburetter.

CAUTION: Plug the connections.

5. Release clip and disconnect charcoal canister hose from carburetter.

CAUTION: Plug the connections.

6. Disconnect breather hose from carburetter.

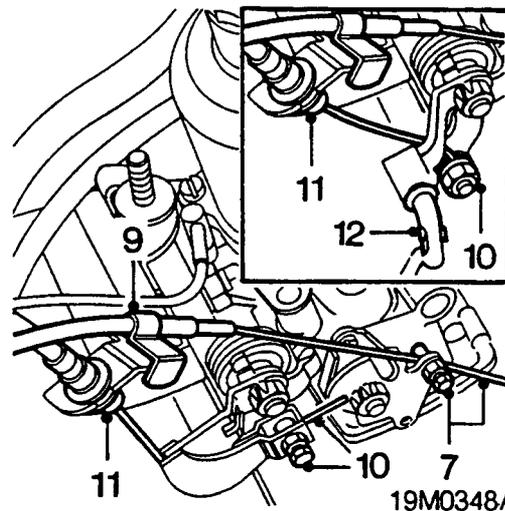

7. Slacken mixture control cable trunnion and release mixture control cable.
8. Remove mixture control cable trunnion.
9. Remove clip securing mixture control outer cable to abutment bracket.
10. Slacken throttle cable trunnion and release throttle cable.
11. Release throttle cable from abutment bracket.
12. *Automatic gearbox models:* Disconnect downshift rod from throttle lever.

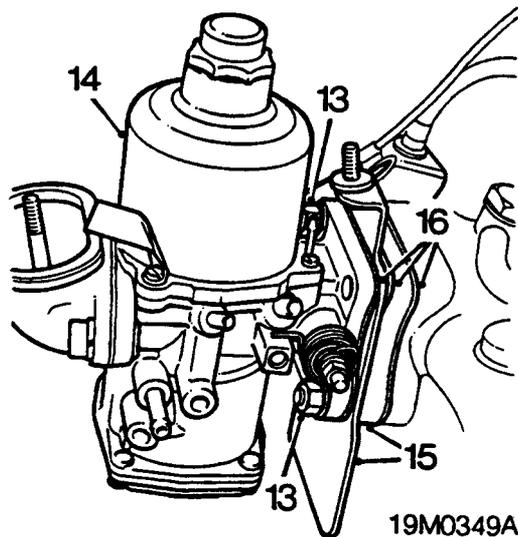

13. Remove 2 nuts securing carburetter to inlet manifold, collect washers.
 14. Remove carburetter from inlet manifold.
 15. Remove abutment bracket and insulating block.
 16. Remove and discard 3 gaskets from abutment bracket and insulating block.
- Do not carry out further dismantling if component is removed for access only**
17. Remove 2 screws securing air cleaner intake adapter to carburetter.
 18. Remove air cleaner intake adapter and discard gasket.
 19. Clean mating faces of carburetter and air cleaner intake adapter.
 20. Fit new gasket and align air cleaner intake adapter to carburetter, fit and tighten screws.

Refit

1. Clean mating faces of carburetter, abutment bracket, insulating block and inlet manifold.
2. Fit new gaskets to insulating block and abutment bracket.
3. Fit insulating block and abutment bracket to inlet manifold.
4. Fit carburetter to inlet manifold, tighten nuts to 22 Nm.
5. *Automatic gearbox models:* Connect downshift rod to throttle lever.
6. Fit throttle cable to abutment bracket.
7. Fit throttle cable through throttle cable trunnion.
8. Tension cable and tighten trunnion.
9. Push the throttle pedal to the floor and check that the throttle opens fully. Check that the throttle returns to the idle position when the pedal is released.
10. Secure mixture control outer cable to abutment bracket with clip.
11. Fit mixture control cable trunnion to mixture control lever.
12. Fit mixture control inner cable through trunnion and tighten trunnion.

13. Remove plugs from end of hoses.
14. Connect fuel hose to carburetter and secure with clip.
15. Connect hose from charcoal canister to carburetter and secure with clip.
16. Connect breather hose to carburetter.
17. Connect vacuum pipe to carburetter.
18. Top up carburetter piston damper.
19. Refit air cleaner assembly, see **Air cleaner assembly**.
20. Connect battery earth lead.

CARBURETTER OVERHAUL

Service Repair No. 19.15.17

Dismantling

1. Remove the carburetter, see **Carburetter**.
2. Thoroughly clean all exterior surfaces of the carburetter before dismantling.
3. Mark the bottom cover plate and body for reference on reassembly. Remove 4 screws securing cover to carburetter, remove cover and sealing ring.
4. Remove the jet adjusting screw and seal
5. Remove the jet adjusting lever retaining screw and spring. Withdraw the jet complete with adjusting lever and disengage lever.
6. Remove the float pivot spindle, float, needle valve and valve seat
7. Unscrew and remove the piston damper.
8. Remove 3 screws securing the suction chamber, remove suction chamber.
9. Remove the spring clip from the top of the piston rod and withdraw the piston and spring from the suction chamber. Drain the oil from the piston rod.
10. Unscrew the needle guide locking screw and withdraw the needle, guide and spring. Unscrew the jet bearing nut and withdraw the bearing
11. Remove the fast idle cam lever retaining nut and locking washer, with the return spring held against the carburetter body, prise off the cam lever and remove the return spring.

Note: Before removal note the location of the ends of the fast idle cam return spring.

12. Remove the 2 screws securing the mixture control body retaining plate to the carburetter.
13. Remove the dust cap, retainer plate, mixture control body and gasket from carburetter.
14. Remove the seal from the end of the mixture control body spindle, withdraw the spindle and remove the 'O' ring.
15. Remove the retaining nut, lock washer and plain washer securing the throttle lever and progressive throttle cam, remove the levers. Remove the throttle return spring lever and



spring from the other end of the spindle.

Note: Before removal note the location of the ends of the throttle lever return spring.

16. Close the throttle, mark the position of the throttle disc in relation to the carburetter flange and remove the 2 throttle disc retaining screws; open the throttle and carefully withdraw the disc from the throttle spindle.
17. Withdraw the throttle spindle, and remove its seal.

Note: Observe which way the throttle spindle is fitted in relation to the carburetter body,

18. Examine the throttle spindle and bearings for excessive play, renew if necessary.
19. Examine the float needle and seating for excessive wear, renew if necessary.
20. Discard all seals, gaskets and 'O' rings.
21. Examine the carburetter body for cracks and damage. Check the security of the brass connections and the piston key.
22. Clean the inside of the suction chamber and piston rod guide with fuel or denatured alcohol and wipe dry. Abrasives must not be used.

Reassembling

1. Fit the piston into the suction chamber, without the damper and spring, hold the assembly horizontally and spin the piston; the piston should spin freely in the suction chamber without any tendency to stick. If there is any tendency for the piston to stick, the suction chamber and piston must be replaced as an assembly.
2. Insert the throttle spindle into the carburetter body and fit the throttle disc onto the spindle in its original position.
3. Fit new throttle disc retaining screws, ensure that the throttle disc is correctly positioned and fully closes before tightening the retaining screws. Spread the split ends of the screws sufficiently to prevent turning.
4. Fit new throttle spindle end seals. Fit the throttle return spring, progressive throttle cam and throttle lever, lock washer and retaining nut. Tighten nut and secure by bending the tabs up on the lock washer.
5. Fit the throttle return spring, throttle return spring lever, lock washer and nut to the other end of the spindle. Tighten nut and secure by bending the tabs up on the lock washer.
6. Fit new 'O' rings to the mixture control body. Fit the mixture control body onto the spindle and fit the dust cap and spindle seat on the other end.
7. Fit the mixture control body to the carburetter with the cut-out in the mixture

control body flange at the top. Fit and tighten the 2 retaining screws.

8. Fit the return spring, fast idle cam lever, lock washer and retaining nut. Tighten nut and secure by bending the tabs up on the lock washer.
9. Fit the jet bearing and nut.

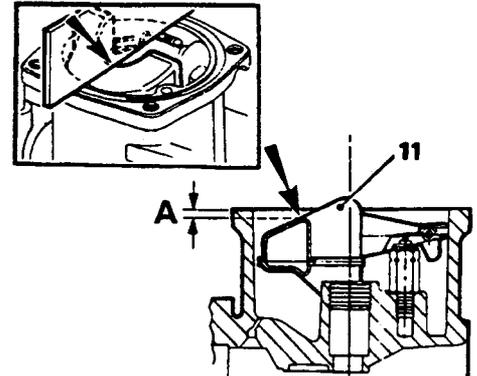

19M0565

10. Fit the needle valve seat, needle valve, float, pivot spindle and washer.
11. Hold the carburetter inverted so that the weight of the float holds the needle valve closed and check that dimension 'A' is correct. Adjust the float height if necessary by carefully bending the float arm. Check that the float pivots easily on the spindle.
Dimension 'A' = 1.0 ± 0.5 mm

Note: Use a straight edge positioned across the face of the float chamber when checking the float height.

12. Fit the jet assembly to the bi-metal jet adjusting lever and ensure that the jet head moves freely in the slot. Fit and tighten the jet retaining screw and spring.
13. Set the jet flush with bridge in the carburetter body by screwing in the mixture screw.

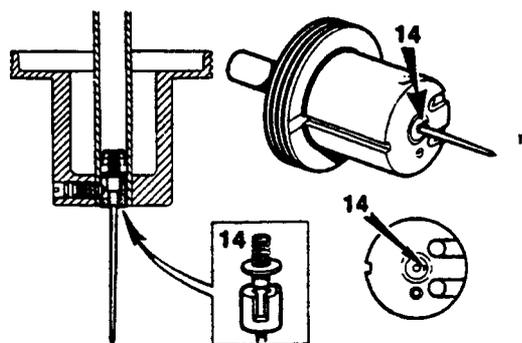

19M0566

14. Fit the correct size needle to the piston, see **INFORMATION - ENGINE TUNING DATA**. Use a new retaining screw and ensure that the groove in the needle guide aligns with the screw hole the piston and that the needle guide is flush with the base of the piston.
15. To prevent the piston spring from being 'wound up' during assembly, temporarily fit the piston and suction chamber, less the piston spring, to the carburetter body and using a pencil, mark their positions relative to each other.
16. Remove the suction chamber, fit the piston spring.
17. Hold the suction chamber above the piston, align the pencil marks and carefully lower the chamber over the piston spindle. Fit the securing screws and tighten them evenly to prevent distortion. Lift the piston and fit the spring clip to the piston rod.
18. Top up the piston damper and fit the cap.
19. Fit the carburetter to the engine, see **Carburetter**.
20. Check/adjust carburetter, see **MAINTENANCE**.

IGNITION COIL

Service Repair No. 18.20.32

Remove

1. Remove air cleaner assembly, see **Air cleaner assembly**.
2. Release 2 turnbuckles securing splash shield to rocker cover brackets.

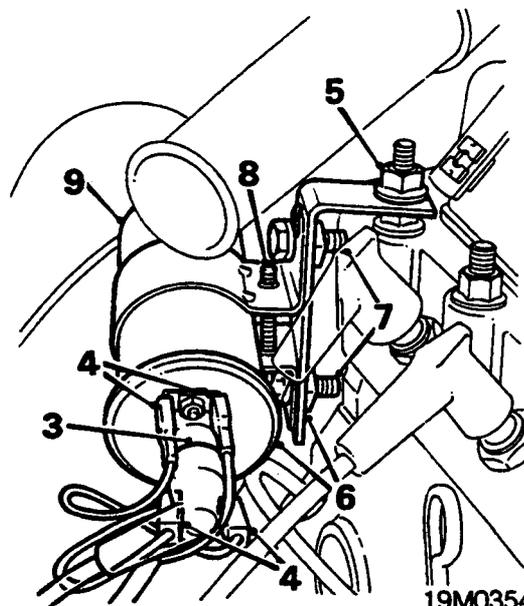

19M0354

3. Disconnect h.t. lead.
4. Disconnect 4 Lucars from coil.
5. Remove nut securing coil mounting bracket to cylinder head.
6. Remove coil and mounting bracket.
7. Slacken 2 bolts securing coil to mounting bracket.
8. Slacken coil mounting bracket screw.
9. Remove coil from mounting bracket.

Refit

1. Fit mounting bracket to coil and tighten screw.
2. Tighten bolts securing coil to mounting bracket.
3. Position coil and mounting bracket to cylinder head, fit and tighten nut.
4. Connect Lucars to coil terminals.
5. Connect h.t. lead to coil.
6. Secure splash shield to rocker cover brackets.
7. Refit air cleaner assembly, see **Air cleaner assembly**.



AMPLIFIER MODULE

Service Repair No. 18.20.30

Remove

1. Remove air cleaner assembly, see **Air cleaner assembly**.
2. Release 2 turnbuckles securing splash shield to rocker cover brackets.

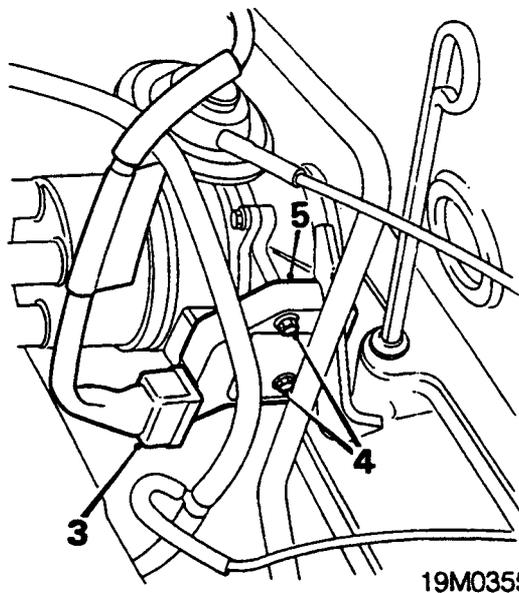

3. Disconnect multiplug from amplifier module.
4. Remove 2 bolts securing module to distributor.
5. Remove amplifier module.

Refit

1. Ensure mating faces on amplifier module and distributor are clean, smear with high conductive silicon grease.
2. Fit module to distributor and tighten bolts to 5 Nm.
3. Connect multiplug to amplifier module.
4. Secure splash shield to rocker cover brackets.
5. Refit air cleaner assembly, see **Air cleaner assembly**.

DISTRIBUTOR - LUCAS 65DM4

Service Repair No. 18.20.20

Remove

1. Disconnect battery earth lead.
2. Remove the front grille, see **BODY - Repairs**.
3. Release 3 turnbuckles and remove splash shield.
4. Disconnect the ht leads from the spark plugs.

Note: Mark the fitted position of the ht leads before disconnecting.

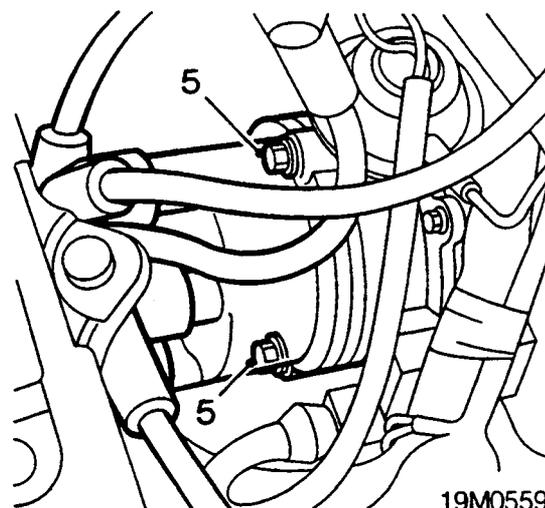

5. Remove 2 bolts securing the distributor cap, remove distributor cap.
6. Rotate the crankshaft to bring No. 1 piston to TDC on its compression stroke. The rotor arm should now be aligned to No. 1 segment in the distributor cap.

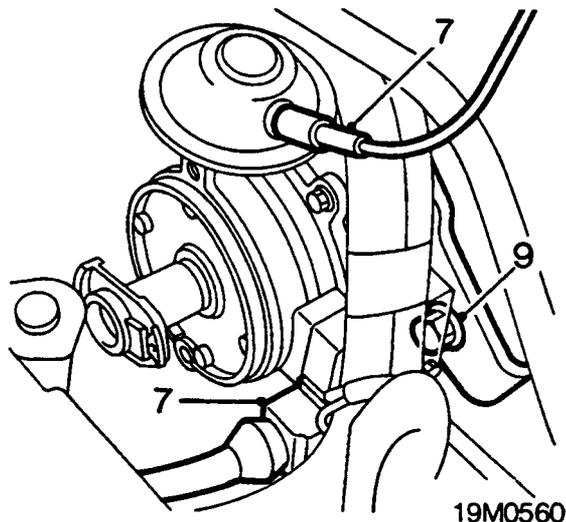

7. Disconnect the vacuum pipe from the vacuum unit and the multiplug from the amplifier module.
8. Mark the distributor body to cylinder block alignment for fitting reference.
9. Release the distributor clamp bolt and noting the position of the rotor arm and the vacuum advance capsule, withdraw the distributor.

Refit

1. Apply a smear of clean oil to the 'O' ring on the distributor body.
2. Ensure that No. 1 piston is at TDC compression and position the distributor for fitting with its vacuum unit in the 12 o'clock position to ensure the amplifier module is well clear of the starter.
3. Fit the distributor into position, at the same time turning the rotor arm towards No. 1 segment.
4. As the distributor is pushed fully home, ensure that the drive dog engages in the slot in the distributor shaft.

Note: The slots in the distributor drive shaft and the lugs on the distributor drive dog are offset and can only be engaged in one position.

5. Turn the distributor body until the reference marks made during removal are aligned.
6. Check that the rotor arm is aligned with No. 1 segment in the distributor cap.
7. Lightly tighten the distributor clamp bolt.
8. Connect the amplifier unit multiplug.
9. Fit the distributor cap and leads, connect the battery.
10. Check ignition timing, see **MAINTENANCE**.
11. Connect the vacuum pipe to the vacuum unit.
12. Position splash shield and secure with turnbuckles.
13. Refit front grille, see **BODY - Repairs**.



THERMAL VACUUM SWITCH

Service Repair No. 17.15.41

Remove

1. Release 2 turnbuckles securing splash shield to rocker cover brackets.

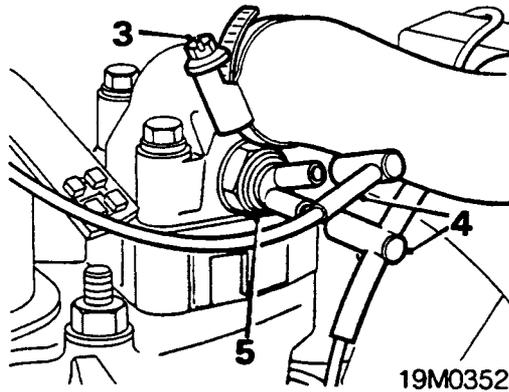

2. Position drain tin to collect spillage.
3. Slacken clip and release radiator top hose from thermostat housing.
4. Disconnect 2 vacuum pipes from thermal vacuum switch.
5. Remove thermal vacuum switch.

Refit

1. Clean mating faces of thermal vacuum switch and thermostat housing.
2. Apply thread sealant (e.g. Loctite 542 or 577) to the thermal vacuum switch.
3. Fit thermal vacuum switch and tighten to 10 Nm.
4. Connect radiator top hose to thermostat housing and tighten hose clip.
5. Connect 2 vacuum pipes to thermal vacuum switch.

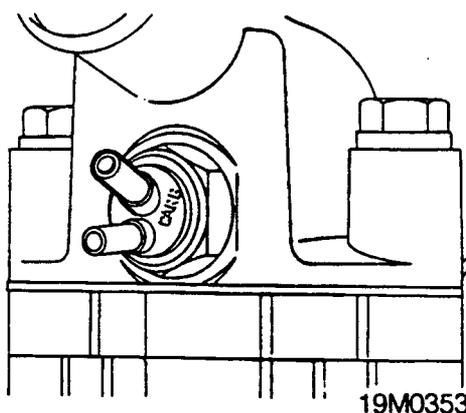

Note: The vacuum pipe from the carburetter connects to the angled connection marked 'CARB', on the switch.

6. Secure splash shield to rocker cover brackets.
7. Top up coolant level, see **MAINTENANCE**.

CHARCOAL CANISTER

Service Repair No. 17.15.13

Remove

1. Disconnect battery earth lead.
2. Remove air cleaner assembly, see **Air cleaner assembly**.
3. Release 2 turnbuckles securing splash shield to rocker cover brackets.

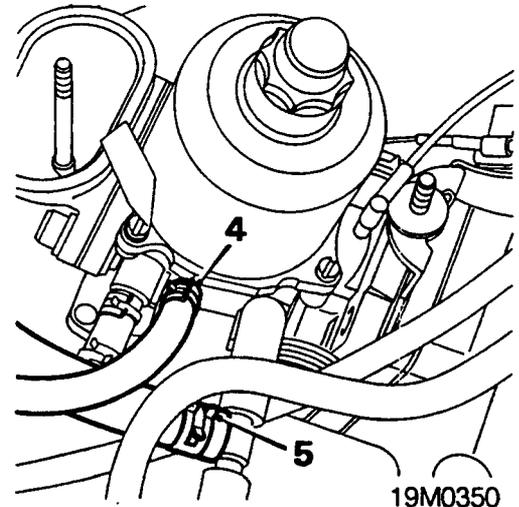

4. Release clip and disconnect hose from carburetter.
5. Release clip and disconnect hose from breather hose.
6. Disconnect vacuum pipe from distributor and thermal vacuum switch.

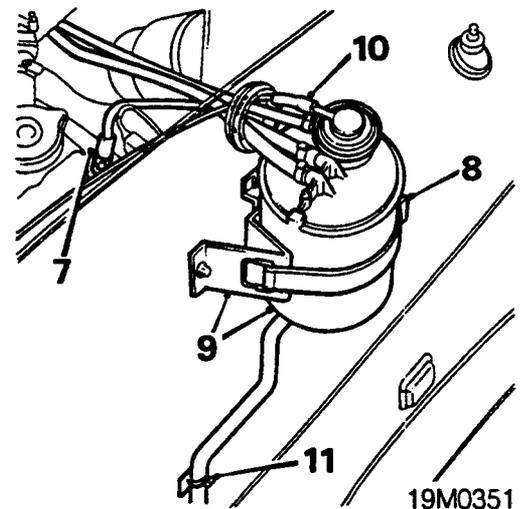

7. Release clip and disconnect hose from fuel return pipe.
8. Release strap securing charcoal canister to mounting bracket.
9. Release charcoal canister from mounting bracket.
10. Disconnect vacuum pipe from purge control valve.
11. Release canister vent hose from inner wing retaining clip.
12. Remove charcoal canister and purge control valve assembly.

CARBURETTER & IGNITION

Do not carry out further dismantling if component is removed for access only

13. Remove charcoal canister vent hose.
14. Remove hose retaining clips and remove hoses.

Refit

1. Fit hoses to charcoal canister and secure with clips.
2. Position charcoal canister and purge control valve assembly under wing.
3. Secure charcoal canister vent hose to clip on inner wing.
4. Connect vacuum pipe to purge control valve.
5. Feed hoses through hole in inner wing and fit charcoal canister to mounting bracket, secure with strap.
6. Connect hose to fuel return pipe and secure with clip.
7. Connect hose to carburetter and secure with clip.
8. Connect hose to breather hose and secure with clip.
9. Connect vacuum pipe to distributor and thermal vacuum switch.
10. Secure splash shield to rocker cover brackets.
11. Fit air cleaner assembly, see **Air cleaner assembly**.
12. Connect battery earth lead.

CONTENTS

Description and Operation	Page
MEMS - SPi	3
MEMS - SPi - operation	6
Catalyst equipped models	9

Adjustments	Page
Throttle cable adjustment	1

Repairs	Page
Fuel pressure test	1
Throttle cable	1
Charcoal canister	2
Purge control valve	2
Air temperature control valve	3
Thermac switch	3
Engine management ECU	4
Crankshaft sensor - manual gearbox models	4
Crankshaft sensor - automatic gearbox models	5
Intake air temperature sensor	5
Throttle potentiometer	6
Air cleaner assembly	6
Oxygen sensor	7
Throttle body	7
Injector housing	8
Manifold PTC heater	9
Fuel trap - ECU	9
Distributor	9
Relay module	10



MODULAR ENGINE MANAGEMENT SYSTEM-SPi

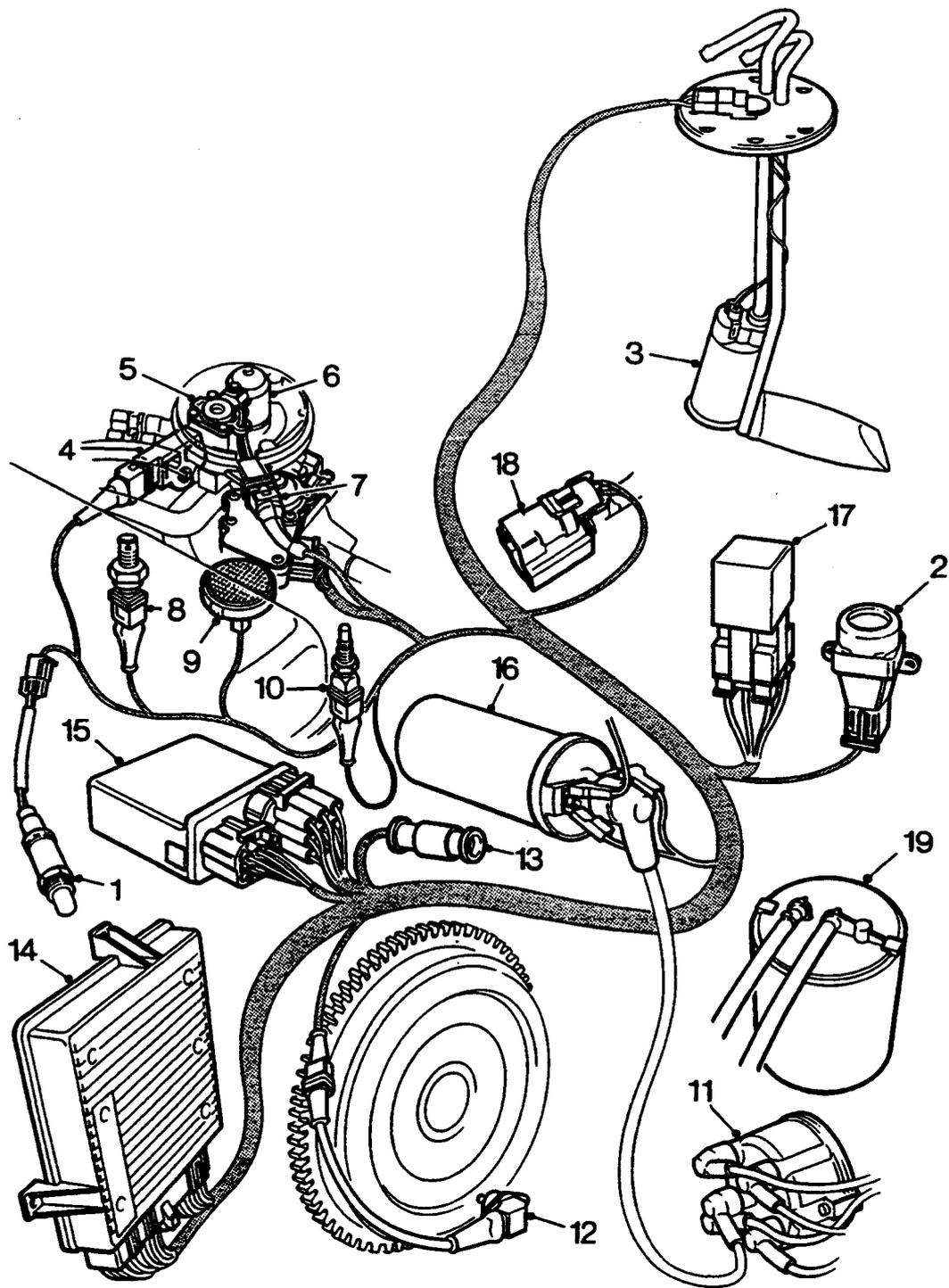

19M0167A



MEMS - SPI SYSTEM COMPONENTS

1. Oxygen sensor
2. Inertia switch
3. Fuel pump
4. Throttle potentiometer
5. Fuel pressure regulator
6. Injector
7. Stepper motor
8. Intake air temperature sensor
9. Manifold PTC heater
10. Coolant temperature sensor
11. Distributor
12. Crankshaft sensor
13. Diagnostic connector
14. ECU
15. Relay module
16. Ignition coil
17. Oxygen sensor relay
18. Purge valve
19. Charcoal canister

MODULAR ENGINE MANAGEMENT SYSTEM-SPi

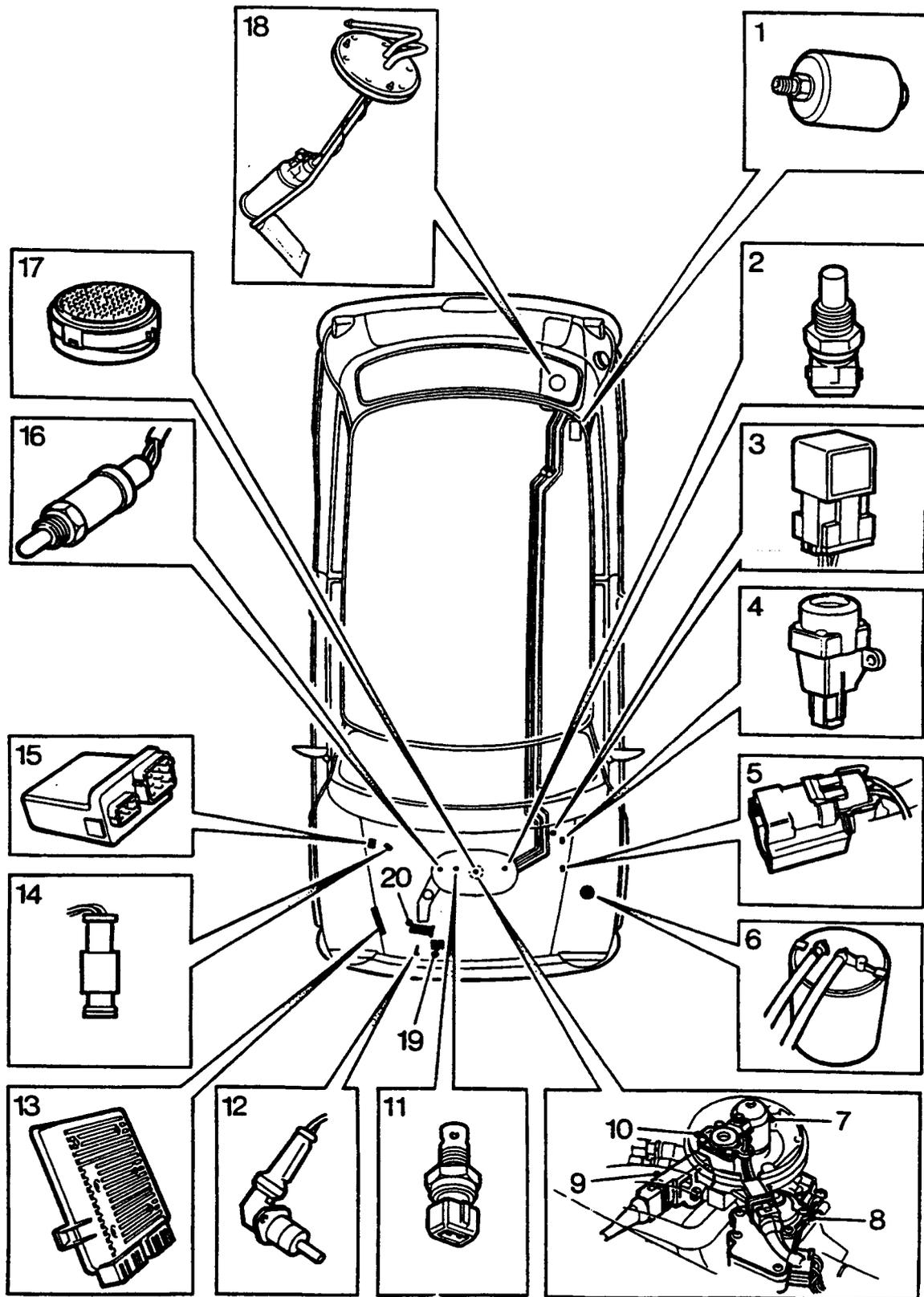

19M0168A



MEMS - SPi COMPONENT LOCATIONS

1. Fuel filter
2. Coolant temperature sensor
3. Oxygen sensor relay
4. Inertia switch
5. Purge control valve
6. Charcoal cannister
7. Injector
8. Stepper motor
9. Throttle potentiometer
10. Pressure regulator
11. Inlet air temperature sensor
12. Crankshaft sensor
13. ECU
14. Diagnostic connector
15. Relay module
16. Oxygen sensor
17. Inlet manifold PTC heater
18. Electric fuel pump

MODULAR ENGINE MANAGEMENT SYSTEM-SPI

MEMS - SPI - OPERATION

Ignition system

MEMS - SPI system incorporates a programmed ignition system in which the timing is controlled entirely by digital techniques within the ECU

Correct ignition timing is achieved by the ECU using signals received from the following:

Crankshaft sensor - crankshaft position and engine speed.

Manifold absolute pressure sensor - engine load.

Coolant temperature sensor - engine temperature.

MEMS uses no centrifugal or vacuum advance, timing being controlled by the ECU which is energised by the main relay within the relay module, with spark distribution being achieved by means of a rotor arm and distributor cap.

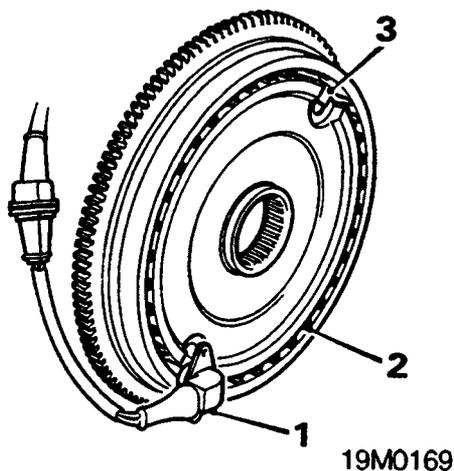

CRANKSHAFT SENSOR AND FLYWHEEL

1. Crankshaft sensor
2. Reluctor insert
3. Missing poles

Basic ignition timing

MEMS provides the optimum ignition timing for the relevant engine speed and load. The speed and position of the engine is detected by the crankshaft sensor which is bolted to, and projects through the flywheel housing.

The sensor incorporates an armature which runs adjacent to a reductor insert in the flywheel, the insert consisting of 34 poles spaced at 10° intervals, with two missing poles 180° apart to identify the TDC positions. The sensor 'reads' these poles to provide a constant up - date of engine speed and crankshaft position to the ECU.

The load signal is provided by the manifold absolute pressure sensor mounted inside the ECU casing which detects manifold pressure via a pipe and vapour trap connected to the inlet manifold. The sensor converts pressure variations into graduated electrical signals which can be read by the ECU.

Ignition timing compensation

Coolant temperature compensation.

The signal from the coolant temperature sensor allows the ECU to provide the optimum driveability at low engine and coolant temperatures by advancing or retarding the basic ignition timing.

Idle speed control.

When the throttle pedal is released the ECU uses the fast response of ignition advance to assist engine idle speed control.

When loads are placed on, or removed from the engine the ECU senses the change in engine speed and in conjunction with the opening of the throttle disc by the stepper motor, advances or retards the ignition timing to maintain the specified idle speed. When load is removed from the engine and the stepper motor returns to its original position, the ignition timing returns to the idle setting.

Note: Due to the sensitivity of this system the ignition timing will be constantly changing at idle speed.

Ignition components

Ignition coil.

Though similar in appearance to coils used in conventional ignition systems, the coil used in programmed ignition installations has a lower primary winding resistance (0.71 to 0.81 ohms at 20°C 68°F) than its conventional counterpart. This allows the full ht output to be reached faster and so makes the coil operation more consistent throughout the engine speed range.

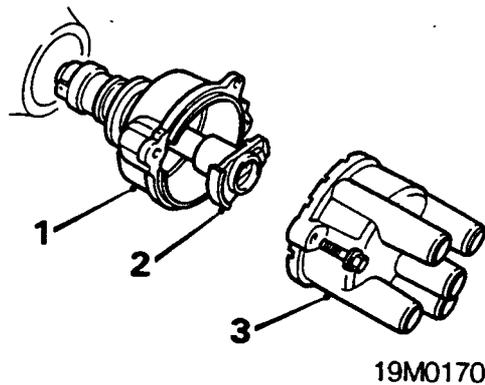

DISTRIBUTOR

1. Distributor body
2. Rotor arm
3. Distributor cap

Distributor cap and rotor arm.

The distributor cap, carrying a central carbon brush and four ht lead pick-ups, is located on a distributor body and surrounds the rotor arm. The rotor arm is mounted on the distributor shaft.

Fuel system

The MEMS Single Point injection system uses one injector mounted in a throttle body, the solenoid operated injector directing its spray onto the back of the throttle disc. The amount of fuel delivered is determined by the length of time the injector is held open, this being governed by the ECU in line with the inputs it receives.

The fuel delivery system is of the pressure recirculation type, pressure being created by an electric pump located inside the fuel tank and operated via the fuel pump relay within the relay module. From the pump fuel is delivered to the fuel filter where any impurities are removed. The fuel is pressurised around the injector housing against the pressure regulator, any excess pressure lifting the regulator and returning to the fuel tank.

The air intake system includes a stepper motor to control idle and fast idle speeds. An inlet manifold PTC heater controlled by the ECU via a relay within the relay module and an intake air temperature control system improve driveability during the warm-up period, and maintain intake air at the optimum temperature.

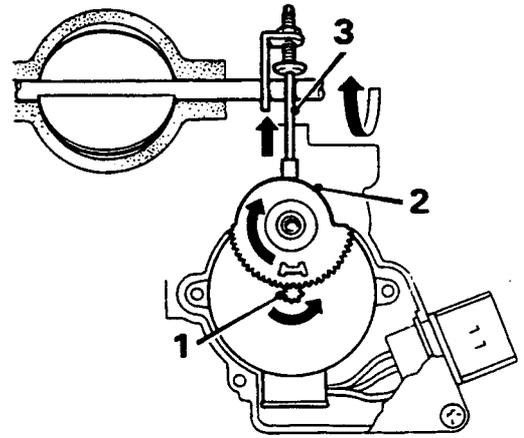

STEPPER MOTOR

19M0172

1. Stepper motor
2. Cam
3. Push rod

At idle air/fuel delivery to the engine is further refined by the partial opening of the throttle disc to compensate for variations in temperature and engine load, this is achieved using a stepper motor driven by the ECU which rotates a cam and push rod acting directly on the throttle spindle stop.

Calculation of air fuel ratio

The injector is a solenoid operated by the ECU which earths the solenoid coil once for each cylinder cycle (twice per crankshaft revolution) during normal driving conditions.

The amount of fuel injected is determined by how long the injector is held open (known as injector pulse width). To achieve the required air/fuel ratio the ECU receives signals from the following inputs:

- Crankshaft sensor - engine speed.
- Manifold absolute pressure - engine load.
- Inlet air temperature sensor - inlet air temperature.
- Coolant temperature sensor - engine temperature.
- Throttle potentiometer - rate of throttle opening.
- Battery voltage - state of battery charge.

Cruise air/fuel ratio.

The cruise air/fuel ratio is calculated by the speed/density method. Speed is determined by the crankshaft sensor and density (engine load) by the manifold absolute pressure and inlet air temperature sensors. The ECU contains the cruise air/fuel ratio in the form of a 2 dimensional map providing the required air/fuel ratio for 10 different engine speeds and 8 different inlet manifold density conditions.

The selection of air/fuel ratio is further refined by the ECU using the coolant temperature sensor, throttle potentiometer and battery voltage.

MODULAR ENGINE MANAGEMENT SYSTEM-SPi

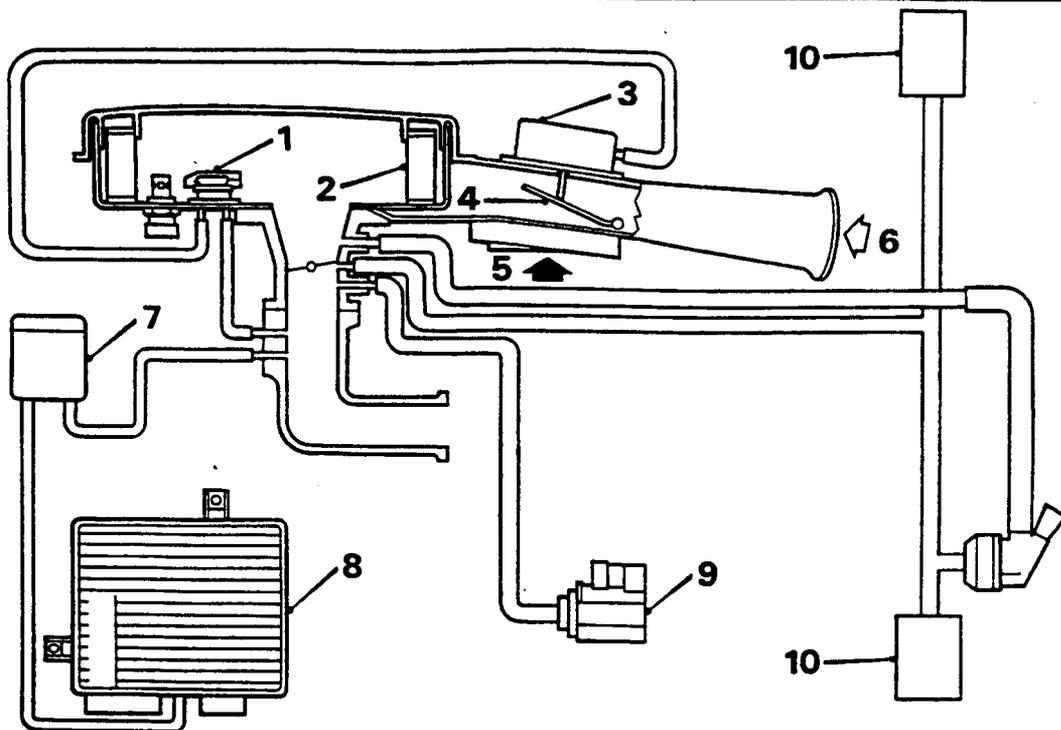

AIR INTAKE SYSTEM

19M0171

1. Thermac valve
2. Air filter
3. Vacuum servo
4. Flap
5. Air warmed by exhaust manifold
6. Cold air from front of vehicle

7. ECU Fuel trap
8. ECU
9. Purge control valve
10. Breather separator

Air intake system

Intake air passes via an intake air temperature control system and air filter into the throttle body. Incorporated in the throttle body are the injector, pressure regulator, throttle disc, stepper motor and throttle potentiometer. Good cold driveability is achieved by a coolant heated inlet manifold and PTC heater.

The intake air temperature control system relies on a vacuum servo, operated by a thermac valve, to divert intake air either over the exhaust manifold or direct from the front of the vehicle.

When cold the thermac valve remains closed allowing depression to draw up the servo so positioning a flap in the intake duct. This causes intake air to be drawn over the exhaust manifold, warming it before it passes to the air box.

As temperature increases the bi-metal strip in the thermac valve deforms, opening the valve and destroying the depression. The flap returns to its rest position as depression drops and causes cooler air to be drawn in direct from the front of the vehicle.

Inertia switch

The fuel pump circuit incorporates an inertia switch which in the event of a sudden deceleration isolates the power supply to the fuel pump. The inertia switch is situated in the engine compartment and can, if tripped, be reset by depressing the plunger.

WARNING: Check the integrity of the fuel system before the inertia switch is reset.

Diagnostic connector

A diagnostic connector is provided to enable diagnosis to be carried out without disturbing the system electrical connections and to allow the ECU's ability to store certain faults to be utilised.



CATALYST EQUIPPED MODELS

Closed – loop emission control

The MEMS SPi system operates a closed loop emission system to ensure the most efficient level of exhaust gas conversion.

An oxygen sensor fitted in the exhaust down pipe monitors the exhaust gases. It then supplies a small voltage proportional to exhaust oxygen content to the engine management ECU. As the air/fuel mixture weakens, the exhaust oxygen content increases and so the voltage to the ECU increases. If the mixture becomes richer so the oxygen content decreases and with it the voltage.

The ECU uses this signal voltage to determine the air/fuel mixture being delivered to the engine, and adjusts the injector duration to maintain the ratio necessary for efficient gas conversion by the catalyst.

The oxygen sensor has an integral heating element to ensure an efficient operating temperature is quickly reached from cold. The electrical supply for the heater element is controlled by the oxygen sensor relay.

Non – evaporative loss equipment

Charcoal canister

A charcoal canister is used for the temporary storage of fuel vapour from the fuel tank until the vapour can be purged from the canister into the engine and burned.

The charcoal canister is purged when the purge control valve is open, fresh air is drawn through the purge air hose, through the charcoal canister and into a port in the throttle housing.

Purge control valve

A purge control valve is operated by the Engine Management ECU. The valve remains closed when the engine is cold and at idling speed to protect engine tune and catalyst performance. When the engine is above 70°C, the purge valve solenoid will be modulated ON and OFF whenever the engine speed is above 1500 rev/min and the manifold absolute pressure is below 30 kpa. When the purge valve is opened, fuel vapour from the charcoal canister is drawn into the throttle housing for combustion.



THROTTLE CABLE ADJUSTMENT

1. Switch on ignition.
2. Open and close throttle fully, using throttle cam, to position stepper motor.

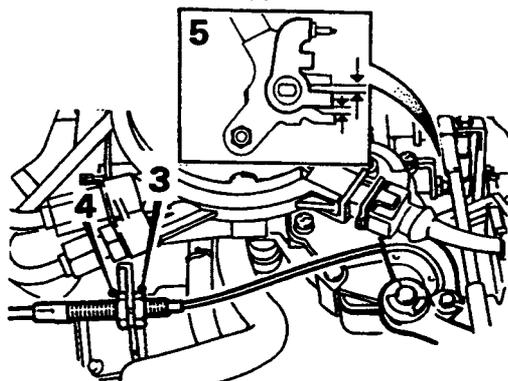

19M0174

3. Slacken cable locknut from abutment bracket.
4. Slacken cable adjusting nut from abutment bracket.
5. Tighten adjusting nut to tension throttle cable until an equal gap is obtained on each side of throttle lever.
6. Tighten locknut to contact abutment bracket.
7. Using two spanners tighten nuts against abutment bracket.
8. Ensure gap is still equal each side of throttle lever.



FUEL PRESSURE TEST

Service Repair No. 19.50.13

1. Ensure ignition is switched off.
2. Disconnect battery earth lead.
3. Position absorbant cloth around fuel feed hose to pipe connection.

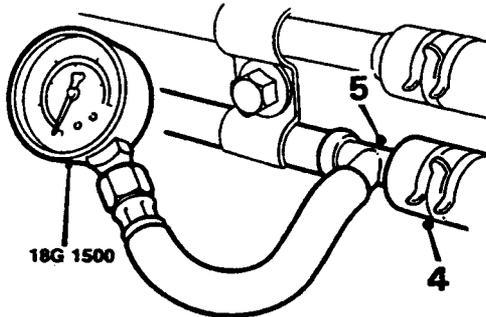

19M0178

4. Release clip and disconnect fuel feed hose from pipe.
5. Connect pressure gauge 18G 1500 between fuel feed hose and pipe.
6. Connect battery earth lead.
7. Start engine. Pressure should reach 1.0 bar.
8. Stop engine. Pressure drop should not exceed 0.7 bar in first minute.
9. If figures given in 3 and 4 not achieved, check for leaks. If no leaks found, renew regulator valve assembly.

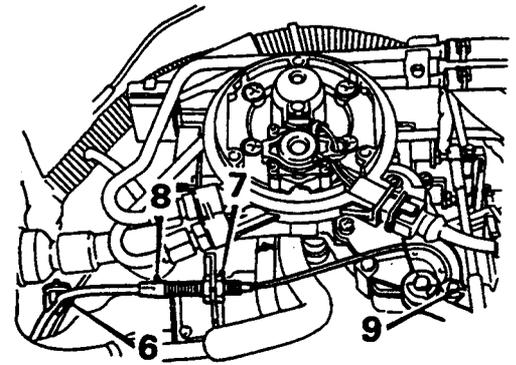

19M0176

6. Release throttle outer cable from clip on servo bracket.
7. Slacken outer cable locknut.
8. Release cable from abutment bracket
9. Disconnect inner cable from cam.

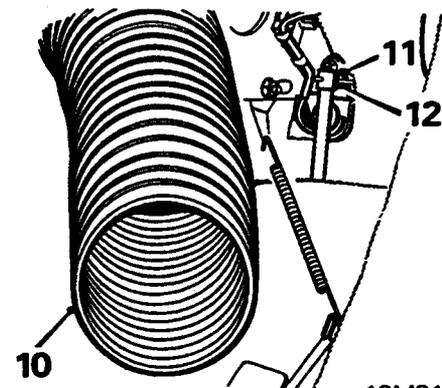

19M0177

10. Release heater air intake duct from adaptor inside vehicle, move duct aside.
11. Remove clip securing throttle inner cable to pedal.
12. Release inner cable from pedal.
13. Remove cable

THROTTLE CABLE

Service Repair No. 19.20.06

Remove

1. Remove air cleaner assembly.

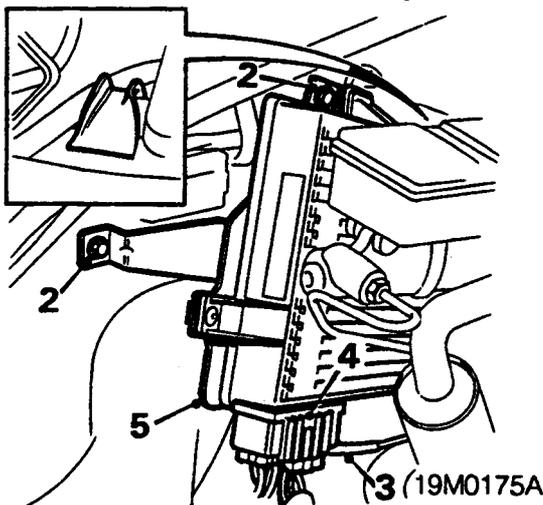

2. Remove 2 screws, ECU to valance.
3. Disconnect vacuum pipe from ECU.
4. Disconnect multiplug from ECU.
5. Remove ECU

Refit

1. Fit cable through bulkhead, fit inner cable to pedal and fit clip.
2. Connect heater intake duct to adaptor.
3. Connect multiplug and vacuum pipe to ECU.
4. Fit ECU, fit and tighten screws.
5. Connect throttle inner cable to throttle cam.
6. Fit cable to abutment bracket and to clip on servo bracket.
7. Check/adjust throttle cable, see **Adjustments**.
8. Fit air cleaner assembly.

MODULAR ENGINE MANAGEMENT SYSTEM-SPi

CHARCOAL CANISTER

Service Repair No. 17.15.13

Remove

1. Disconnect battery earth lead.
2. Raise front LH side of vehicle.

WARNING: Support on safety stands.

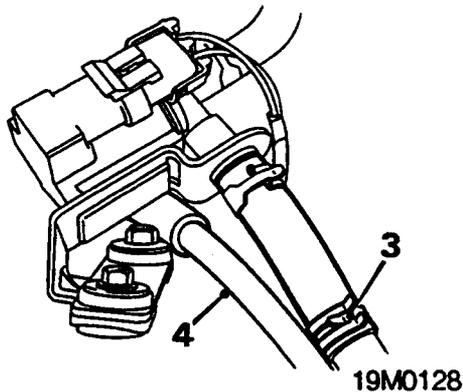

3. Release clip, disconnect purge hose from pipe.
4. Disconnect hose from fuel tank pipe.

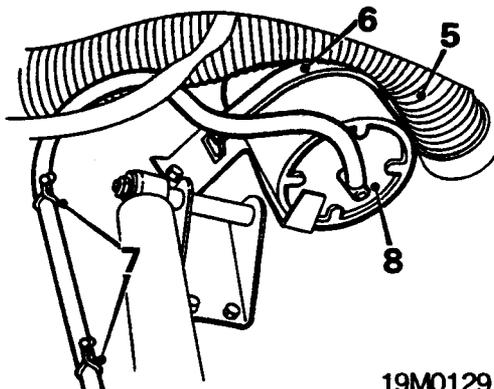

5. Disconnect fresh air intake duct, move aside for access.
6. Release and remove charcoal canister strap.
7. Release charcoal canister drain hose from clips.
8. Remove charcoal canister and hose.

Refit

1. Fit charcoal canister to bracket, secure with strap.
2. Fit drain hose to clips.
3. Connect fresh air intake duct.
4. Connect hose to fuel tank pipe.
5. Connect purge hose to pipe, secure clip.
6. Remove stand(s) and lower vehicle.
7. Connect battery earth lead.

PURGE CONTROL VALVE

Service Repair No. 17.15.39

Remove

1. Disconnect battery earth lead.

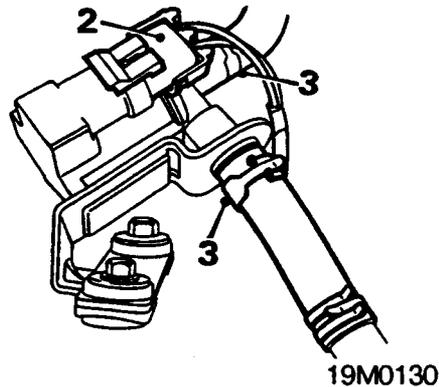

2. Disconnect purge valve multiplug.
3. Release clips and disconnect hoses from purge valve.

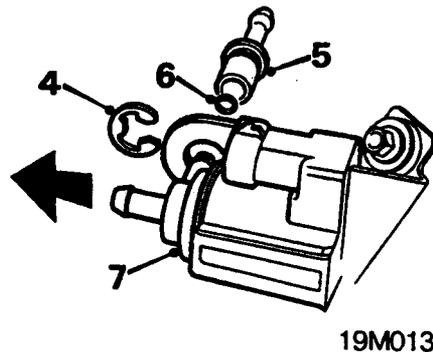

4. Remove 'C' clip, hose adaptor to purge valve.
5. Remove hose adaptor.
6. Remove 'O' ring.
7. Remove purge valve from bracket.

Refit

1. Fit purge valve to bracket.
2. Fit 'O' ring to hose adaptor.
3. Fit hose adaptor to purge valve.
4. Fit 'C' clip.
5. Connect hoses to purge valve, lower hose is from charcoal canister.
6. Secure hose clips.
7. Connect multiplug.
8. Connect battery earth lead.



AIR TEMPERATURE CONTROL VALVE

Service Repair No. 17.30.03

Remove

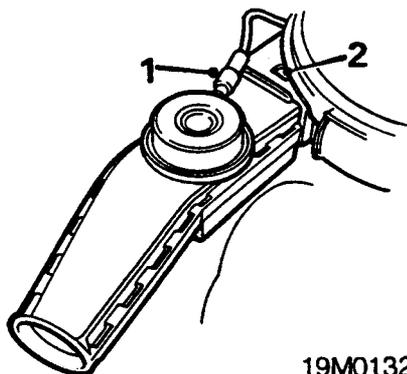

19M0132

1. Disconnect vacuum pipe from air temperature control valve.
2. Release intake duct from air cleaner, remove intake duct.

Refit

1. Fit intake duct to air cleaner.
2. Connect vacuum pipe to air temperature control valve.

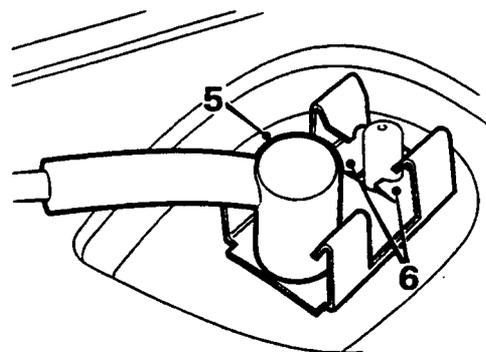

19M0134

5. Disconnect vacuum pipe from switch.
6. Bend up tags on switch clip and remove clip.

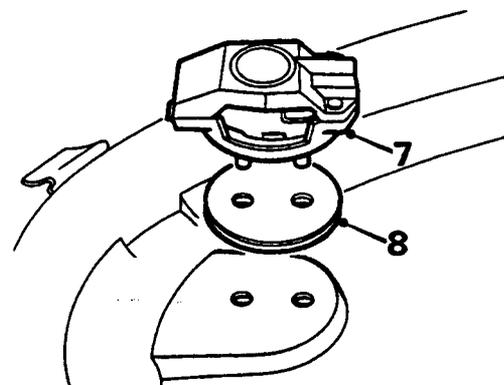

19M0135

7. Remove switch.
8. Remove seal.

THERMAC SWITCH

Service Repair No. 17.30.10

Remove

1. Disconnect battery earth lead.
2. Remove air cleaner assembly.

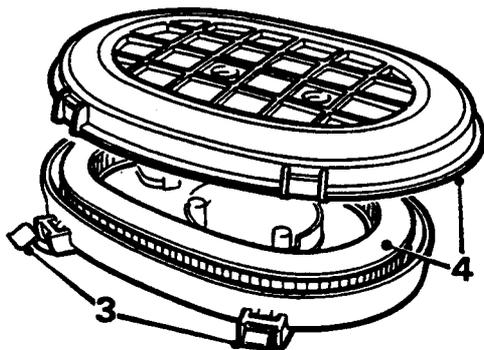

19M0133

3. Release clips securing air cleaner lid.
4. Remove lid and filter element.

Refit

1. Clean switch and mating face.
2. Fit seal and switch and secure with clip.
3. Connect vacuum pipe
4. Clean inside of air cleaner case and fit air cleaner element.
5. Fit air cleaner lid and secure clips.
6. Fit air cleaner assembly.
7. Connect battery earth lead.

MODULAR ENGINE MANAGEMENT SYSTEM-SPI

ENGINE MANAGEMENT ECU

Service Repair No. 18.30.01

Remove

1. Disconnect battery earth lead.

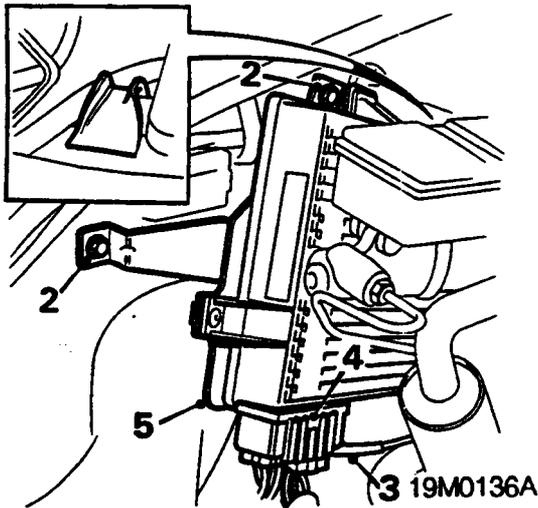

2. Remove 2 screws, ECU bracket to valance.
3. Disconnect vacuum pipe from ECU.
4. Disconnect multiplug from ECU.
5. Remove ECU and bracket.

Do not carry out further dismantling if component is removed for access only

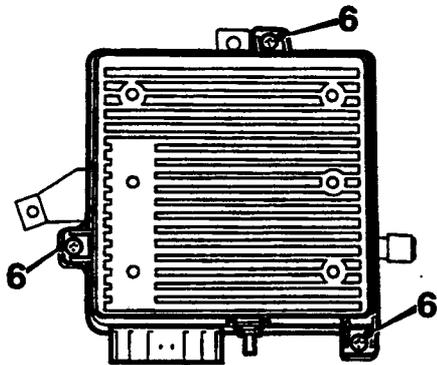

6. Remove 3 screws, ECU to bracket.
7. Remove bracket

Refit

1. Fit bracket to ECU, fit and tighten screws.
2. Connect multiplug to ECU.
3. Connect vacuum pipe to ECU.
4. Fit ECU and bracket to valance, fit and tighten screws.
5. Connect battery earth lead.

CRANKSHAFT SENSOR - MANUAL GEARBOX MODELS

Service Repair No. 18.30.12

Remove

1. Disconnect battery earth lead.
2. Raise front of vehicle.

WARNING: Support on safety stands.

3. Remove front grille.

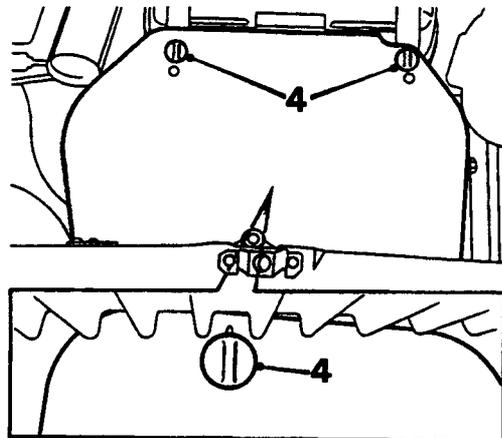

19M0139

4. Release 3 fasteners and remove ignition shield.

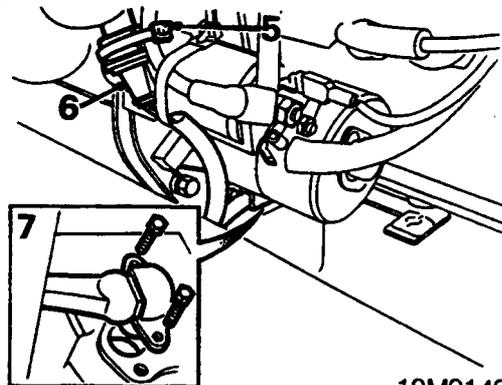

19M0140

5. Remove tie, crankshaft sensor lead to starter solenoid.
6. Disconnect crankshaft sensor multiplug.
7. Remove 2 screws, crankshaft sensor to flywheel housing.
8. Remove crankshaft sensor.

Refit

1. Clean crankshaft sensor and mating face.
2. Fit crankshaft sensor.
3. Fit screws and tighten to 6 Nm.
4. Connect multiplug.
5. Fit tie, crankshaft sensor lead to solenoid.
6. Fit ignition shield and secure fasteners.
7. Fit front grille.
8. Remove stand(s) and lower vehicle.
9. Connect battery earth lead.



CRANKSHAFT SENSOR - AUTOMATIC GEARBOX MODELS

Service Repair No. 18.30.12

Remove

1. Disconnect battery earth lead.

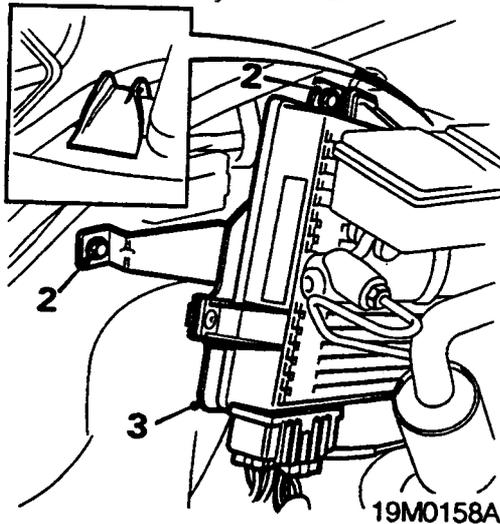

2. Remove 2 screws, ECU bracket to valance.
3. Release bracket from clip and move ECU and bracket aside.

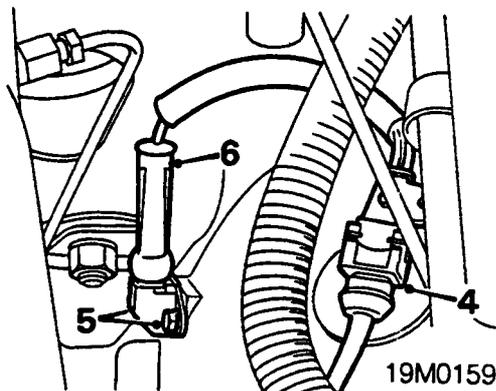

4. Disconnect crankshaft sensor multiplug.
5. Remove 2 screws, crankshaft sensor to torque converter cover.
6. Remove crankshaft sensor.

Refit

1. Clean crankshaft sensor and mating face.
2. Fit crankshaft sensor.
3. Fit screws and tighten to 6 Nm.
4. Connect battery earth lead.
5. Fit ECU and bracket to valance, fit and tighten screws.

INTAKE AIR TEMPERATURE SENSOR

Service Repair No. 18.30.09

Remove

1. Remove air cleaner assembly.

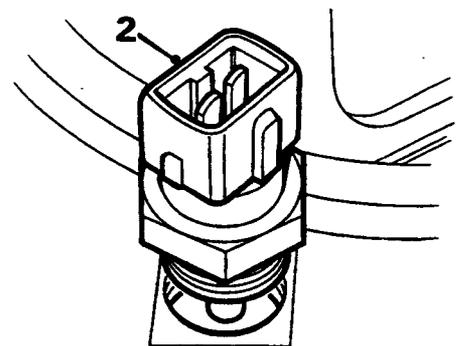

2. Remove air temperature sensor.

Refit

1. Fit air temperature sensor and tighten to 7 Nm.
2. Fit air cleaner assembly.

MODULAR ENGINE MANAGEMENT SYSTEM-SPi

THROTTLE POTENTIOMETER

Service Repair No. 18.30.17.

Remove

1. Disconnect battery earth lead.
2. Remove air cleaner assembly.

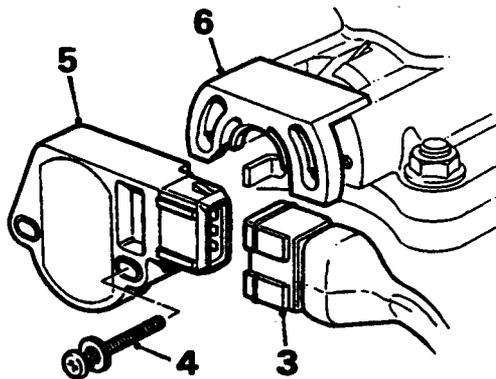

3. Disconnect throttle potentiometer multiplug.
4. Remove 2 screws securing throttle potentiometer.
5. Remove throttle potentiometer.
6. Remove spacer.

Refit

1. Clean spacer and mating faces, fit spacer.
2. Fit and align throttle potentiometer to throttle body.
3. Apply loctite to screws, fit and tighten screws.
4. Rotate throttle cam, check potentiometer lever action, ensure lever is inside throttle lever.
5. Connect multiplug.
6. Fit air cleaner assembly.
7. Connect battery earth lead.

AIR CLEANER ASSEMBLY

Service Repair No. 19.10.01

Remove

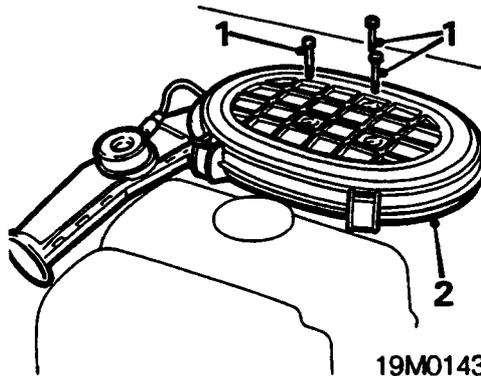

1. Remove 3 screws, air cleaner to throttle body.
2. Lift air cleaner.

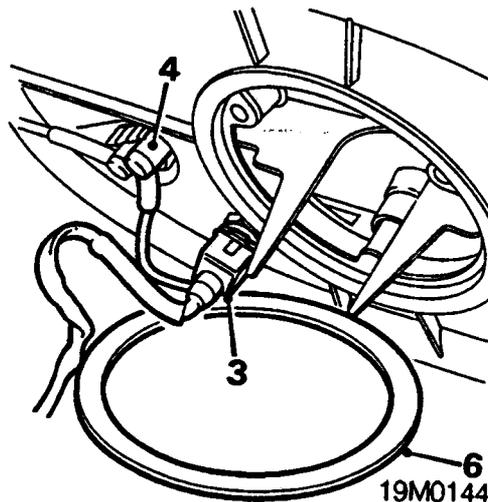

3. Disconnect air temperature sensor multiplug.
4. Disconnect vacuum pipe.
5. Remove air cleaner.
6. Remove seal.

Refit

1. Clean mating faces and fit seal to throttle body.
2. Fit air cleaner
3. Connect vacuum pipe.
4. Connect multiplug.
5. Position air cleaner correctly, fit and tighten screws.



OXYGEN SENSOR

Service Repair No. 19.22.16

Remove

1. Remove inlet manifold, see **MANIFOLD & EXHAUST - Repairs**.

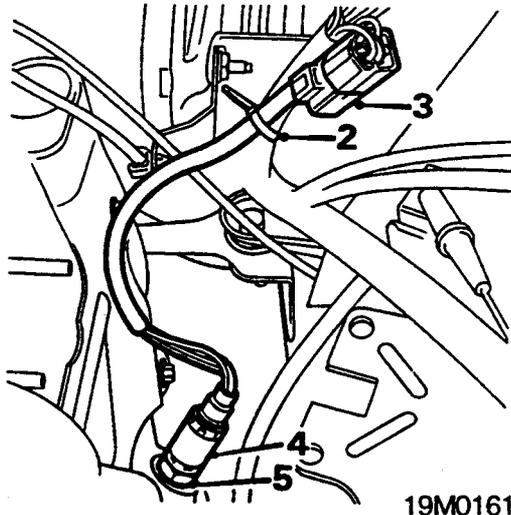

2. Remove tie securing oxygen sensor lead to engine harness.
3. Disconnect oxygen sensor multiplug.
4. Remove oxygen sensor.
5. Remove sealing washer.

Refit

1. Clean and fit sealing washer to sensor.
2. Apply Never Seez to sensor thread.
3. Fit sensor and tighten to 55 Nm.
4. Connect multiplug.
5. Fit tie to secure oxygen sensor lead to engine harness.
6. Fit inlet manifold, see **MANIFOLD & EXHAUST - Repairs**.

THROTTLE BODY

Service Repair No. 19.22.45.

Remove

1. Disconnect battery earth lead.
2. Remove air cleaner assembly.

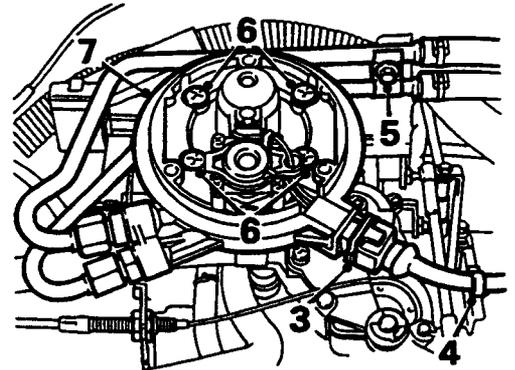

19M0162

3. Disconnect injector multiplug.
4. Release injector multiplug harness from clip.
5. Remove screw from fuel pipe clip and remove clip.
6. Remove 4 screws, injector housing to throttle body.
7. Lift injector housing and move aside.

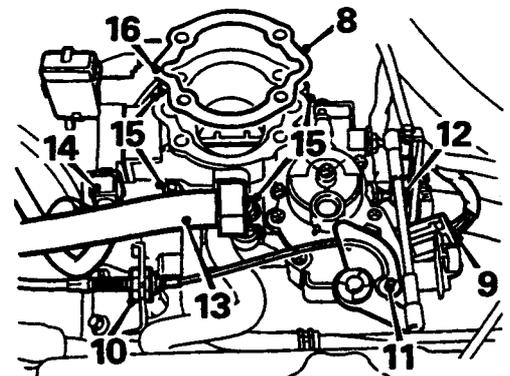

19M0163

8. Remove gasket
9. Disconnect stepper motor multiplug.
10. Release throttle cable from abutment bracket.
11. Disconnect throttle inner cable from cam.
12. *Automatic gearbox models:* Disconnect down shift rod from throttle lever.
13. Disconnect breather hose from throttle body.
14. Disconnect throttle potentiometer multiplug.
15. Remove 4 nuts securing throttle body
16. Lift fuel pipe bracket from manifold studs.
17. Lift throttle body from manifold studs.

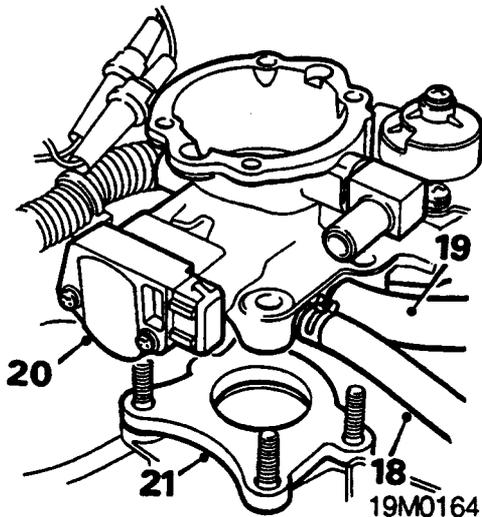

18. Release clip and disconnect purge hose.
19. Disconnect breather hose.
20. Remove throttle body.
21. Remove spacer.

Refit

1. Clean mating faces and fit throttle body spacer.
2. Connect breather hose.
3. Connect purge hose and secure clip.
4. Fit throttle body and fuel pipe bracket to manifold studs.
5. Fit throttle body nuts and tighten to 10 Nm.
6. Connect throttle potentiometer multiplug.
7. Connect breather hose to throttle body.
8. *Automatic gearbox models:* Connect down shift rod to throttle lever.
9. Connect throttle inner cable to cam.
10. Secure throttle cable in abutment bracket.
11. Check/adjust throttle cable, see **Adjustments**.

12. Connect stepper motor multiplug.
13. Clean injector housing and throttle body mating faces.
14. Fit injector housing and gasket.
15. Apply Loctite Screwlock or Nutlock to injector housing screw threads.
16. Fit injector housing screws and tighten to 5 Nm.
17. Fit fuel pipe clip and tighten screw.
18. Connect injector multiplug and secure harness with clip.
19. Fit air cleaner assembly.
20. Connect battery earth lead.

INJECTOR HOUSING

Service Repair No. 19.22.61.

Remove

1. Disconnect battery earth lead.
2. Remove air cleaner assembly.

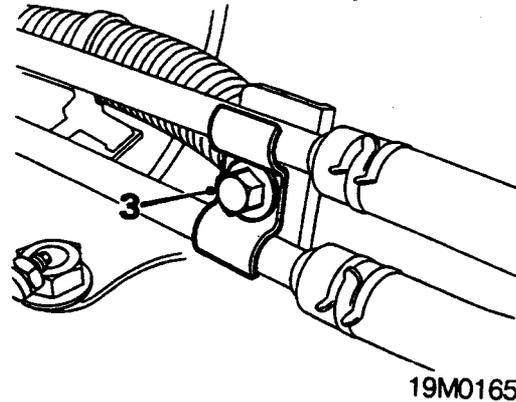

3. Remove screw from fuel pipe clip and remove clip.
4. Position absorbent cloth under fuel feed and return pipe unions. Examine pipe connections for signs of leakage.

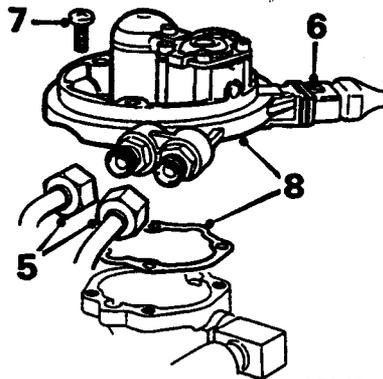

5. Use backing spanner and unscrew 2 unions, plug pipes and remove cloth.
6. Disconnect injector multiplug.
7. Remove 4 screws, injector housing to throttle body.
8. Remove injector housing and gasket.

Refit

1. If leakage has been detected:
From union; examine sealing surfaces on pipe unions and adaptors for signs of damage, renew parts as necessary.
From adaptor; unscrew adaptor one turn and then two turns byhand, if threads are tight renew housing. Fit new sealing washers to adaptors and tighten to 24 Nm.
2. Clean injector housing and throttle body mating faces.
3. Fit injector housing and gasket.
4. Apply Loctite Screwlock or Nutlock to injector housing screw threads.
5. Fit injector housing screws and tighten to 5 Nm.



6. Remove plugs from fuel pipes and clean unions.
7. Connect pipes and tighten unions finger tight.
8. DO NOT use backing spanner, tighten fuel pipe unions to 24 Nm.
9. Fit fuel pipe clip and tighten screw.
10. Connect multiplug.
11. Fit air cleaner assembly.
12. Connect battery earth lead.

MANIFOLD PTC HEATER

Service Repair No. 30.15.34

Remove

1. Remove inlet manifold, see **MANIFOLD & EXHAUST - Repairs.**

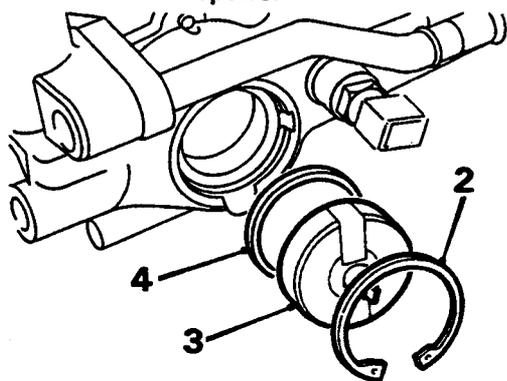

19M0584

2. Remove circlip securing heater to inlet manifold.
3. Remove heater.
4. Remove and discard rubber seal from heater.

Refit

1. Clean inlet manifold and heater mating faces.
2. Fit new rubber seal to heater and position heater to inlet manifold.
3. Secure heater in place with circlip.
4. Refit inlet manifold, see **MANIFOLD & EXHAUST - Repairs.**

FUEL TRAP - ECU

Service Repair No. 19.25.10

Remove

1. Disconnect battery earth lead.
2. Remove air cleaner assembly.

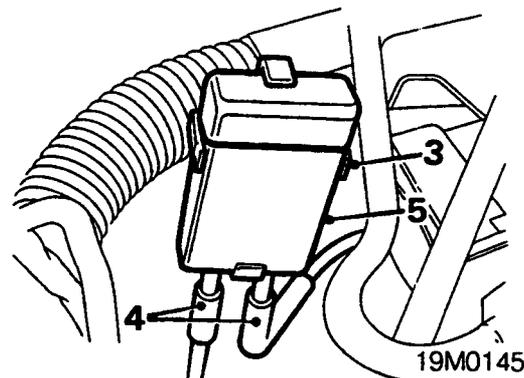

19M0145

3. Release fuel trap from clip.
4. Disconnect 2 vacuum pipes
5. Remove fuel trap.

Refit

1. Connect 2 vacuum pipes.
2. Fit fuel trap to clip.
3. Fit air cleaner assembly.
4. Connect battery earth lead.

DISTRIBUTOR

Service Repair No. 18.20.20

Remove

1. Disconnect battery earth lead.
2. Release 3 fasteners (2 on automatic gearbox models) and remove ignition shield.
3. Remove rocker cover.
4. Rotate crankshaft to position No. 1 piston at TDC compression.

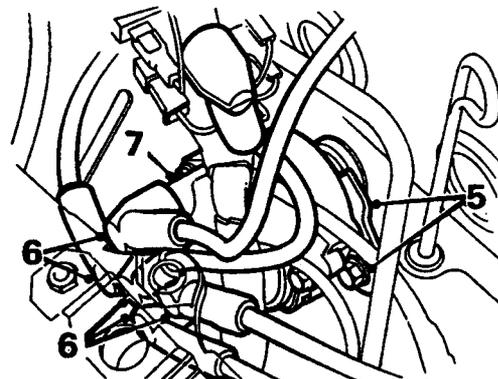

19M0156

5. Slacken distributor clamp bolt and slide clamp off distributor flange.
6. Note their positions and disconnect ht leads from distributor cap.
7. Withdraw distributor.

MODULAR ENGINE MANAGEMENT SYSTEM-SPI

Refit

1. Ensure No. 1 piston is at TDC compression.
2. Remove distributor cap.
3. Fit distributor, ensuring that distributor drive dog engages slot in distributor drive shaft.

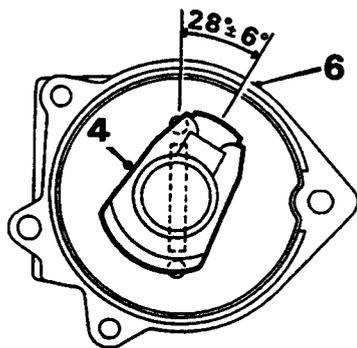

19M0157

4. Check that rotor arm is at angular position shown. If rotor arm position is incorrect, remove distributor and reposition distributor drive shaft.
5. Move distributor clamp onto distributor flange but do not tighten bolt.
6. Rotate distributor body to position shown in relation to rotor arm.
7. Tighten distributor clamp bolt.
8. Fit distributor cap.
9. Connect ht leads.
10. Fit rocker cover.
11. Fit ignition shield.
12. Connect battery earth lead.

RELAY MODULE

Service Repair No. 18.30.71

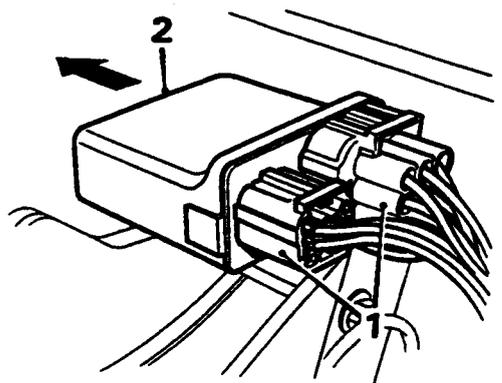

19M0173

Remove

1. Disconnect 2 multiplugs from relay module.
2. Release and remove module from bracket.

Refit

1. Fit relay module to bracket.
2. Connect multiplugs.

FUEL DELIVERY SYSTEM

CONTENTS

Description and Operation

	Page
System operation - Carburettor models	2
System operation - SPi models	3

Repairs

	Page
Fuel tank draining - SPi models	1
Fuel tank - Carburettor models	1
Fuel tank - SPi models	3
Inertia switch - SPi models	4
Fuel pump - SPi models	5
Fuel tank breather two-way valve	5



FUEL DELIVERY SYSTEM

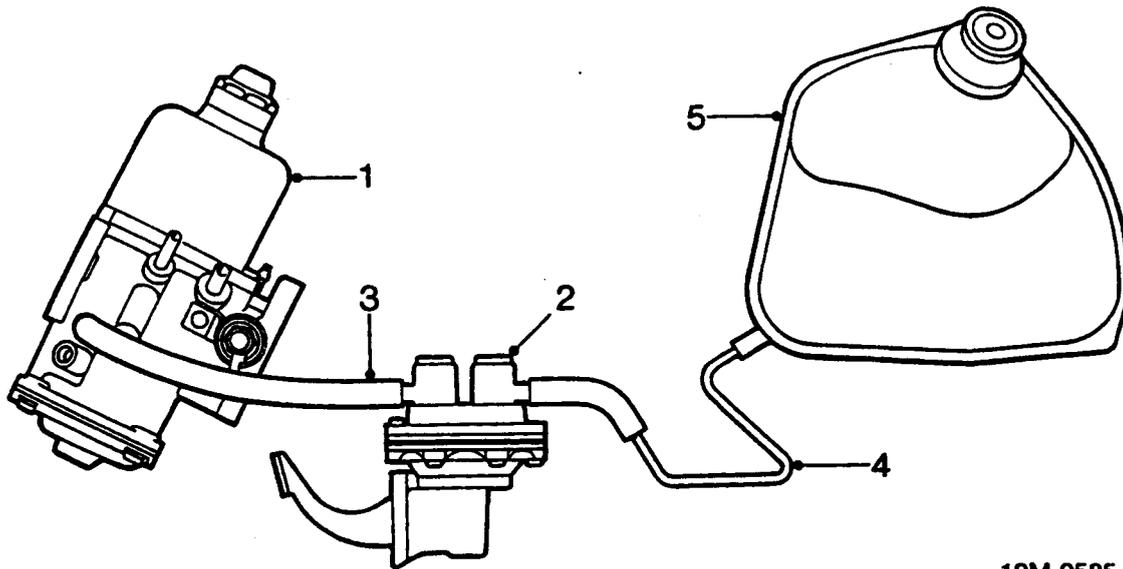

19M 0585

Fuel system components - Carburettor models

1. Carburettor
2. Fuel pump
3. Feed line
4. Fuel pick - up
5. Fuel tank

SYSTEM OPERATION - CARBURETTOR MODELS

Fuel is drawn from the fuel tank via an under - body fuel line by a mechanical fuel pump, mounted on the engine cylinder block and driven by the camshaft. The pump supplies fuel direct to the carburettor float chamber.

Fuel tank breathing is via a two - way valve fitted to the filler neck with the pipe routed via the underside of the vehicle to the charcoal canister located under LH front wing.

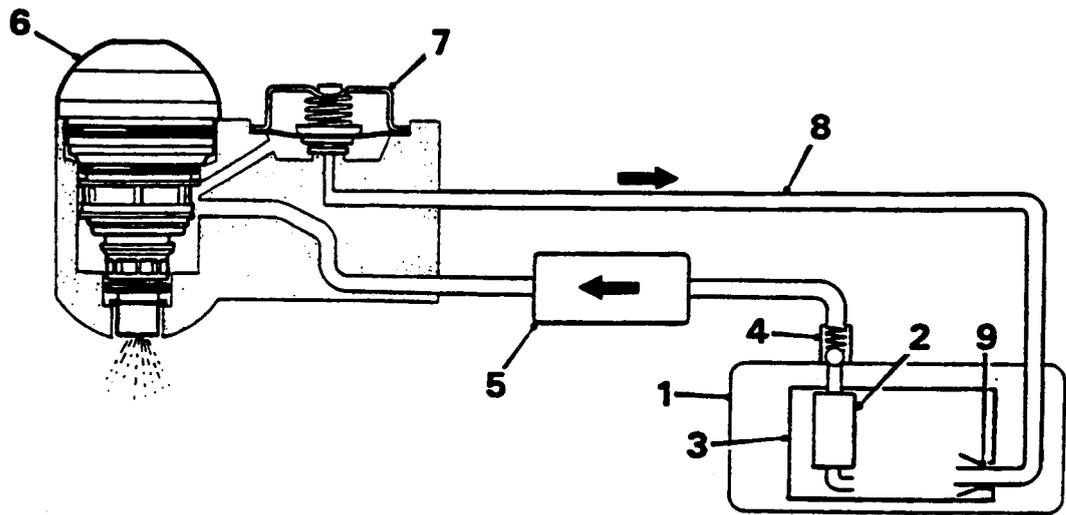

19M0586

Fuel system components - SPI models

- | | |
|---|---|
| <ul style="list-style-type: none"> 1. Fuel tank 2. Fuel pump 3. Swirl pot 4. Non return valve 5. Fuel filter | <ul style="list-style-type: none"> 6. Injector 7. Fuel pressure regulator 8. Return line 9. Venturi |
|---|---|

SYSTEM OPERATION - SPI MODELS

Fuel is lifted from the fuel tank by an immersed electric pump, operating in a swirl pot which allows a constant fuel level to be maintained around the pump pick-up.

Pressurised fuel is fed via a non return valve which prevents fuel returning to the tank when the pump is not running, to an in-line fuel filter.

From the filter fuel is delivered to the injector. Fuel pressure is controlled by the regulator, any excess fuel flowing via the return line to the swirl pot where a venturi causes returning fuel to draw cool fuel in from the tank.

Inertia switch

The fuel pump circuit incorporates an inertia switch which, in the event of a sudden deceleration, isolates the power supply to the fuel pump. The inertia switch is situated on the bulkhead in the left-hand side of the engine compartment and can, if tripped, be reset by depressing the top.

WARNING: Check the integrity of the fuel system before the inertia switch is reset.



FUEL TANK DRAINING - SPI MODELS

WARNING: Before removing the fuel tank from the vehicle it must be drained.

1. Disconnect battery earth lead.

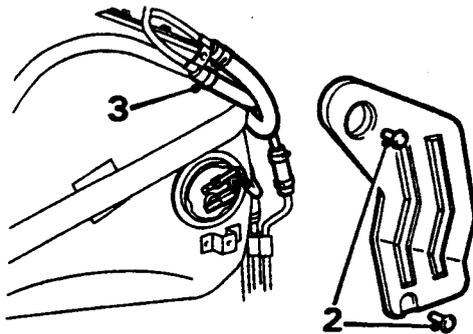

19M0146

2. Remove 2 studs, protection cover to side of fuel tank.

Note: The fuel feed hose is marked with a yellow band, the return hose is unmarked.

3. Release clip, disconnect fuel return hose, plug hose.
4. Connect drain hose to fuel return pipe. Drain hose must be long enough to reach outside vehicle and hang lower than bottom of tank.
5. Connect drain hose to Mityvac pump via a fuel trap.
6. Create vacuum with Mityvac to start siphoning action, siphon fuel into a sealed container.
7. Continue siphoning until air bubbles appear and fuel ceases to flow.
8. Disconnect drain hose from fuel return pipe.

FUEL TANK - CARBURETTER MODELS

Service Repair No. 19.55.01

Remove

1. Remove spare wheel and cover from luggage compartment.
2. Disconnect battery earth lead.
3. Using a bowser, drain fuel from the fuel tank until air bubbles appear and fuel ceases to flow, see **INFORMATION - GENERAL DATA - Fuel Handling Precautions.**

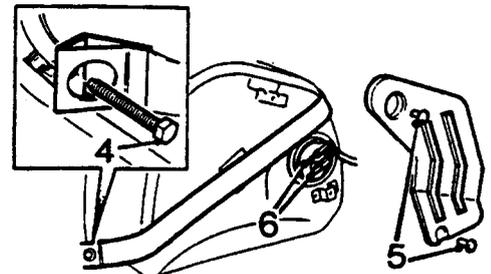

19M 0587

4. Remove bolt securing fuel tank strap to body.
5. Remove 2 studs securing cover to fuel tank and remove cover.
6. Disconnect 2 Lucars from fuel gauge sender unit.

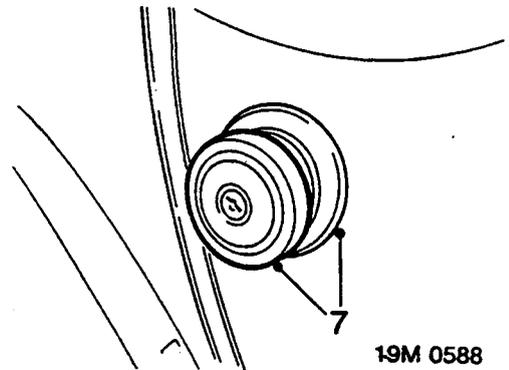

19M 0588

7. Remove fuel filler cap and seal from filler neck.

FUEL DELIVERY SYSTEM

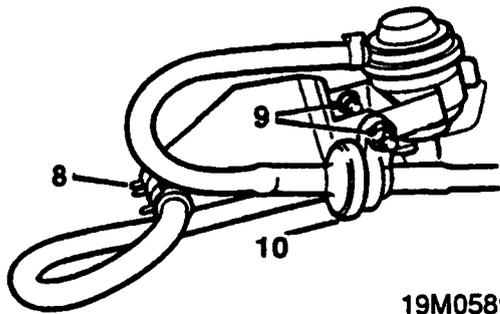

19M0589

8. Release clip and disconnect hose from two-way breather valve to tank.
9. Remove nut securing two-way breather valve to fuel tank.
10. Release two-way breather valve from fuel tank.

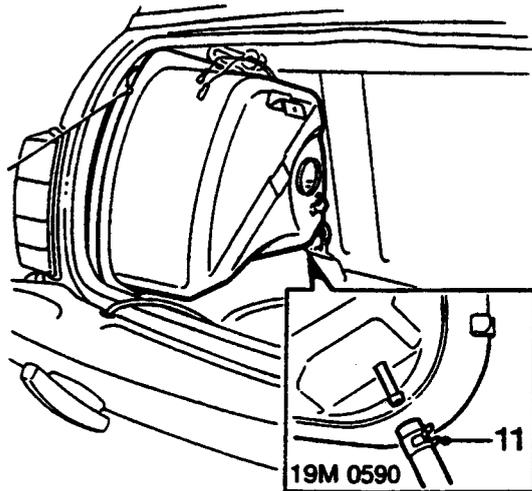

19M0590

11. Release clip securing fuel hose to rear of fuel tank and disconnect hose.

CAUTION: Position absorbent cloth to collect fuel spillage.

12. Release fuel tank from body and manoeuvre to centre of luggage compartment.
13. Release two way breather pipe from clips on rear of fuel tank.
14. Carefully remove fuel tank from luggage compartment.

Do not carry out further dismantling if component is removed for access only

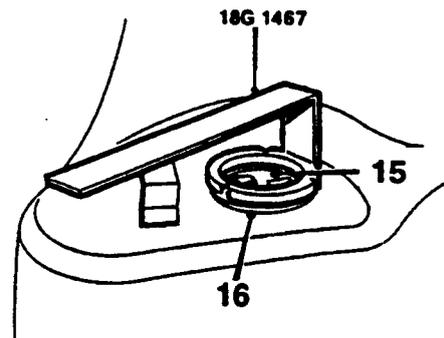

19M0591

15. Remove fuel gauge sender unit, using tool 18G 1467.
16. Remove seal.
17. Clean mating faces of fuel tank and sender unit.
18. Fit seal to fuel gauge sender unit, position to tank and tighten in position using tool 18G 1467.

Refit

1. Carefully manoeuvre fuel tank in luggage compartment.
2. Connect fuel hose to tank and secure with clips.
3. Secure two-way breather valve to clips on tank.
4. Position fuel tank in luggage compartment.
5. Fit filler neck seal.
6. Fit two-way breather valve and tighten retaining nut.
7. Connect two-way breather valve hose to fuel tank and secure with clip.
8. Connect 2 Lucars to fuel gauge sender unit.
9. Position strap around fuel tank and tighten bolt to hold tank securely in place.
10. Fit cover to fuel tank and secure with studs.
11. Fill fuel tank and refit filler cap.
12. Connect battery earth lead.
13. Fit spare wheel and cover.



FUEL TANK - SPi MODELS

Service Repair No. 19.55.01

Remove

1. Disconnect battery earth lead.
2. Remove spare wheel cover.
3. Drain fuel tank, see **Fuel tank draining - SPi models.**
4. Remove spare wheel.

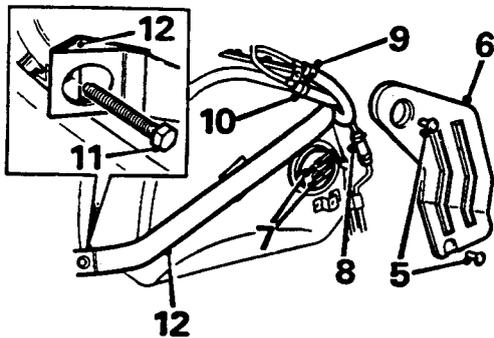

19M0147

5. Remove 2 studs securing fuel tank side cover.
6. Remove protection cover.
7. Disconnect 2 Lucars from fuel tank sender unit.
8. Release clip, disconnect tank vent hose, plug hose.
9. Release clip, disconnect fuel feed hose, plug hose.
10. Release clip, disconnect fuel return hose, plug hose.
11. Remove bolt securing fuel tank retaining strap to body.
12. Remove reinforcing plate, move strap aside.

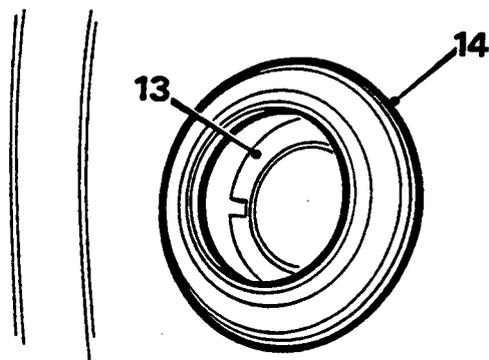

19M0148

13. Release tank from filler neck grommet.
14. Remove grommet.

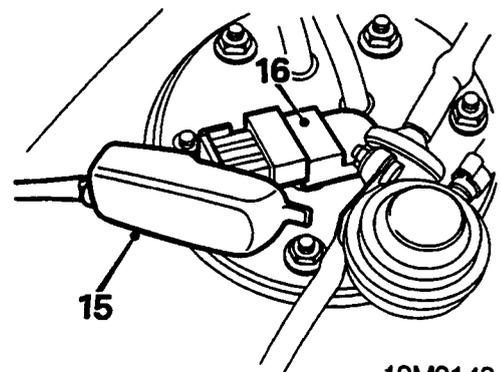

19M0149

15. Release cover from multiplug.
16. Disconnect multiplug from fuel pump.
17. Remove fuel tank.

Do not carry out further dismantling if component is removed for access only

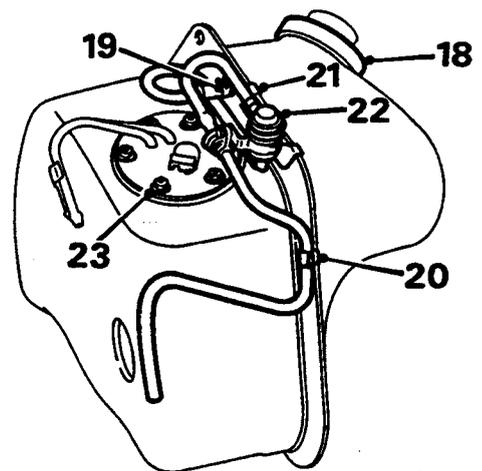

19M0150

18. Remove filler neck seal.
19. Release clip and disconnect vent hose from tank.
20. Release vent pipe from clip on side of tank, remove clip.
21. Remove edge clip securing valve bracket.
22. Remove valve and bracket assembly.
23. Remove fuel pump.

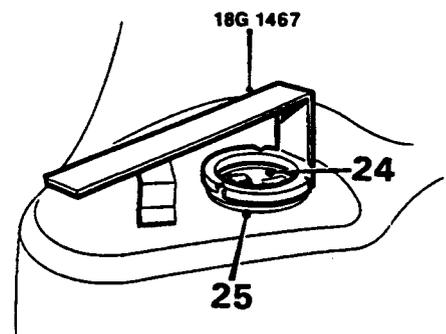

19M0151

24. Remove fuel gauge sender unit, using tool **18G 1467.**
25. Remove seal.

FUEL DELIVERY SYSTEM

Refit

1. Clean tank and sender unit mating faces.
2. Fit seal and sender unit.
3. Clean tank and pump mating faces.
4. Fit seal and pump.
5. Fit valve and bracket assembly and secure with edge clip.
6. Secure vent pipe with clip.
7. Connect vent hose and secure clip.
8. Fit seal to filler neck.
9. Position tank and connect multiplug to fuel pump.
10. Secure cover to multiplug.
11. Fit grommet to filler neck.
12. Manoeuvre tank into position and position tank strap.
13. Fit reinforcing plate, fit and tighten strap bolt.
14. Remove plugs, connect return, feed and vent hoses, secure clips.
15. Connect Lucars to fuel gauge sender unit.
16. Fit protection cover and secure with studs.
17. Fit spare wheel and cover.
18. Connect battery earth lead.

INERTIA SWITCH - SPI MODELS

Service Repair No. 19.22.09

Remove

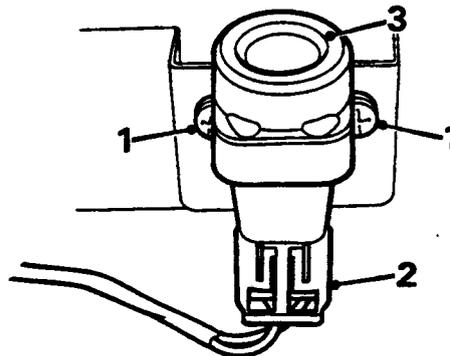

19M0152

1. Remove 2 screws securing inertia switch to bulkhead.
2. Disconnect switch multiplug.
3. Remove switch.

Refit

1. Connect multiplug to switch.
2. Fit switch to bulkhead, fit and tighten screws.
3. Set switch.



FUEL PUMP - SPi MODELS

Service Repair No. 19.45.08

Remove

1. Disconnect battery earth lead.
2. Remove fuel tank, see Fuel tank - SPi models.

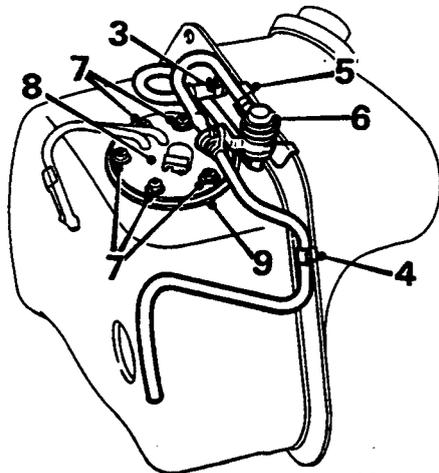

19M0153

3. Release clip and disconnect vent hose from tank.
4. Release vent pipe from clip on tank.
5. Remove edge clip securing valve bracket.
6. Remove valve and bracket assembly.
7. Remove 6 nuts securing fuel pump.
8. Remove fuel pump.
9. Remove seal.

Refit

1. Clean fuel pump and tank mating faces.
2. Fit seal and pump to tank.
3. Fit nuts and tighten to 9 Nm.
4. Fit valve and bracket assembly.
5. Secure bracket with edge clip.
6. Fit vent pipe to clip.
7. Connect vent hose and secure clip.
8. Fit fuel tank, see Fuel tank - SPi models.
9. Connect battery earth lead.

FUEL TANK BREATHER TWO-WAY VALVE

Service Repair No. 19.55.25

Remove

1. Disconnect battery earth lead.
2. Remove fuel tank
Carburettor models: see Fuel tank - Carburettor models.
SPi models: see Fuel tank - SPi models.

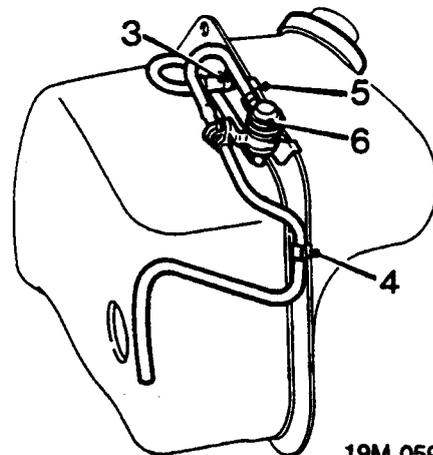

19M 0592

3. Release clip and disconnect vent hose from tank.
4. Release vent pipe from clip on side of tank.
5. Remove edge clip securing valve bracket.
6. Remove valve and bracket assembly.

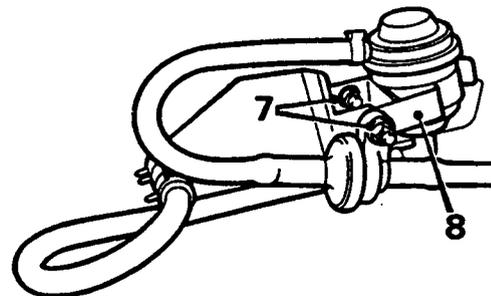

19M0155

7. Remove nuts securing valve to bracket.
8. Remove bracket from valve and pipe assembly.

FUEL DELIVERY SYSTEM

Refit

1. Fit valve and pipe assembly to bracket and tighten nut to 9 Nm.
2. Fit valve and bracket assembly and secure with edge clip.
3. Secure vent pipe with clip.
4. Connect vent hose and secure clip.
5. Fit fuel tank
Carburettor models: see **Fuel tank - Carburettor models.**
SPi models: see **Fuel tank - SPi models.**
6. Connect battery earth lead.

COOLING SYSTEM

CONTENTS

REPAIRS

	Page
Drive belt	1
Cooling fan	1
Auxiliary cooling fan	2
Thermostatic switch	3
Radiator block	3
Thermostat	5
Coolant pump	6





DRIVE BELT

Service Repair No. 26.20.07.

Remove

1. Release fasteners and remove splash shield.

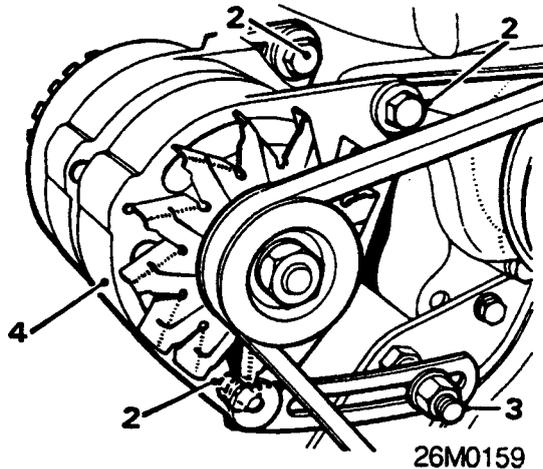

2. Slacken the alternator securing bolts.
3. Slacken the adjusting link nut.
4. Move the alternator towards the engine and remove the belt from the pulleys by passing it over the fan blades.

Refit

1. Position the belt on the pulleys.
2. Adjust the belt, see **MAINTENANCE**.
3. Fit splash shield.

COOLING FAN

Service Repair No. 25.25.06.

Remove

1. Remove radiator, see **Radiator block**.

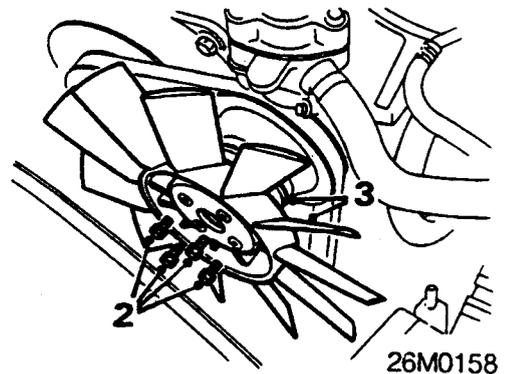

2. Remove 4 bolts from cooling fan.
3. Remove the fan and spacer.

Refit

1. Fit spacer and fan to pulley.
2. Tighten fan bolts to 11 Nm.
3. Fit radiator.

COOLING SYSTEM

AUXILIARY COOLING FAN

Service Repair No. 26.25.23

Remove

1. Disconnect battery earth lead.
2. Remove front grille, see **BODY**

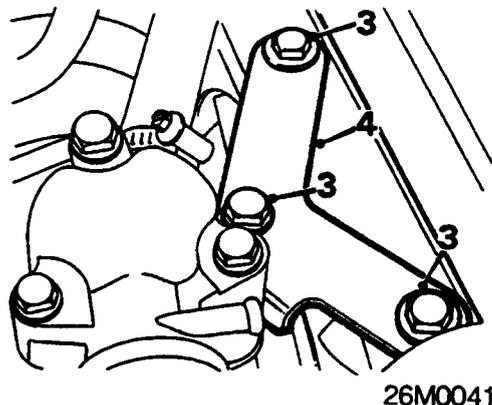

3. Remove 3 bolts securing radiator top bracket.
4. Remove bracket.

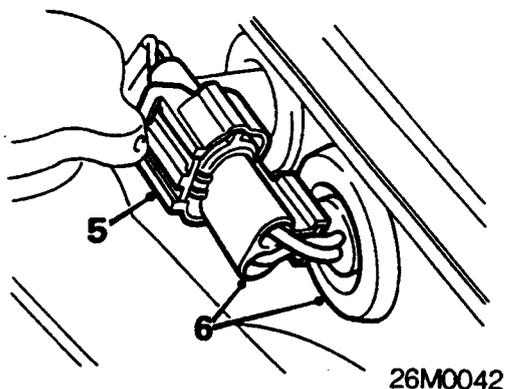

5. Disconnect multiplug from fan motor.
6. Release grommet and multiplug from wing valance.

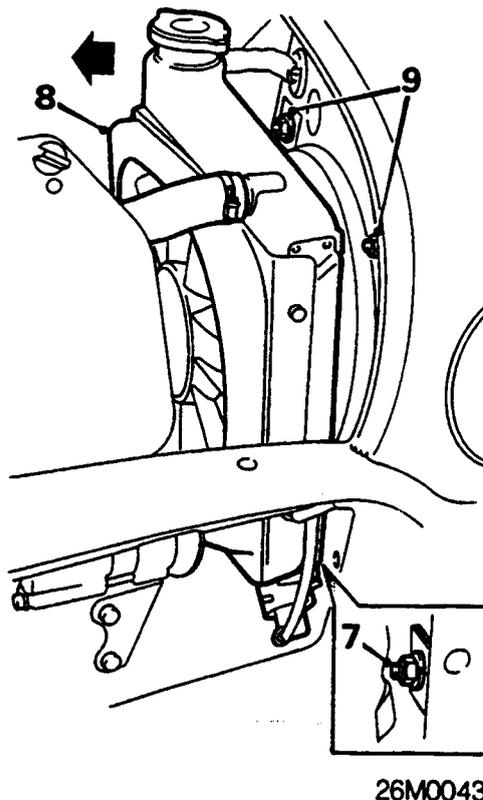

7. Remove lower nut securing fan motor mounting.
8. Move radiator away from wing valance.
9. Remove 2 upper nuts securing fan motor mounting.
10. Remove fan and motor assembly.

Refit

1. Fit fan and motor assembly, passing harness and multiplug through wing valance.
2. Fit and tighten 2 upper nuts securing fan motor mounting.
3. Fit and tighten lower nut securing mounting.
4. Connect multiplug.
5. Secure harness grommet.
6. Fit radiator top mounting bracket, fit and tighten 3 bolts.
7. Fit front grille, see **BODY**
8. Connect battery earth lead.



THERMOSTATIC SWITCH

Service Repair No. 26.25.35

Remove

1. Disconnect battery earth lead.
2. Remove front grille, see **BODY**
3. Drain cooling system, see **MAINTENANCE**.

WARNING: Since injury such as scalding could be caused by escaping steam or coolant, do not remove the pressure relief cap from the radiator while the system is hot. Wait until the system has cooled, use a cloth or glove to protect hands from escaping steam.

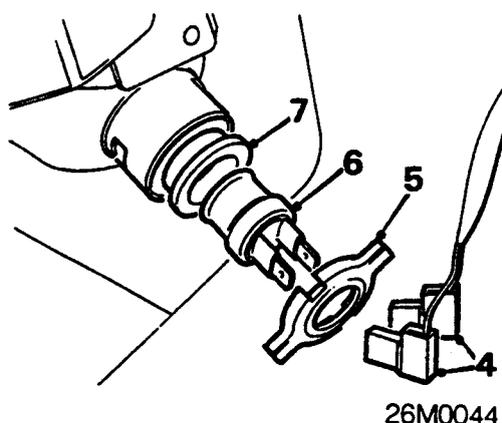

4. Disconnect 2 Lucars from thermostatic switch.
5. Remove switch locking ring.
6. Remove switch from radiator.
7. Remove sealing ring.

Refit

1. Clean switch and radiator mating faces.
2. Fit new sealing ring to switch.
3. Fit switch to radiator.
4. Fit switch locking ring.
5. Connect Lucars to switch
6. Refill cooling system, see **MAINTENANCE**.
7. Fit front grille, see **BODY**
8. Connect battery earth lead.

RADIATOR BLOCK

Service Repair No. 26.40.04

Remove

1. Disconnect battery earth lead.
2. Raise front of vehicle.

WARNING: Support on safety stands.

3. Remove front grille, see **BODY**
4. Drain cooling system, see **MAINTENANCE**.

WARNING: Since injury such as scalding could be caused by escaping steam or coolant, do not remove the pressure relief cap from the radiator while the engine is hot. Wait until the system has cooled, use a cloth or glove to protect hands from escaping steam.

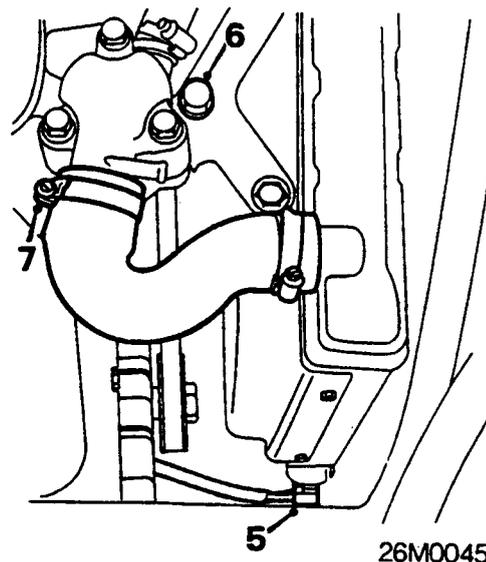

5. Disconnect 2 Lucars from thermostatic switch.
6. Remove bolt securing the radiator top bracket to thermostat housing.
7. Slacken clip and disconnect radiator top hose from thermostat housing.

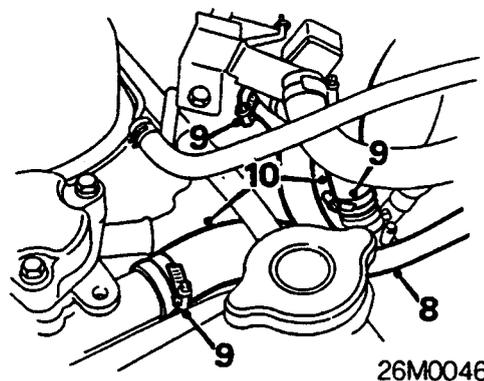

8. Disconnect expansion hose.
9. Slacken 3 clips securing radiator bottom hose to water pump, heater hose connection and coolant pipe.
10. Disconnect hoses.

COOLING SYSTEM

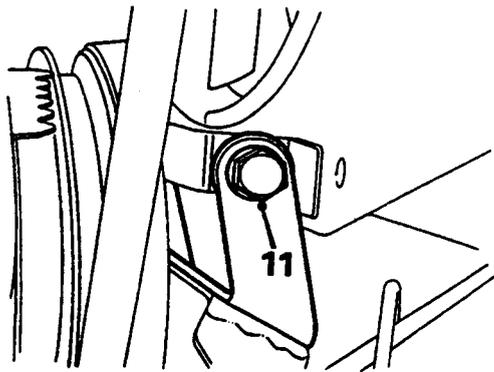

26M0047

11. Remove bolt securing the radiator to bottom bracket.
12. Support power unit on jack.

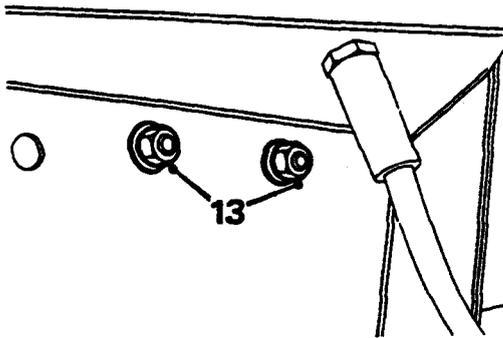

26M0048

13. Remove 2 nuts and bolts securing the engine L.H. mounting to subframe.
14. Raise power unit.
15. Release and remove radiator and cowl assembly.

Do not carry out further dismantling if component is removed for access only

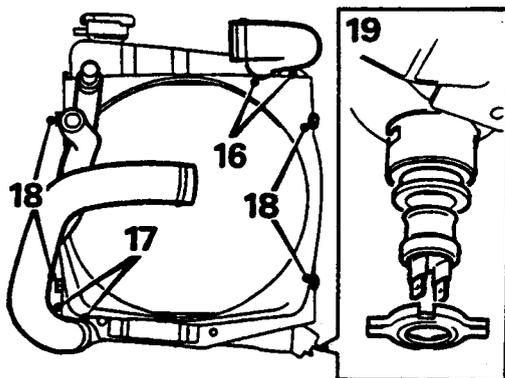

26M0049

16. Slacken clip and disconnect the top hose from radiator.
17. Slacken clip and disconnect bottom hose from radiator.
18. Remove 4 bolts securing cowl assembly.

19. Remove thermostatic switch.

Refit

1. Fit thermostatic switch with new sealing ring.
2. Fit cowl assembly and tighten bolts to 5 Nm.
3. Fit expansion tank.
4. Fit top and bottom hoses to radiator and tighten clips.
5. Fit radiator into position. Fit bottom bolt and tighten to 22 Nm.
6. Lower power unit to align mounting.
7. Fit nuts and bolts securing engine L.H. mounting and tighten to 22 Nm.
8. Remove jack.
9. Connect hoses and tighten clips.
10. Fit radiator top bracket and tighten securing bolt to 22 Nm.
11. Connect Lucars to thermostatic switch.
12. Remove stand(s) and lower vehicle.
13. Fit front grille, see **BODY**
14. Refill cooling system, see **MAINTENANCE**.
15. Connect battery earth lead.



THERMOSTAT

Service Repair No. 26.45.01

Remove

1. Disconnect battery earth lead.
2. Drain cooling system, see **MAINTENANCE**.

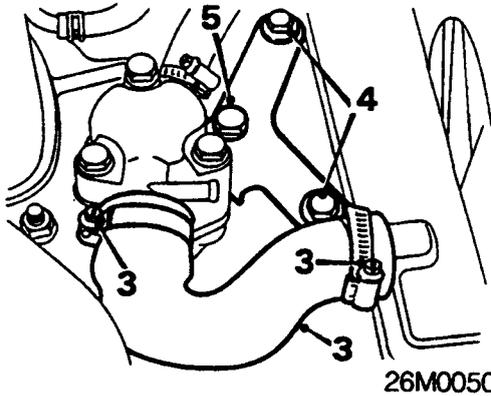

3. Slacken 2 hose clips and remove top hose.
4. Remove 2 bolts securing top mounting bracket to radiator.
5. Remove bolt securing top mounting bracket to thermostat housing.

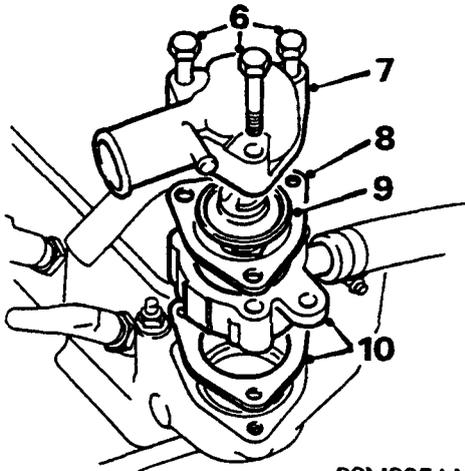

6. Remove 3 bolts securing thermostat housing.
7. Remove thermostat upper housing.
8. Remove gasket.
9. Remove thermostat.
10. Remove thermostat lower housing and gasket.

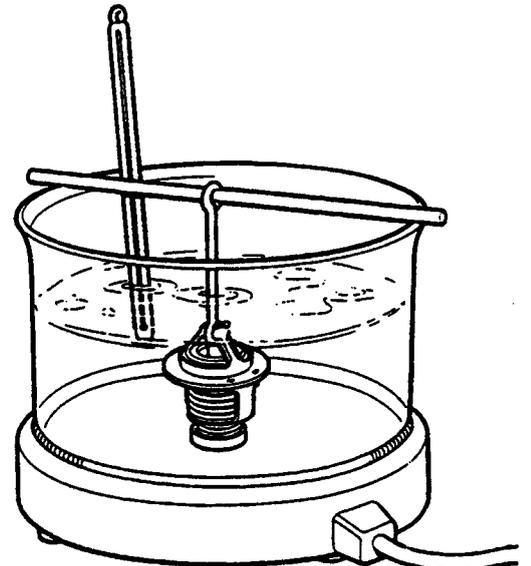

11. Test thermostat using thermostat test equipment, renew thermostat if necessary. Thermostat opening temperature = 88°C.

Refit

1. Clean thermostat housing and mating faces.
2. Fit gasket and thermostat lower housing.
3. Fit thermostat and upper housing gasket.
4. Fit thermostat upper housing and tighten bolts to 11 Nm.
5. Fit radiator top mounting bracket, fit securing bolts and tighten to 22 Nm.
6. Fit radiator top hose and tighten clips.
7. Refill cooling system, see **MAINTENANCE**.
8. Connect battery earth lead.

COOLING SYSTEM

COOLANT PUMP

Service Repair No. 26.50.01

Remove

1. Drain cooling system, see **MAINTENANCE**.
2. Remove radiator, see **Radiator block**.
3. Remove drive belt, see **Drive belt**.
4. Remove cooling fan, see **Cooling fan**.

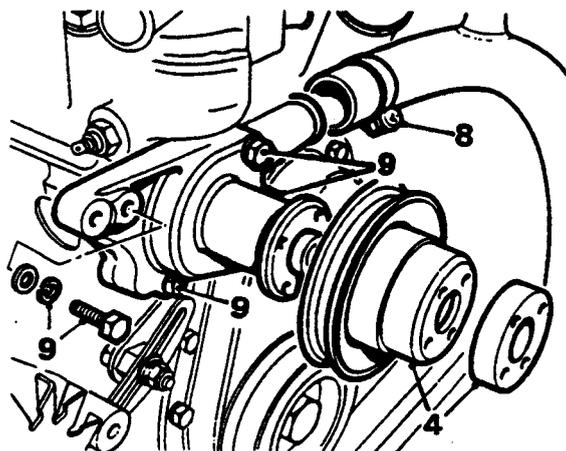
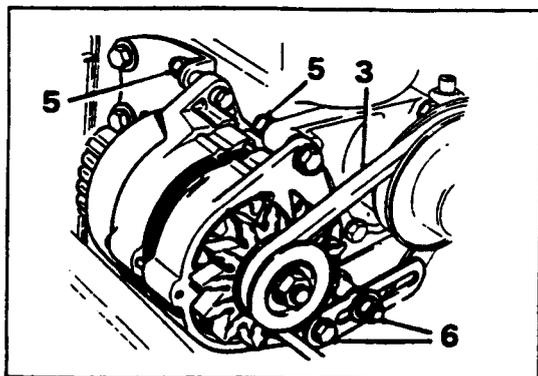

26M0157

5. Remove cooling fan pulley.
6. Remove 2 bolts securing the top of the alternator to the coolant pump and cylinder block.
7. Slacken alternator lower bolts and move alternator aside.
8. Release clip and disconnect radiator bottom hose from coolant pump.
9. Remove 4 bolts securing coolant pump to cylinder block.
10. Remove coolant pump.

Refit

1. Remove all traces of gasket from coolant pump and cylinder block.
2. Fit new gasket to coolant pump.
3. Position pump to cylinder block.
4. Tighten coolant pump bolts to 22 Nm.
5. Fit bottom hose to pump and tighten clip.
6. Re-position alternator and tighten securing bolts to 22 Nm.
7. Refit cooling fan pulley.
8. Refit cooling fan, see **Cooling fan**.
9. Refit drive belt, see **Drive belt**.
10. Adjust belt tension, see **MAINTENANCE**.
11. Refit radiator, see **Radiator block**.
12. Refill cooling system, see **MAINTENANCE**.

MANIFOLD & EXHAUST

CONTENTS

DESCRIPTION AND OPERATION	Page
Exhaust system components	2
Inlet manifold	3
Exhaust manifold	3
Exhaust system	3

REPAIRS	Page
Manifold gasket (SPi models)	1
Manifold gasket (carburettor models)	3
Exhaust front pipe	4
Catalytic converter	5
Tail pipe and silencer	6

MANIFOLD & EXHAUST

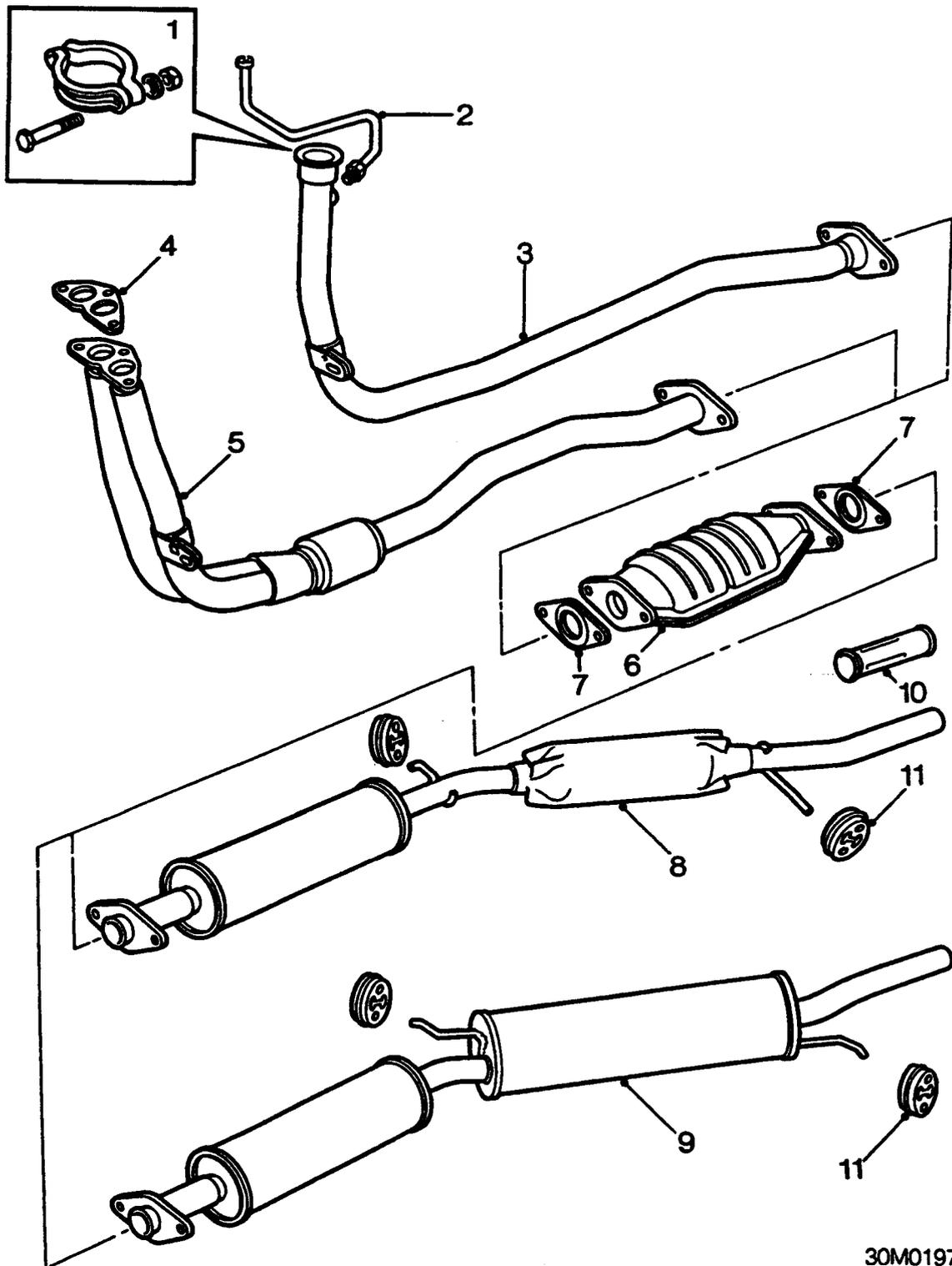

30M0197

EXHAUST SYSTEM COMPONENTS

1. Exhaust front pipe clamp (carburettor models)
2. Exhaust sampler pipe (carburettor models)
3. Exhaust front pipe (carburettor models)
4. Exhaust front pipe gasket (SPi models).

5. Exhaust front pipe (SPi models).
6. Catalytic converter (all models).
7. Gasket.
8. Tail pipe and silencer (carburettor models).
9. Tail pipe and silencer (SPi models).
10. Tail pipe finisher.
11. Exhaust rubber mountings.



INLET MANIFOLD

Carburettor models:

The cast iron inlet manifold is an integral part of the exhaust manifold. This design incorporates a inlet manifold hot – spot situated between the centre exhaust port and the inlet manifold section, which improves engine performance and cold engine driveability.

SPi models:

The inlet manifold is an aluminium casting, which incorporates a manifold heater and manifold heater switch. The switch provides engine temperature input to the Engine Management ECU, which controls the manifold heater circuit via the manifold heater relay. This provides optimum inlet manifold temperature during cold engine/warm up conditions. To supplement this feature the inlet manifold is also heated from the cooling system to improve driveability.

EXHAUST MANIFOLD

Carburettor models:

The exhaust manifold is fitted with a hot air box which is connected to the intake system, this provides warm air to the carburettor during engine warm up.

SPi models:

The cast iron exhaust manifold is fitted with a Heated Oxygen Sensor (HO2S). To assist the extraction of exhaust gases the manifold is divided into two outlets, number 2 and 3 cylinders discharge into one half of the manifold and 1 and 4 cylinders into the other half.

EXHAUST SYSTEM

The exhaust system consists of a front pipe, catalytic converter and a silencer/ tail pipe assembly, which incorporates two silencers. Both silencers contain a series of expansion chambers, resonators and baffles designed to give an improved exhaust system, eliminate condensation and give longer life to the system.

Catalytic converter

A catalytic converter can be operated in either an "open – loop" or "closed – loop" system.

Open – loop :

The system operates without exhaust gas monitoring. An exhaust gas sampling pipe is located in the front pipe ahead of the catalytic converter to allow exhaust emissions to be checked.

Closed – loop :

A Heated Oxygen Sensor (HO2S), located in the exhaust manifold is used to monitor the exhaust gases. This sensor sends a signal to the Engine Management ECU which modifies the engine fuelling to maintain exhaust emissions and optimum catalytic converter performance.

MANIFOLD GASKET - SPI MODELS

Service Repair No. 30.15.15

Remove

1. Disconnect battery earth lead.
2. Raise front of vehicle.

WARNING: Support on safety stands.

3. Remove bonnet, see **BODY**
4. Remove air cleaner, see **MODULAR ENGINE MANAGEMENT SYSTEM**.

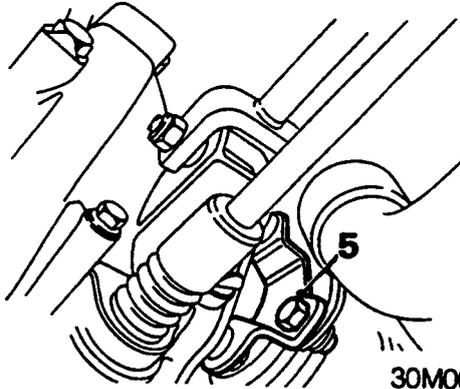

30M0056

5. Slacken bolt securing exhaust front pipe clip to transmission bracket.

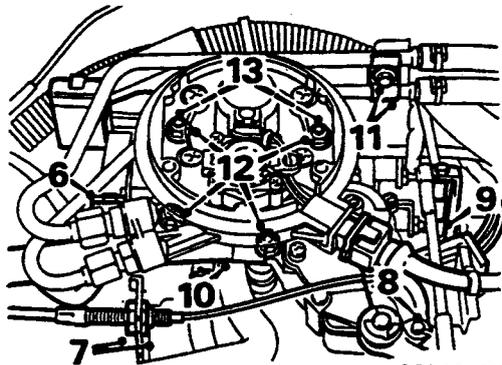

30M0057

6. Disconnect multiplug from throttle potentiometer
7. Release throttle cable from abutment bracket.
8. Disconnect throttle inner cable from cam.
9. *Automatic gearbox models:* Disconnect down shift rod from throttle lever.
10. Disconnect breather hose from throttle body.
11. Remove screw from fuel pipe clip and remove clip.
12. Remove 4 nuts securing throttle body.
13. Lift throttle body and fuel pipe bracket from manifold studs.

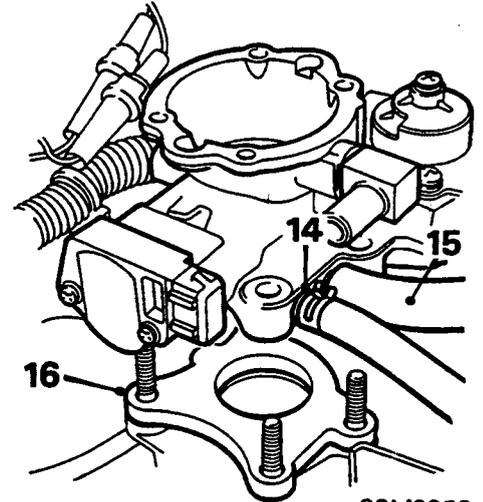

30M0058

14. Release clip and disconnect purge hose from pipe.
15. Disconnect breather hose from pipe.
16. Remove throttle body spacer from studs.
17. Drain cooling system, see **MAINTENANCE**.

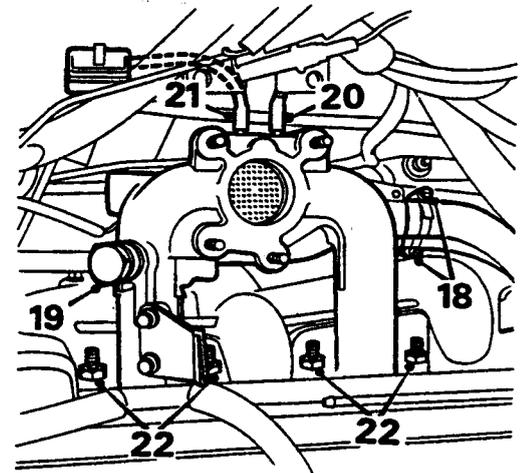

30M0059

18. Slacken 2 hose clips and disconnect coolant hoses from manifold and manifold pipe.
19. Remove servo banjo bolt and washers.
20. Disconnect red vacuum pipe from manifold.
21. Disconnect black vacuum pipe from manifold.
22. Remove 4 nuts securing inlet manifold, withdraw manifold.

MANIFOLD & EXHAUST

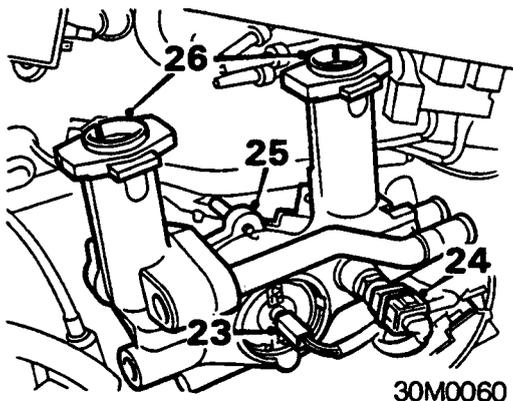

30M0060

23. Disconnect Lucar from manifold heater.
24. Disconnect multiplug from manifold heater switch.
25. Remove inlet manifold.
26. Remove 2 ring dowels.

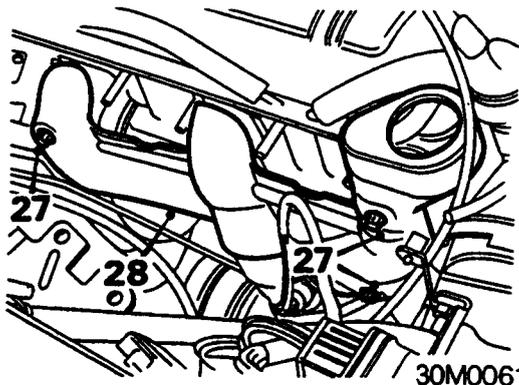

30M0061

27. Remove 3 bolts securing heat shield to exhaust manifold.
28. Remove heat shield.

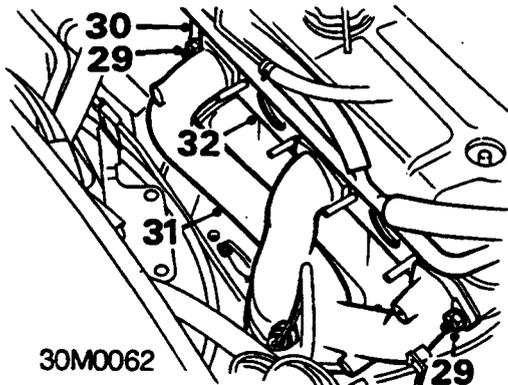

30M0062

29. Remove 2 nuts securing exhaust manifold.
30. Release breather pipe from manifold stud.
31. Release exhaust manifold from studs.
32. Remove manifold gasket.

Refit

1. Clean mating faces of both manifolds and cylinder head.
2. Fit manifold gasket and exhaust manifold to studs.
3. Fit breather pipe to manifold stud.
4. Fit 2 exhaust manifold nuts and tighten to 22 Nm.
5. Tighten bolt securing exhaust front pipe clip to transmission bracket.

6. Fit heat shield, fit and tighten bolts.
7. Clean and fit ring dowels.
8. Position inlet manifold and connect multiplug to manifold heater switch and Lucar to manifold heater.
9. Fit inlet manifold, fit 4 nuts and tighten to 22 Nm.
10. Connect black vacuum pipe to manifold.
11. Connect red vacuum pipe to manifold.
12. Position washers on each side of servo banjo union, fit banjo bolt and tighten to 50 Nm.
13. Connect coolant hoses to manifold and manifold pipe, tighten hose clips.
14. Clean mating faces and fit throttle body spacer.
15. Position throttle body and connect breather hose.
16. Connect purge hose and secure clip.
17. Fit throttle body and fuel pipe bracket to manifold studs.
18. Fit throttle body nuts and tighten to 10 Nm.
19. Fit fuel pipe clip and tighten screw.
20. Connect breather hose to throttle body.
21. Connect multiplug to throttle potentiometer.
22. *Automatic gearbox models:* Connect down shift rod to throttle lever.
23. Connect throttle inner cable to cam.
24. Secure throttle cable in abutment bracket.
25. Check/adjust throttle cable, see **MODULAR ENGINE MANAGEMENT SYSTEM**.
26. Fit air cleaner, see **MODULAR ENGINE MANAGEMENT SYSTEM**.
27. Fit bonnet, see **BODY**
28. Remove stand(s) and lower vehicle.
29. Refill cooling system, see **MAINTENANCE**.
30. Connect battery earth lead.



MANIFOLD GASKET - CARBURETTER MODELS

Service Repair No. 30.15.15.

Remove

1. Disconnect battery earth lead.
2. Raise front of vehicle.

WARNING: Support on safety stands.

3. Remove bonnet, see **BODY**.
4. Remove air cleaner, see **CARBURETTER & IGNITION**.

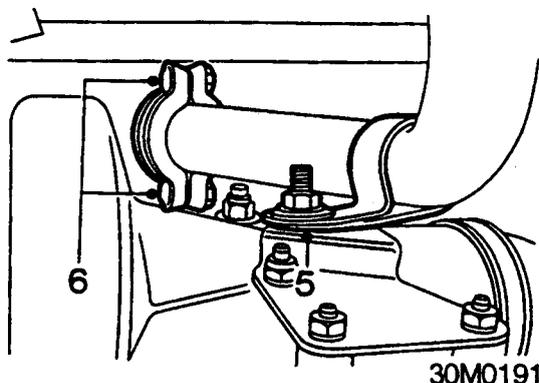

5. Remove bolt securing exhaust front pipe to gearbox bracket.
6. Slacken 2 bolts securing exhaust front pipe clamp to manifold.
7. Release exhaust front pipe from manifold.
8. Remove carburetter, see **CARBURETTER & IGNITION**.

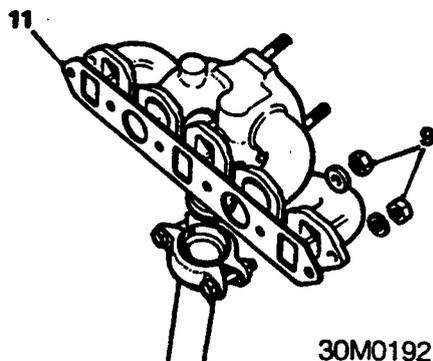

9. Remove 6 nuts and washers securing manifold, withdraw manifold.
10. Remove the hot air shroud.
11. Remove manifold gasket.

Refit

1. Clean mating faces of manifold and cylinder head.
2. Fit manifold gasket and manifold to studs.
3. Fit manifold nuts and tighten to 19 Nm.
4. Fit the insulation block and abutment bracket to manifold.
5. Position carburetter assembly to manifold and tighten nuts, see **CARBURETTER & IGNITION**.

6. *Automatic gearbox models:* Connect down shift rod to throttle lever.
7. Secure throttle cable in abutment bracket.
8. Check/adjust throttle cable, see **CARBURETTER & IGNITION**.
9. Secure choke outer cable to abutment bracket.
10. Connect the fuel hose to the carburetter assembly, tighten clip.
11. Connect the engine breather hose.
12. Connect the fuel return hose to the carburetter assembly, tighten clip.
13. Connect the vacuum advance pipe.
14. Position washers on each side of servo banjo union, fit and tighten banjo bolt to 50 Nm.
15. Fit gasket to exhaust front pipe.
16. Fit exhaust front pipe to manifold and tighten nuts to 22 Nm.
17. Refit bolt exhaust front pipe to gearbox bracket to 22 Nm.
18. Refit air cleaner, see **CARBURETTER & IGNITION**.
19. Remove stand(s) and lower vehicle.
20. Refit bonnet, see **BODY**.
21. Connect battery earth lead.

MANIFOLD & EXHAUST

FRONT PIPE

Service Repair No. 30.10.05.

Remove

1. Raise vehicle on a ramp.
2. Remove tail pipe and silencer, see **Tail pipe and silencer**.
3. Remove catalytic converter, see **Catalytic converter**.

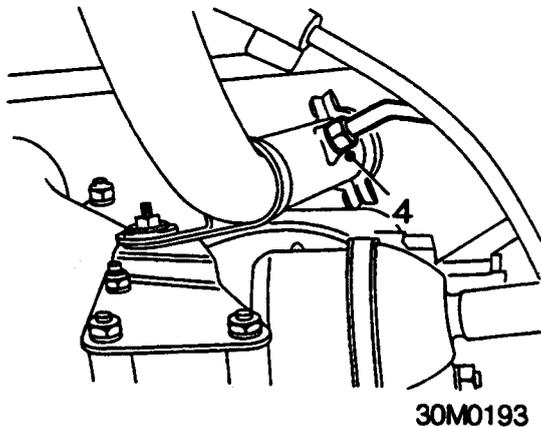

Carburettor models

4. Unscrew union securing sample pipe to exhaust front pipe, release sample pipe.

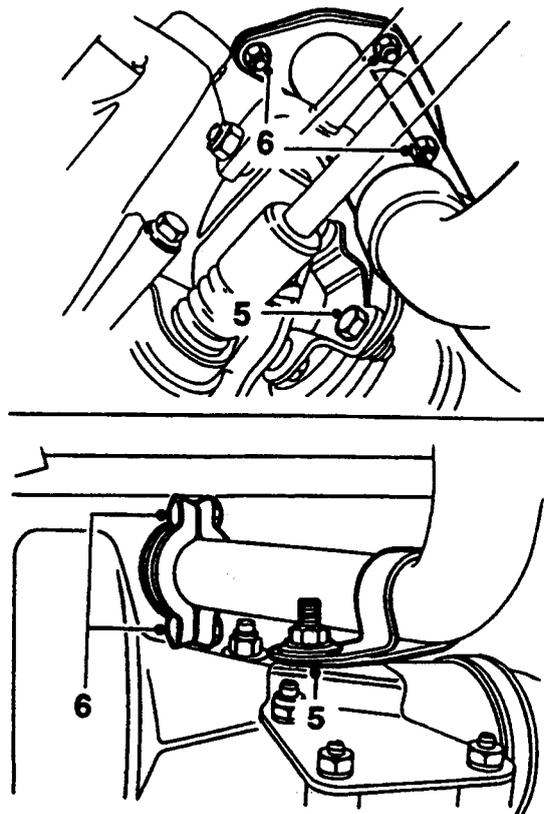

All models

5. Remove nut and bolt securing front pipe to gearbox housing bracket.
6. *SPi models*: Release 3 nuts securing front pipe to exhaust manifold.
Carburettor models: Release 2 bolts securing front pipe clamp to exhaust manifold.
7. Collect gasket (if fitted).

Refit

1. Fit front pipe to exhaust manifold and tighten nuts to 22 Nm.
2. Fit bolt securing front pipe to gearbox housing bracket and tighten nut to 22 Nm.

Carburettor models

3. Tighten union securing sample pipe to exhaust front pipe to 22 Nm.
4. Fit bolt securing sample pipe bracket to exhaust front pipe and tighten to 22 Nm.

All models

5. Refit catalytic converter, see **Catalytic converter**.
6. Refit tail pipe and silencer, see **Tail pipe and silencer**.
7. Lower ramp.



CATALYTIC CONVERTER

Service Repair No. 17.50.01.

Remove

1. Raise vehicle on a ramp.
2. Remove tail pipe and silencer, see **Tail pipe and silencer**.

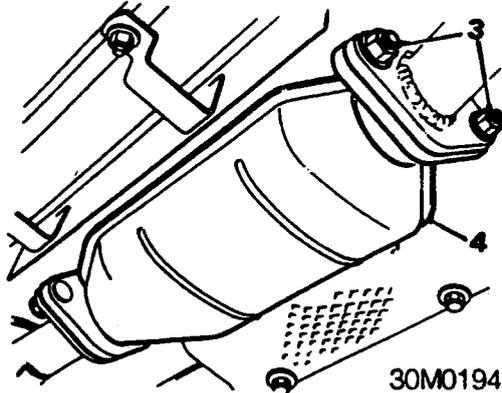

3. Remove two nuts securing front pipe to catalytic converter.
4. Remove catalytic converter and flange gasket.

Refit

1. Ensure flanges are clean and fit new gaskets.
2. Fit catalytic converter to front pipe and tighten nuts to 45 Nm.
3. Refit tail pipe and silencer, see **Tail pipe and silencer**.
4. Lower ramp.

MANIFOLD & EXHAUST

TAIL PIPE AND SILENCER

Service Repair No. 30.10.22.

Remove

1. Raise vehicle on a ramp.

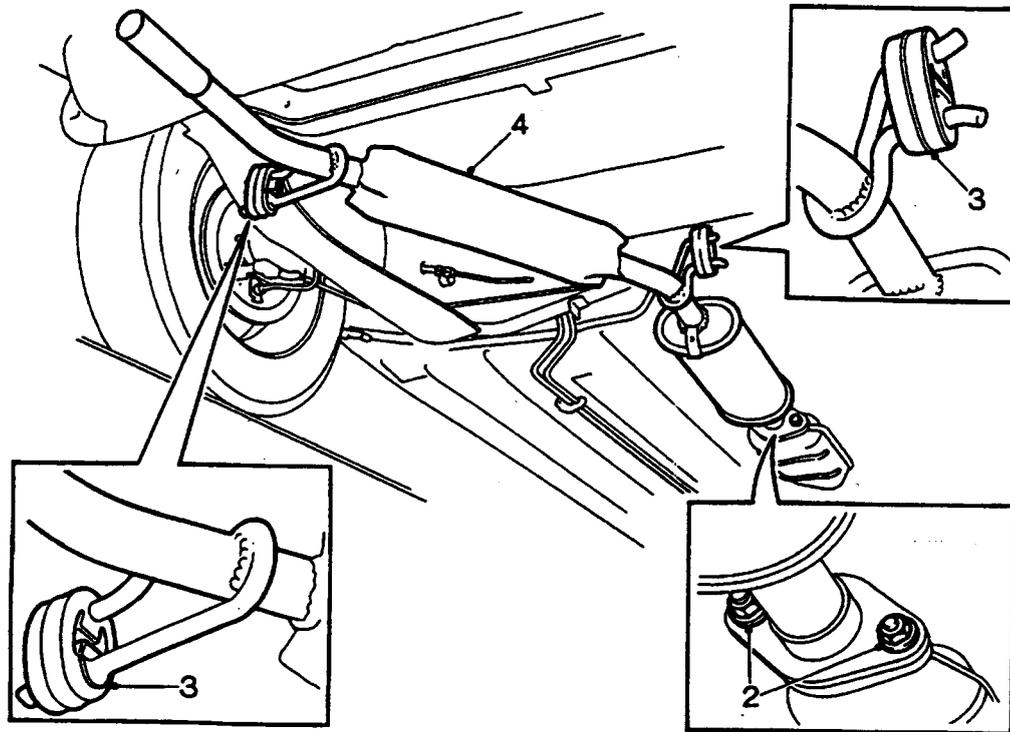

30M0195

2. Remove 2 nuts securing tail pipe to catalytic converter.
3. Release tailpipe and silencer from mounting rubbers.
4. Remove tail pipe assembly, collect flange gasket.

Refit

1. Ensure flanges are clean and new gaskets are used.
2. Position tail pipe and fit into mounting rubbers.
3. Fit nuts securing tail pipe to catalytic converter and tighten to 9 Nm.
4. Lower ramp.

CLUTCH

CONTENTS

Description and Operation	Page
Clutch components	2

Adjustments	Page
Bleed hydraulic system	1
Throw - out stop - adjust	1

Repairs	Page
Master cylinder	1
Master cylinder - overhaul	2
Slave cylinder	3
Slave cylinder - overhaul	3
Clutch pedal	4
Release bearing	4
Clutch plate - Carburetter models	4
Clutch plate - SPi models	7



CLUTCH

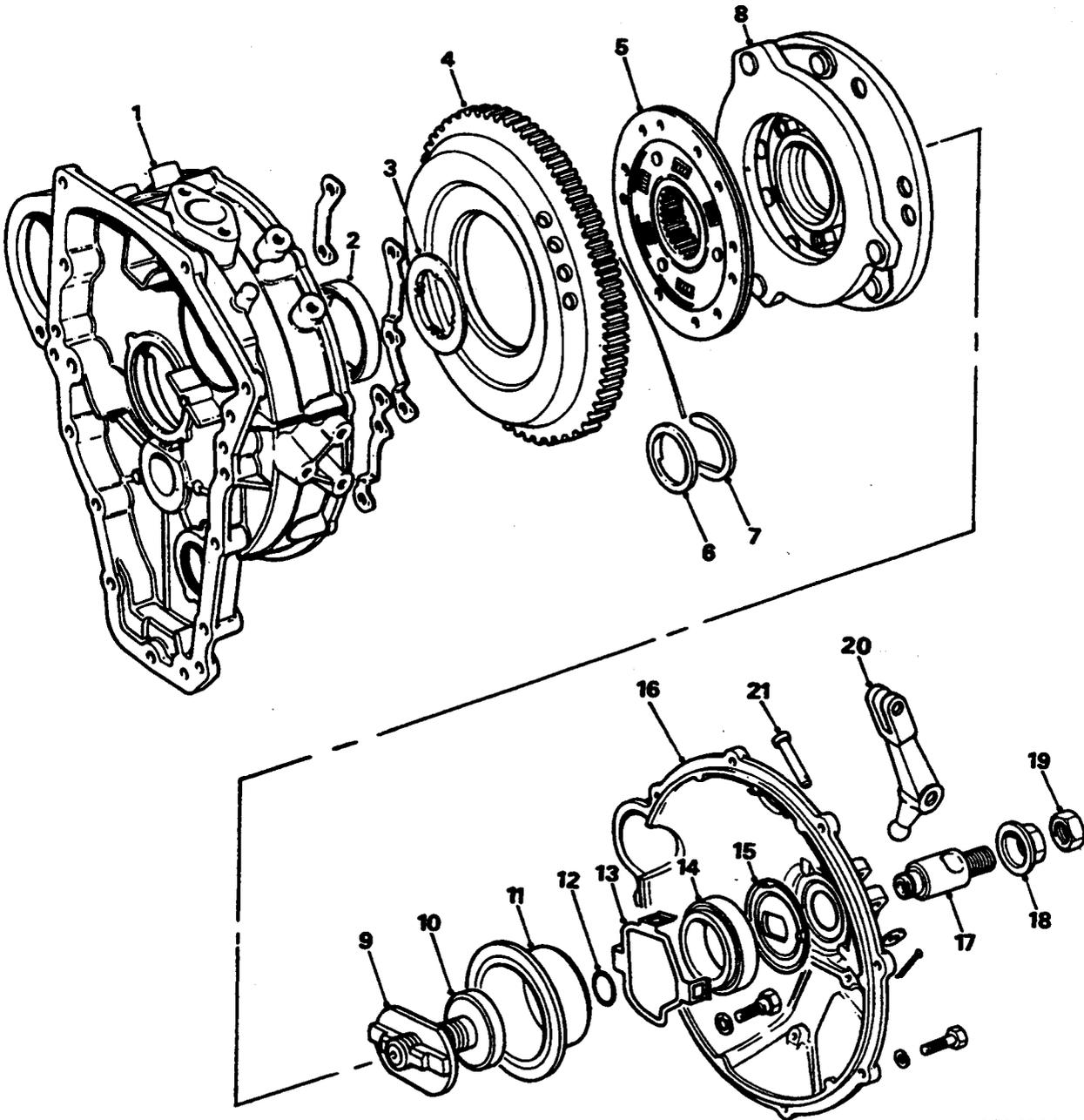

33M0084

CLUTCH COMPONENTS

- | | |
|---|-----------------------------|
| 1. Flywheel housing | 12. 'O' ring |
| 2. Primary gear oil seal | 13. Spring clip |
| 3. Dust shield | 14. Release bearing |
| 4. Flywheel | 15. Bearing retainer plate |
| 5. Clutch plate | 16. Clutch cover |
| 6. Crankshaft primary gear backing ring | 17. Plunger |
| 7. 'C' shaped thrust washer | 18. Plunger stop |
| 8. Pressure plate | 19. Locknut |
| 9. Key plate | 20. Release lever |
| 10. Flywheel retaining bolt | 21. Release lever pivot pin |
| 11. Thrust sleeve | |

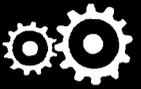

BLEED HYDRAULIC SYSTEM

Service Repair No. 33.15.01

Bleeding

CAUTION: Never re-use fluid which has been bled from system.

Brake fluid has a detrimental effect on paintwork; ensure that fluid is not allowed to contact painted surfaces.

1. Top-up master cylinder with recommended fluid, see **INFORMATION - CAPACITIES, FLUIDS AND LUBRICANTS**.

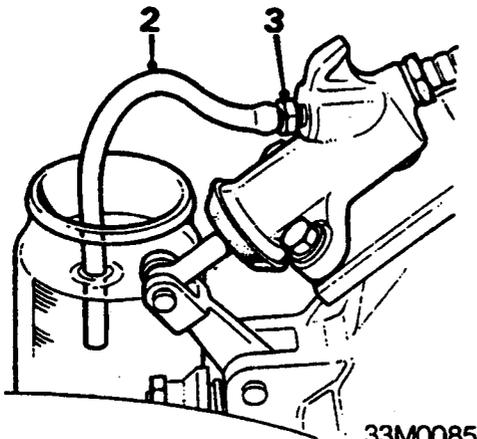

2. Attach a bleed tube to bleed screw on slave cylinder. Immerse other end of tube in a clean jar containing a quantity of fresh brake fluid.
3. Open bleed screw three quarters of a turn, depress pedal and allow it to return unassisted.
4. Continue pumping pedal until fluid is free of air bubbles. Tighten bleed screw.

CAUTION: During bleeding operation, check level of fluid in master cylinder at frequent intervals. Do not allow to fall too far or air will be drawn into system.

5. Remove bleed tube.
6. Top-up master cylinder to correct level and fit cap.

THROW - OUT STOP - ADJUST

Service Repair No. 33.25.01

Adjust

1. *SPi models:* Release 2 screws securing ECU bracket to valance and place ECU aside, see **MODULAR ENGINE MANAGEMENT SYSTEM. - Spi.**

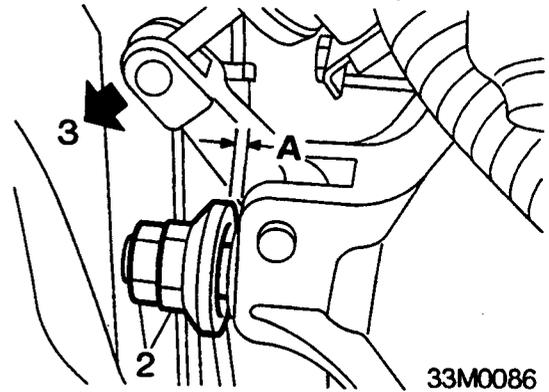

2. Screw plunger stop and locknut away from clutch cover to limit of plunger thread.
3. Take up release bearing free play by pulling release lever from clutch cover until release bearing makes light contact with thrust sleeve.
4. Screw plunger stop in until a gap 'A' of 6.5 mm exists between plunger stop and face of cover and tighten locknut.
5. *SPi models:* Position ECU bracket to valance and secure with the screws, see **MODULAR ENGINE MANAGEMENT SYSTEM. - Spi.**

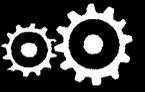

MASTER CYLINDER

Service Repair No. 33.20.01

Remove

SPi models

1. Disconnect battery earth lead.
2. Remove air cleaner, see **MODULAR ENGINE MANAGEMENT SYSTEM - SPi**.

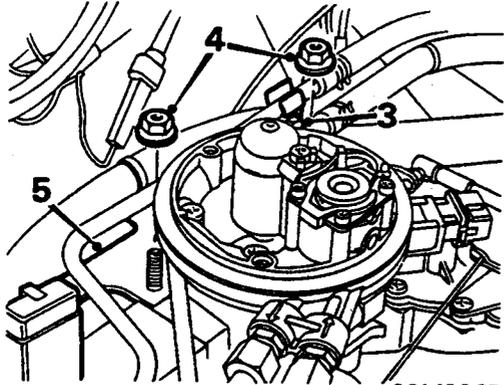

33M0027

3. Remove screw from fuel pipe clip, remove clip.
4. Remove 2 nuts securing bracket to throttle body studs.
5. Remove bracket from studs, move bracket aside.

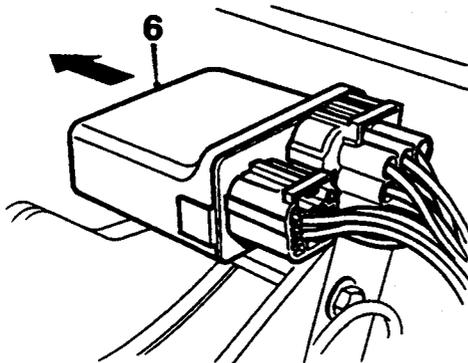

33M0028

6. Release relay module from bracket, move module aside.

All models

7. Fit bleed tube and open bleed screw on clutch slave cylinder. Remove filler cap and pump clutch pedal to drain master cylinder. Tighten bleed screw.

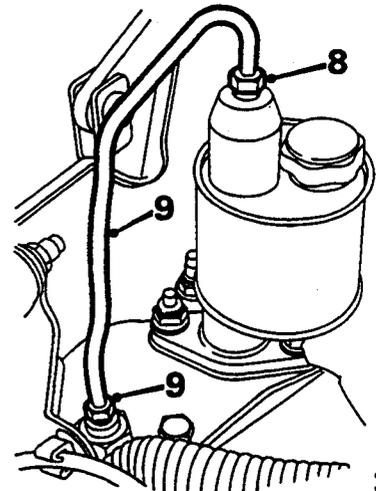

33M0029

8. Disconnect clutch pipe from master cylinder.
9. Disconnect clutch pipe from slave cylinder hose and remove clutch pipe.
10. Plug slave cylinder hose.
11. Disconnect heater fresh air intake duct inside vehicle, remove duct.

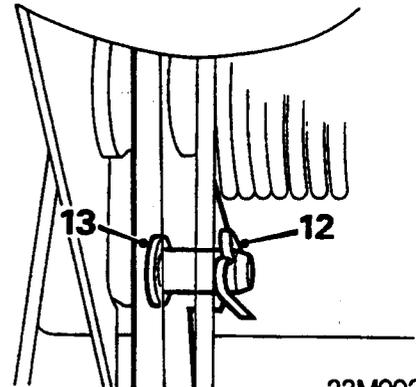

33M0030

12. Remove split pin from clutch pedal clevis pin.
13. Remove clevis pin from clutch pedal.

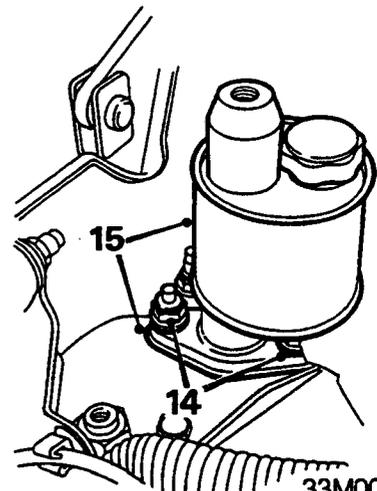

33M0031

14. Remove 2 nuts securing clutch master cylinder.
15. Remove clutch master cylinder and gasket.

CLUTCH

Refit

16. Clean master cylinder mating faces.
17. Fit master cylinder and gasket, ensuring master cylinder push rod is correctly positioned to pedal.
18. Fit and tighten master cylinder nuts.
19. Fit clevis pin and secure with new split – pin.
20. Fit and secure heater fresh air duct.
21. Remove plug from slave cylinder hose.
22. Fit clutch pipe, tighten connections.
23. Fill and bleed clutch hydraulic system, see **Adjustments**.

SPi models

24. Fit relay module to bracket.
25. Fit fuel pipe bracket to throttle body studs, fit and tighten nuts to 10 Nm.
26. Fit fuel pipe clip, tighten screw.
27. Fit air cleaner, see **MODULAR ENGINE MANAGEMENT SYSTEM. – SPi**.
28. Connect battery earth lead.

MASTER CYLINDER – OVERHAUL

Service Repair No. 33.20.07

Dismantling

1. Remove master cylinder, see **Master cylinder**.

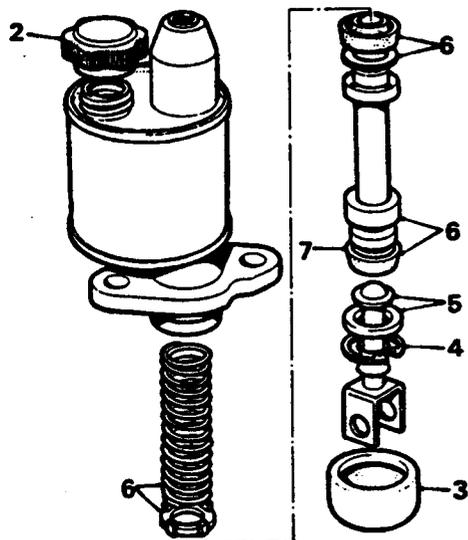

33M0087

2. Thoroughly clean outside of unit. Remove filler cap and drain fluid from reservoir.
3. Detach boot from body and slide it off push – rod.
4. Extract circlip
5. Remove push – rod complete with dished washer.
6. Withdraw piston complete with secondary cup, washer, main cup, spring retainer and spring from body.
7. Remove secondary cup from piston by carefully stretching it over end of piston.

CAUTION: Care must be taken to avoid damaging piston when removing secondary cup.

Inspection

8. Clean cylinder body in industrial methylated spirit. Wash all internal parts in clean brake fluid.
9. Examine master cylinder piston bore; if bore is not scored or ridged, new seals can be fitted. Renew unit if bores are ridged or scored.
10. Check that inlet and outlet ports are free of obstructions.

Reassemble

11. Immerse all components in a recommended brake fluid and assemble when wet.
12. Stretch secondary cup over piston with lip facing head (drilled end) of piston.
13. Fit spring retainer into small diameter end of piston, and insert spring into body, large diameter first.
14. Fit main cup and washer over spring retainer.

CAUTION: When fitting cups, carefully enter lip edge first.

15. Insert piston assembly fully into cylinder bore.
16. Refit push – rod assembly and secure it with circlip.
17. Refit boot to push – rod and attach it to cylinder body.
18. Refit clutch master cylinder, see **Master cylinder**.

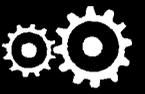

SLAVE CYLINDER

Service Repair No. 33.35.01

Remove

1. Fit bleed tube and open bleed screw on slave cylinder. Remove filler cap and pump clutch pedal to drain system. Tighten bleed screw.

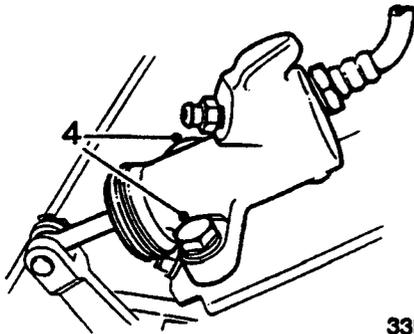
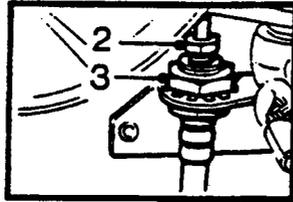

33M0088

2. Disconnect master cylinder pipe from hose at body bracket. Plug end of hose to prevent ingress of dirt.
3. Remove locknut and washer and release hose from bracket. Plug end of hose.
4. Remove 2 bolts and washers securing slave cylinder mounting bracket.
5. Slide slave cylinder off push rod.

Do not carry out further dismantling if component is removed for access only

6. With slave cylinder flange held in a soft jawed vice, remove hose and sealing washer.
7. Use new sealing washer and fit hose to new slave cylinder.

Refit

8. Lubricate push rod with clean brake fluid and insert it into slave cylinder.
9. Locate slave cylinder on mounting bracket; fit and tighten securing bolts.
10. Connect hose to body bracket ensuring that it is not kinked or twisted and that it is still aligned with cylinder.
11. Connect master cylinder pipe to hose.
12. Bleed clutch hydraulic system, see **Adjustments**.

SLAVE CYLINDER - OVERHAUL

Service Repair No. 33.35.07

Dismantle

1. Remove slave cylinder, see **Slave cylinder**.

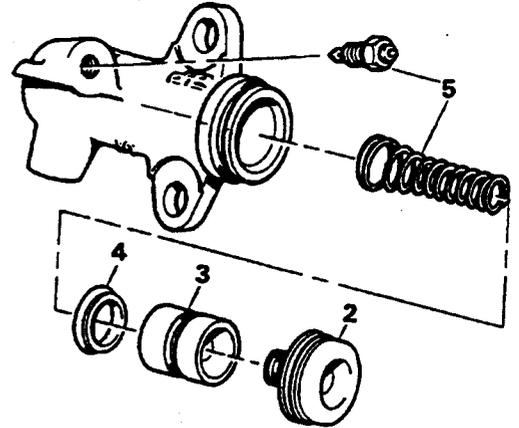

33M0089

2. Remove dust cover from body.
3. Extract piston using an air pressure line.
4. Remove seal from piston.
5. Remove spring and bleed screw.

Inspection

6. Wash slave cylinder body in brake cleaning fluid or industrial alcohol. Clean internal parts in brake fluid.
7. Check cylinder bore; if not scored or ridged, a new seal can be fitted. Renew unit if bore is scored or ridged.

Assemble

8. Immerse all internal parts in brake fluid and assemble when wet.
9. Fit return spring, small end to piston.
10. Fit a new seal onto piston, lip towards spring end. Press piston into bore.
11. Smear sealing areas of dust cover with rubber lubricant before fitting.
12. Fit slave cylinder, see **Slave cylinder**.

CLUTCH

CLUTCH PEDAL

Service Repair No. 33.30.02 - Remove and refit

Service Repair No. 33.30.06 - Overhaul

Remove

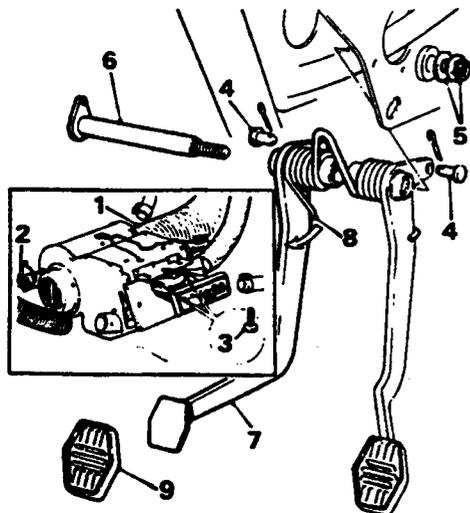

33M0090

1. Disconnect and remove heater air intake flexible tube from heater and wheel arch.
2. Slacken heater securing nut.
3. Remove two screws retaining heater unit to parcel rail and lower heater unit.
4. Remove clevis pins from clutch and brake push - rods.
5. Remove pedal shaft retaining nut and washer.
6. Withdraw pedal shaft.
7. Remove clutch pedal from pedal bracket.

Do not carry out further dismantling if component is removed for access only

8. Detach return spring from clutch pedal.
9. Remove pedal rubber.

Refit

10. Fit new pedal bearings if necessary:
 - a Press worn bearings from tube.
 - b Press a new bearing into each end of tube and slightly below face.
 - c Check shaft rotates freely in tube.
11. Lightly lubricate pedal shaft.
12. Reverse procedure in 1 to 9.

RELEASE BEARING

Service Repair No. 33.25.12

Remove

1. Remove clutch cover assembly, see Clutch Plate.
2. Pull release bearing assembly from plunger and collect 'O' ring.
3. Prise legs of spring clip from bearing retainer plate and remove bearing.

Refit

4. Position bearing on its retainer plate with seal facing away from plate.
5. Fit spring clip, then locate bearing assembly on plunger and fit 'O' ring.
6. Fit clutch cover assembly, see Clutch Plate.
7. Adjust throw - out stop, see Adjustments

CLUTCH PLATE - CARBURETTER MODELS

Service Repair No. 33.10.01

Remove

1. Disconnect battery earth lead.
2. Raise front of vehicle.

WARNING: Support on safety stands.

3. Remove bonnet, see BODY
4. Remove front grille.
5. Release 3 turnbuckles and remove splash shield.
6. Remove bolt and washer securing coil bracket, move coil and bracket aside.
7. Disconnect Lucars from coil.
8. Remove distributor cap together with spark plug leads.
9. Remove starter motor cable retaining strap.
10. Disconnect Lucars from horn.
11. Remove horn.

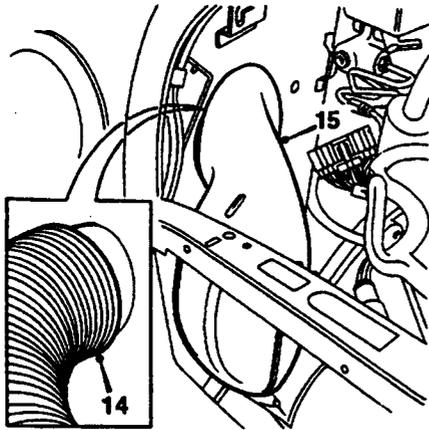
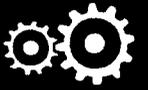

33M0091

12. Disconnect fresh air intake hose from duct under RH front wing.
13. Release and remove fresh air duct from valance.
14. Remove starter motor, see **ELECTRICAL**.

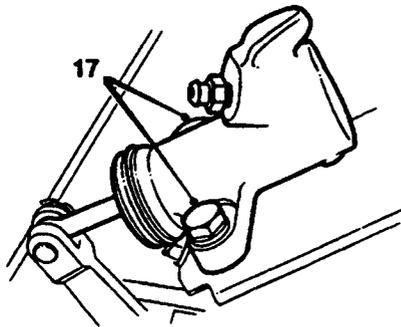

33M0092

15. Remove bolts and washers securing slave cylinder to mounting bracket, move cylinder aside.

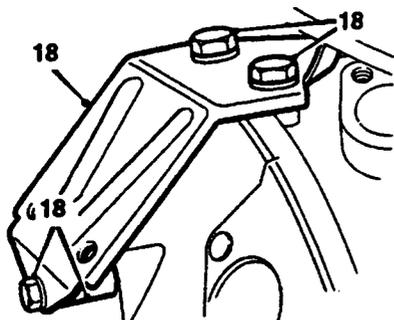

33M0093

16. Remove bolts and washers securing slave cylinder mounting bracket, remove bracket and collect spacer.

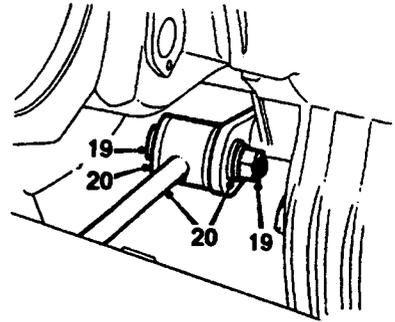

33M0094

17. Remove nut and bolt securing lower tie rod to transmission.
18. Remove tie rod washers, move tie rod aside.
19. Support power unit on a jack, use rubber pad or block of wood to protect sump.

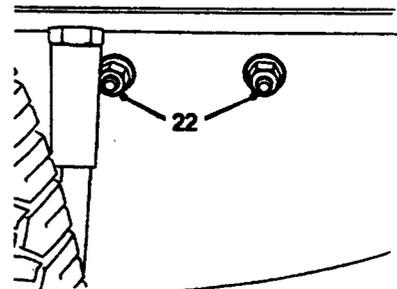

33M0095

20. Remove 2 nuts and washers securing engine RH mounting to body.
21. Raise power unit.

CLUTCH

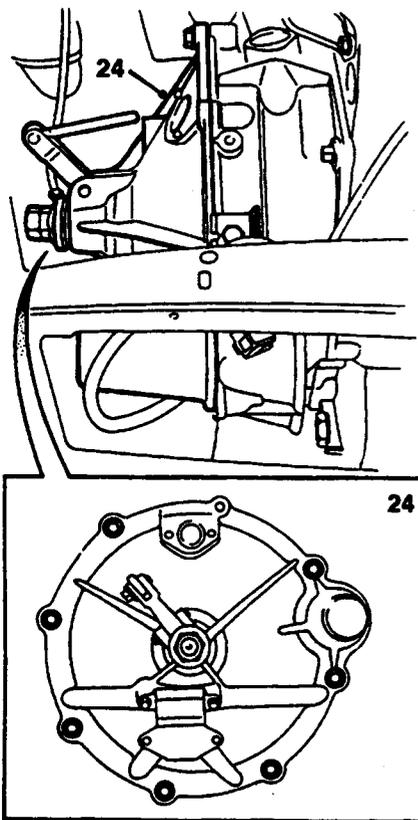

33M0096

22. Remove 7 bolts and washers securing clutch cover. Note fitted position of carburettor drain tube.
23. Lower power unit, manoeuvre clutch cover out between brake master cylinder and engine.

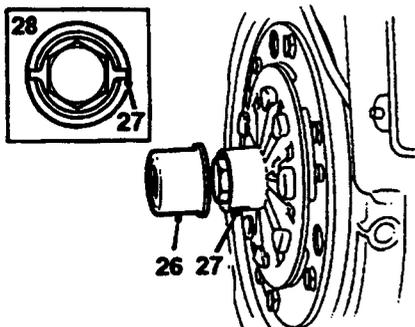

33M0097

24. Remove thrust sleeve from clutch hub.
25. Prise lock washer from clutch hub slots.
26. Rotate crankshaft until clutch hub slots are horizontally and lock flywheel.

CAUTION: If crankshaft is not positioned correctly, primary drive 'C' shaped washer may become displaced and make it impossible to remove flywheel.

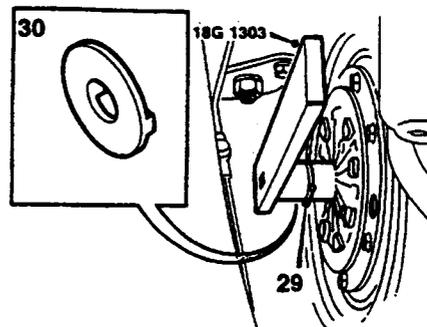

33M0098

27. Remove flywheel retaining bolt using 18G 1303.
28. Remove key plate from crankshaft.

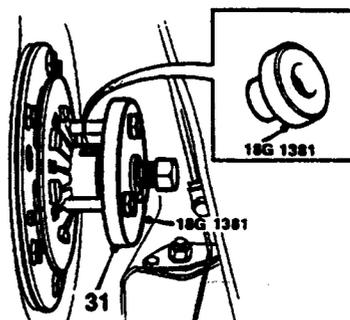

33M0099

29. Release flywheel from crankshaft using 18G 1381, remove tool and withdraw flywheel and clutch as an assembly.

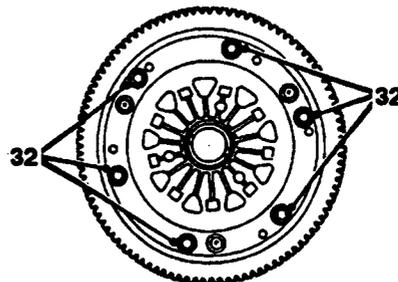

33M0100

30. Remove 6 pressure plate bolts.
31. Lift off pressure plate assembly.
32. Remove clutch plate from flywheel.

Inspection

33. Renew clutch plate if centre hub splines are worn or if linings are oil contaminated, burned or worn.
34. Check diaphragm spring for wear and fractures. Renew flywheel and pressure plate as an assembly if either component shows signs of wear or damage.

Refit

35. Check crankshaft primary gear end - float, see **MANUAL GEARBOX**.

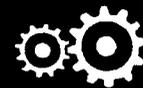

36. Fit clutch plate with hub boss facing flywheel, fit pressure plate and lightly tighten bolts.

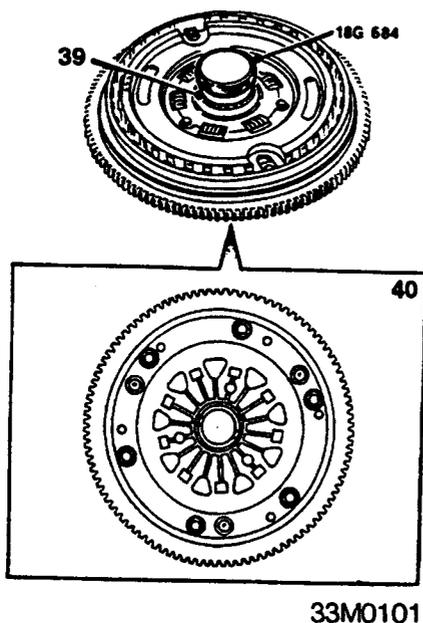

37. Using **18G 684**, centralise clutch plate
 38. Tighten pressure plate bolts to 25Nm. Remove **18G 684**.
 39. Fit flywheel and pressure plate assembly onto crankshaft.
 40. Fit key plate and new flywheel retaining bolt.
 41. Tighten flywheel retaining bolt to 152Nm using **18G 1303**.
 42. Stake lock washer into slots in clutch hub.
 43. Fit thrust sleeve to clutch hub.
 44. Remove flywheel locking tool.
 45. Reverse procedure given in 1 to 19; adjust throw - out stop after slave cylinder has been fitted, see **Adjustments**.

CLUTCH PLATE - SPI MODELS

Service Repair No. 33.10.02

Remove

1. Disconnect battery earth lead.
2. Raise front of vehicle.

WARNING: Support on safety stands.

3. Remove bonnet, see **BODY**
4. Remove front grille.
5. Release 3 turnbuckles and remove ignition shield.
6. Remove air cleaner, see **MODULAR ENGINE MANAGEMENT SYSTEM. - SPI.**
7. Remove ECU, see **MODULAR ENGINE MANAGEMENT SYSTEM. - SPI.**

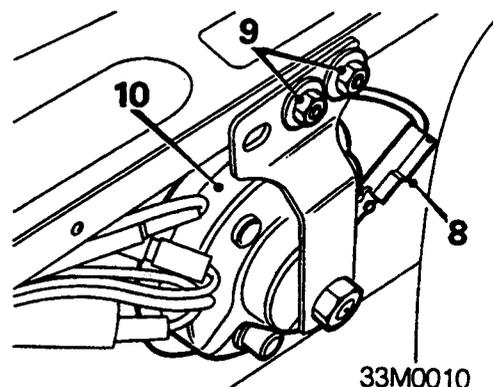

8. Disconnect Lucar from horn.
9. Remove 2 nuts securing horn.
10. Remove horn.

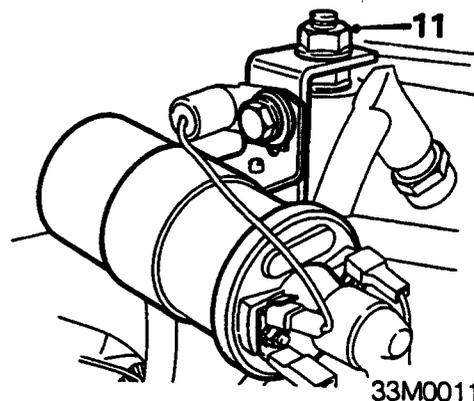

11. Remove nut securing ignition coil, move coil aside.

CLUTCH

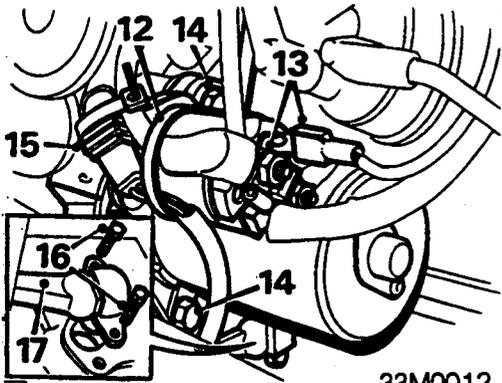

33M0012

12. Remove tie securing cables to starter solenoid.
13. Disconnect leads from starter solenoid.
14. Remove 2 bolts securing starter motor to engine, remove starter motor.
15. Disconnect crankshaft sensor multiplug.
16. Remove 2 screws, crankshaft sensor to flywheel housing.
17. Remove crankshaft sensor.

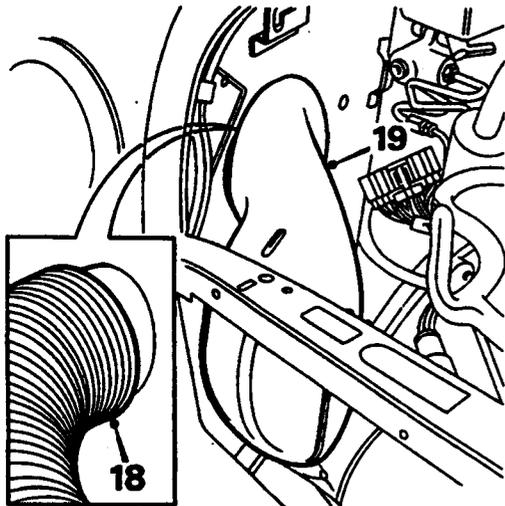

33M0013

18. Disconnect fresh air intake hose from duct under R.H. front wing.
19. Release and remove fresh air duct from valance.

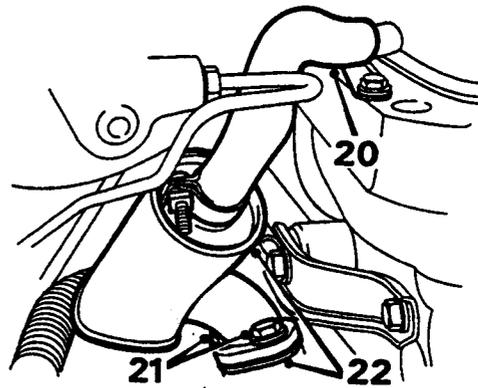

33M0014

20. Disconnect breather hose from pipe on cylinder head.
21. Remove 2 bolts securing breather separator to flywheel housing.
22. Remove breather separator and gasket.

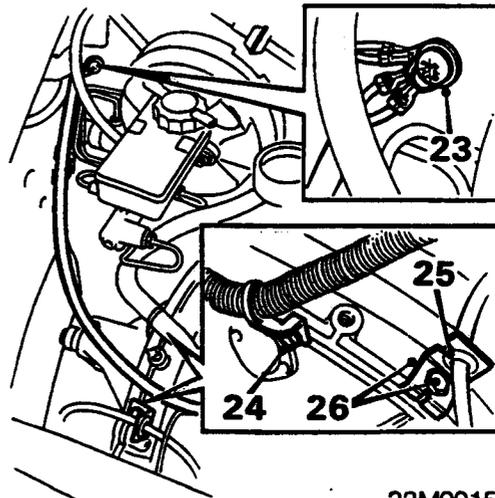

33M0015

23. Remove screw securing earth leads to body.
24. Remove bolt securing harness clip bracket to clutch housing, move harness aside.
25. Release starter cable grommet from bracket and move cable aside.
26. Remove bolt securing grommet bracket to flywheel housing, remove bracket.

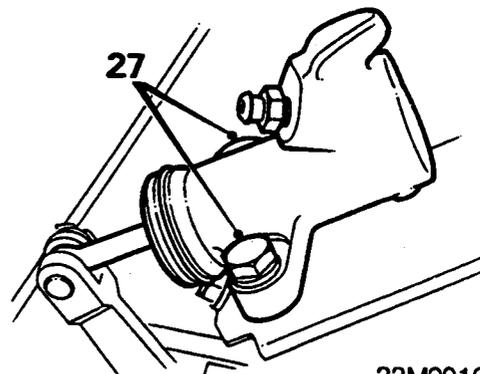

33M0016

27. Remove 2 bolts securing slave cylinder to bracket, withdraw slave cylinder from push rod, move slave cylinder aside.

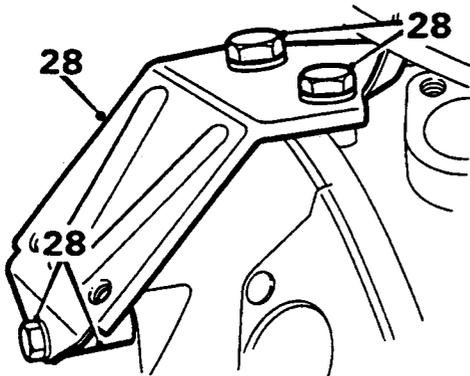

33M0017

28. Remove 3 bolts securing slave cylinder bracket to clutch housing, remove bracket and spacer.

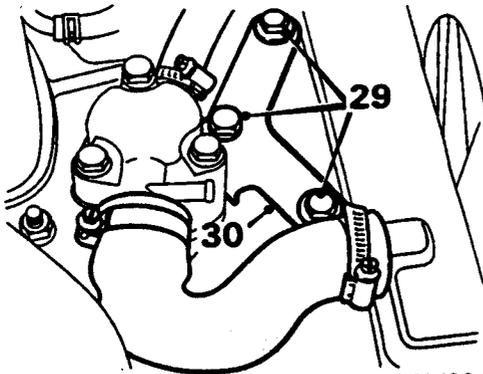

33M0018

29. Remove 3 bolts securing radiator top bracket.
30. Remove bracket.

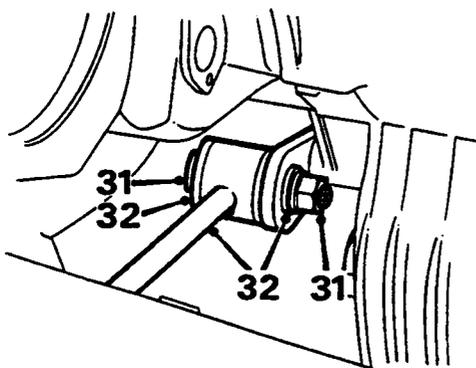

33M0019

31. Remove nut and bolt securing engine lower tie rod to transmission.
32. Remove tie rod washers, move tie rod aside.
33. Support power unit on jack.

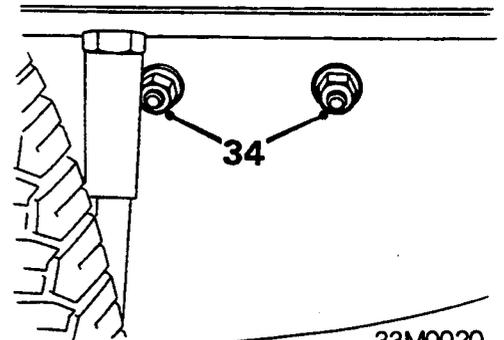

33M0020

34. Remove 2 nuts and bolts securing engine RH mounting.
35. Raise power unit.

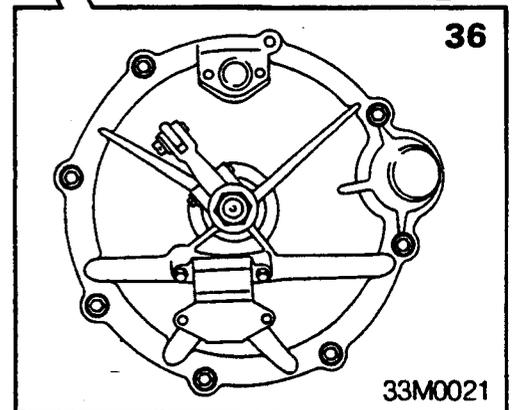
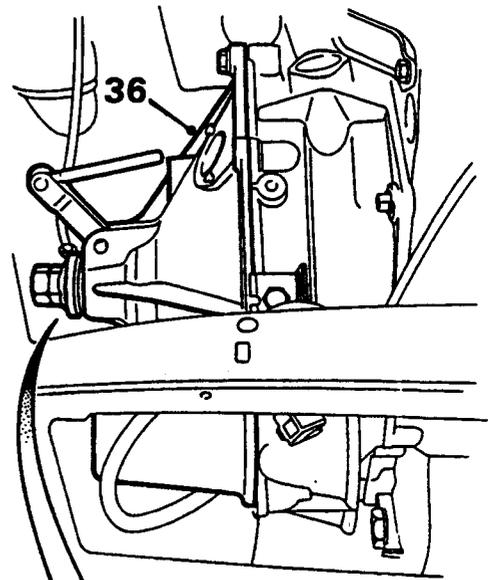

33M0021

36. Remove 7 bolts securing clutch cover, release cover.
37. Lower power unit, manoeuvre clutch cover out between brake master cylinder and engine.

CLUTCH

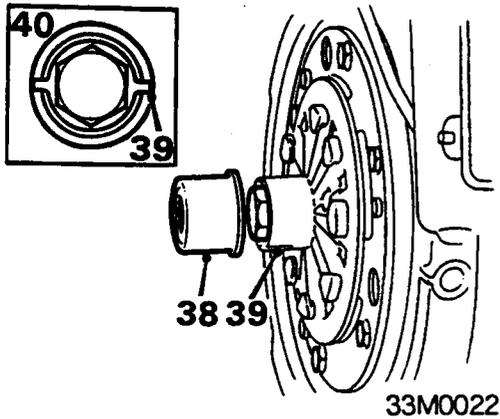

33M0022

38. Remove thrust sleeve from clutch hub.
39. Prise lock washer from clutch hub slots.
40. Rotate crankshaft until slots are horizontal, lock flywheel.

CAUTION: If crankshaft is not positioned correctly, primary drive 'C' shaped washer may become displaced and make flywheel removal impossible.

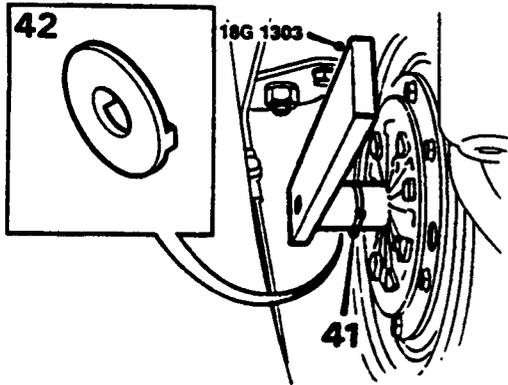

33M0023

41. Remove flywheel retaining bolt, using tool 18G 1303.
42. Remove key plate from crankshaft.

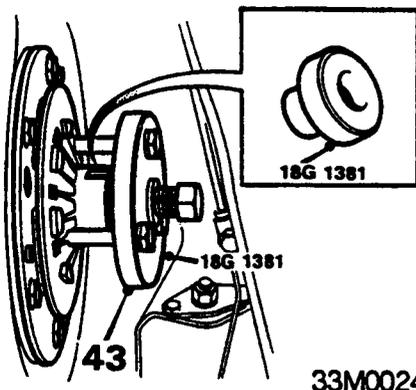

33M0024

43. Release flywheel from crankshaft, using tool 18G 1381.
44. Remove flywheel and clutch assembly.

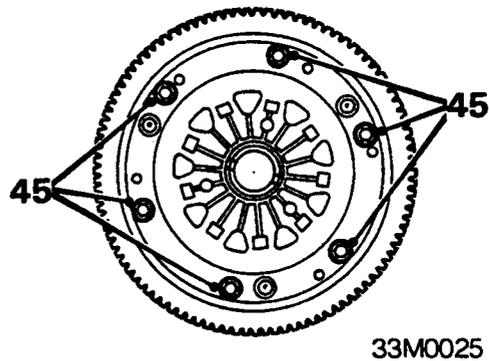

33M0025

45. Remove 6 pressure plate bolts.
46. Remove pressure plate.
47. Remove clutch plate.

Refit

48. Clean flywheel, pressure plate and crankshaft.
49. Fit clutch plate, hub boss towards flywheel, fit pressure plate, lightly tighten bolts.

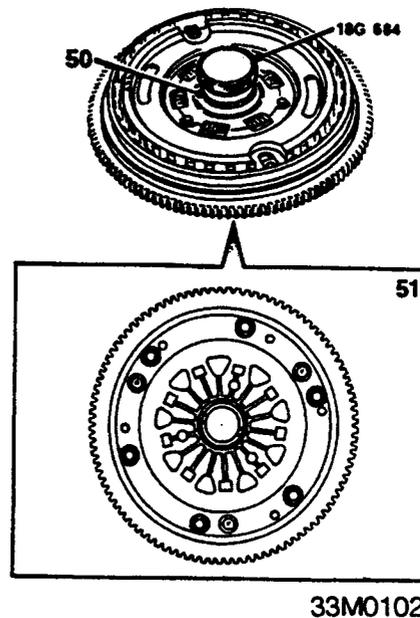

33M0102

50. Centralize clutch plate, using tool 18G 684.
51. Tighten pressure plate bolts to 25 Nm. Remove centralizing tool.
52. Fit flywheel and clutch assembly to crankshaft.
53. Fit key plate and new flywheel retaining bolt.
54. Tighten flywheel retaining bolt to 152 Nm. and stake lock washer into clutch hub slots.
55. Fit thrust sleeve to clutch hub.
56. Remove flywheel locking tool.
57. Slightly raise power unit.
58. Manoeuvre clutch cover into position, fit and tighten clutch cover bolts.
59. Lower power unit, fit and tighten engine mounting nuts and bolts.
60. Remove jack.

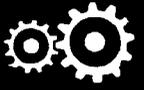

61. Fit lower tie rod bolt and washers, tighten bolt.
62. Fit radiator top bracket, fit and tighten bolts.
63. Fit slave cylinder bracket and spacer to clutch housing, fit and tighten bolts.
64. Fit slave cylinder to push rod and bracket, fit and tighten bolts.
65. Adjust throw - out stop, see **Adjustments**.
66. Fit grommet bracket to flywheel housing, fit and tighten bolt.
67. Fit starter cable grommet to bracket.
68. Fit harness clip bracket to clutch housing, fit and tighten bolt.
69. Fit and tighten screw securing earth leads to body.
70. Clean breather separator mating faces, fit separator and gasket, fit and tighten bolts.
71. Connect breather hose to pipe on cylinder head.
72. Fit fresh air duct to valance.
73. Connect fresh air intake hose to duct under RH front wing.
74. Clean mating faces and fit crankshaft sensor.
75. Fit crankshaft sensor screws and tighten to 6 Nm.
76. Connect crankshaft sensor multiplug.
77. Fit starter motor.
78. Fit and tighten starter motor bolts to 37 Nm.
79. Connect leads to starter solenoid and fit tie to secure harness to solenoid.
80. Fit ignition coil, fit and tighten nut.
81. Fit horn, fit and tighten nuts.
82. Connect Lucar to horn.
83. Fit ECU, see **MODULAR ENGINE MANAGEMENT SYSTEM. - SPI.**
84. Fit air cleaner, see **MODULAR ENGINE MANAGEMENT SYSTEM. - SPI.**
85. Fit splash shield and secure turnbuckles.
86. Fit front grille.
87. Fit bonnet, see **BODY**
88. Remove stand(s) and lower vehicle.
89. Connect battery earth lead.

MANUAL GEARBOX

CONTENTS

DESCRIPTION AND OPERATION

	Page
Gearbox components	2
Primary drive gear train	4

REPAIRS

	Page
Gear lever	1
Gear - change remote control	1
Gearbox assembly	2
Gearbox overhaul	3
Primary drive gear train	11
Third motion shaft - Overhaul	13
First motion shaft - Overhaul	14
Speedometer drive gear	16
Speedometer drive gear pinion	17
Speedometer drive housing	17



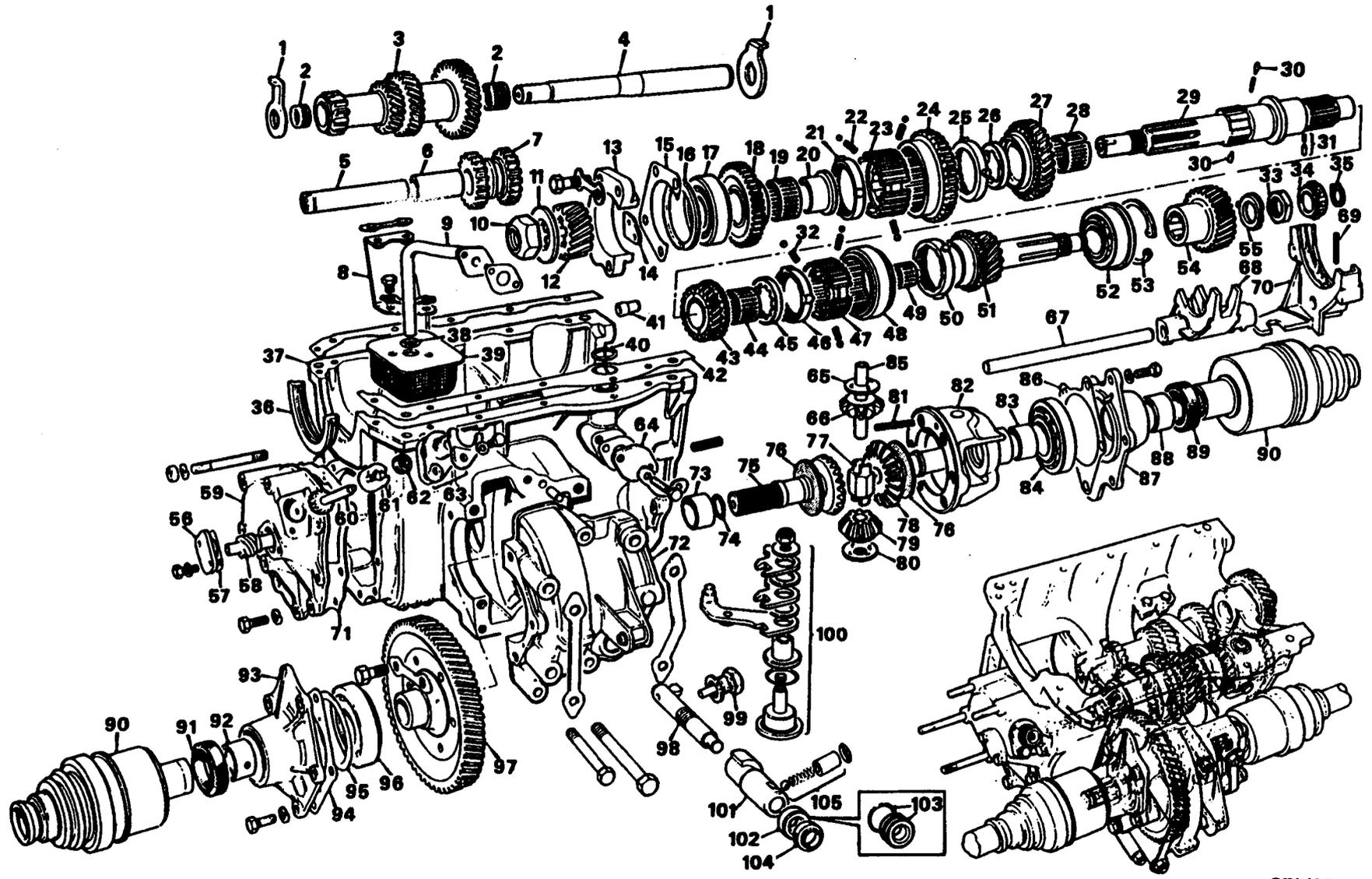

37M0344

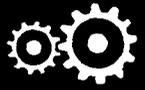

Gearbox components

- | | |
|--|--|
| 1. Laygear thrust washers | 54. First motion shaft gear |
| 2. Needle – roller bearings | 55. Lock plate |
| 3. Laygear | 56. End plate |
| 4. Layshaft | 57. Gasket |
| 5. Reverse idle gear shaft | 58. Speedometer gear |
| 6. Reverse idle gear bush | 59. Speedometer drive housing |
| 7. Reverse idle gear | 60. Speedometer pinion |
| 8. Oil strainer bracket | 61. Speedometer pinion bush |
| 9. Oil suction pipe | 62. Seal |
| 10. Third motion shaft nut | 63. Speedometer pinion housing and clamp |
| 11. Lock washer | 64. Blanking plate |
| 12. Final drive pinion | 65. Thrust washer |
| 13. Bearing retainer | 66. Differential pinion |
| 14. Reverse shaft locking plate | 67. Selector shaft |
| 15. Shim | 68. First/second speed selector fork |
| 16. Circlip | 69. Roll pin |
| 17. Bearing | 70. Third/fourth speed selector fork |
| 18. First speed gear | 71. Gasket |
| 19. Needle – roller bearing | 72. Differential housing |
| 20. Needle – roller bearing journal | 73. Bush |
| 21. Baulk ring | 74. Spring ring |
| 22. Synchronizer balls and springs | 75. Differential gear |
| 23. First/second speed synchronizer hub | 76. Thrust washer |
| 24. Reverse gear and first/second speed sliding coupling | 77. Differential thrust block |
| 25. Baulk ring | 78. Differential gear |
| 26. Rear thrust washer | 79. Differential pinion |
| 27. Second speed gear | 80. Thrust washer |
| 28. Split needle – roller bearing | 81. Roll pin |
| 29. Third motion shaft | 82. Differential cage |
| 30. Locking plungers and spring | 83. Bush |
| 31. Locking plunger and spring | 84. Bearing |
| 32. Synchronizer balls and springs | 85. Differential pinion pin |
| 33. First motion shaft nut | 86. Gasket |
| 34. First motion shaft spigot bearing | 87. Differential end cover |
| 35. Circlip | 88. Bush |
| 36. Main bearing cap oil seal | 89. Oil seal |
| 37. Gearbox case | 90. Inboard joint |
| 38. 'O' ring | 91. Oil seal |
| 39. Oil strainer | 92. Bush |
| 40. 'O' ring | 93. Differential end cover |
| 41. Dowel | 94. Gasket |
| 42. Gasket | 95. Shim |
| 43. Third speed gear | 96. Bearing |
| 44. Needle – roller bearing | 97. Final drive gear |
| 45. Thrust washer | 98. Selector shaft |
| 46. Baulk ring | 99. Drain plug |
| 47. Third/fourth speed synchronizer hub | 100. Bellcrank lever assembly |
| 48. Third/fourth speed sliding coupling | 101. Interlock spool |
| 49. Needle – roller bearing | 102. Bush |
| 50. Baulk ring | 103. Bush with 'O' ring |
| 51. First motion shaft | 104. Selector shaft seal |
| 52. bearing | 105. Detent balls, spring, sleeve and 'O' ring |
| 53. Circlip | |

MANUAL GEARBOX

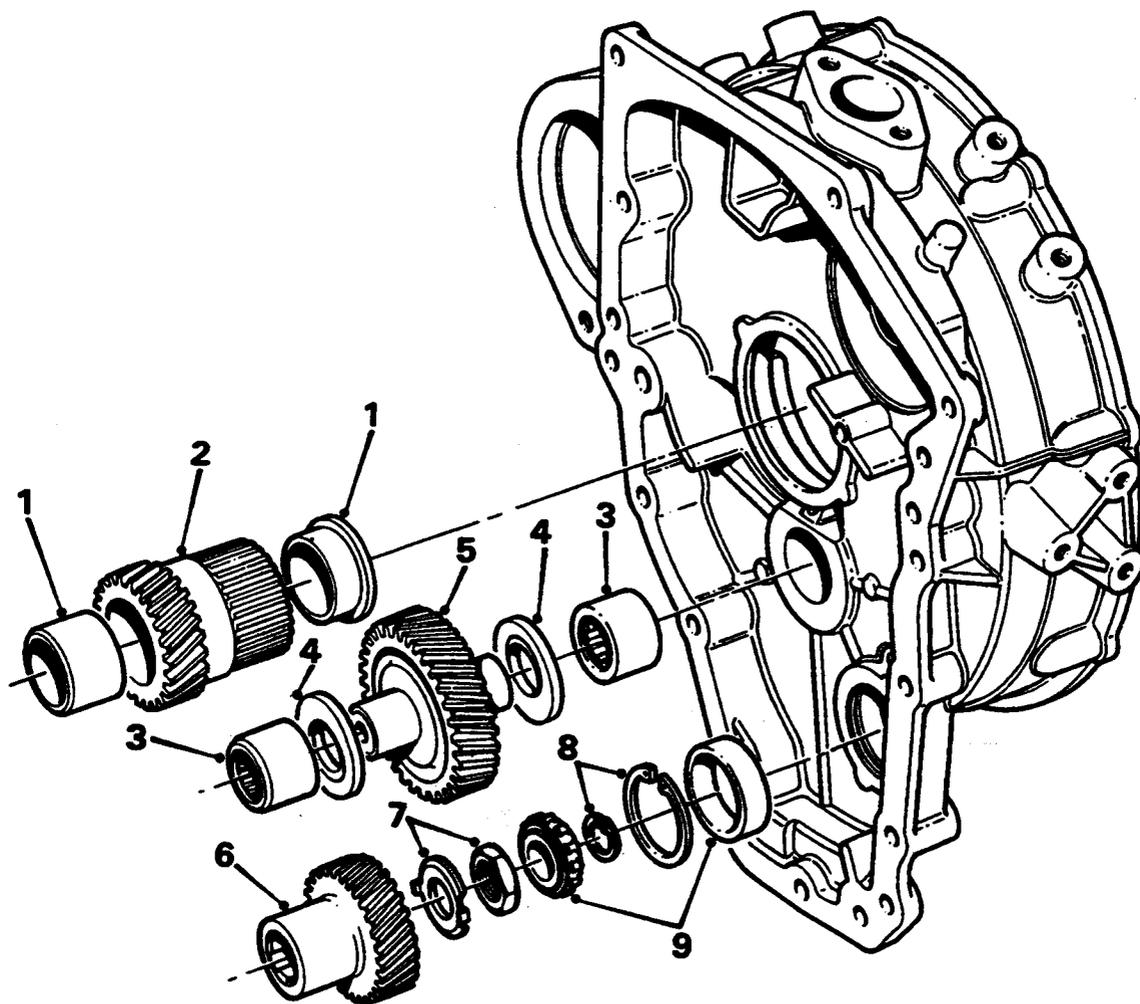

37M0345

Primary drive gear train

1. Primary gear bushes
2. Crankshaft primary gear
3. Needle - roller bearing
4. Thrust washer
5. Idler gear
6. First motion shaft gear
7. Nut and lock washer
8. Circlip
9. Spigot bearing

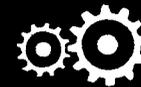

GEAR LEVER

Service Repair No. 37.16.04

Remove

If a console is fitted, remove console retaining screws to enable console to be moved as necessary.

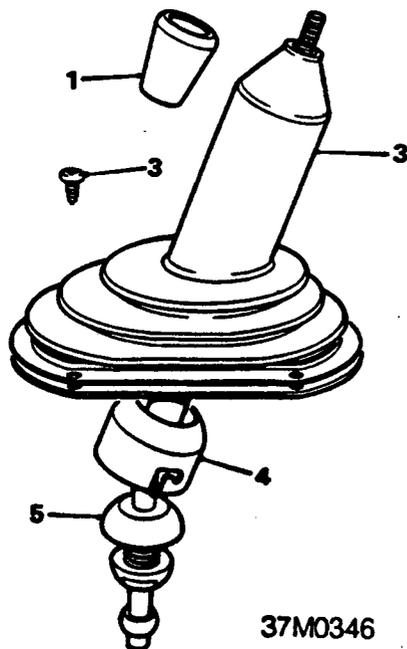

37M0346

1. Unscrew knob from gear lever.
2. Remove front floor covering.
3. Remove gaiter retaining ring screws and pull gaiter up the lever.
4. Press down and turn bayonet cap fixing to release the lever from remote control assembly.
5. Remove gear change lever.

Refit

6. Smear gear lever operating surfaces with Shell Alvania RA Grease or equivalent.
7. Reverse procedure in 1 to 5.

GEAR - CHANGE REMOTE CONTROL

Service Repair No. 37.16.19

Service Repair No. 37.16.25 - Rubber mountings

Remove

1. Drift out roll - pin retaining extension rod to selector shaft at differential housing.
2. Remove nut and bolt securing remote control steady rod to final drive housing on gearbox.
3. Fold back rear of front carpet and remove two nuts securing remote control mounting rubbers to floor.

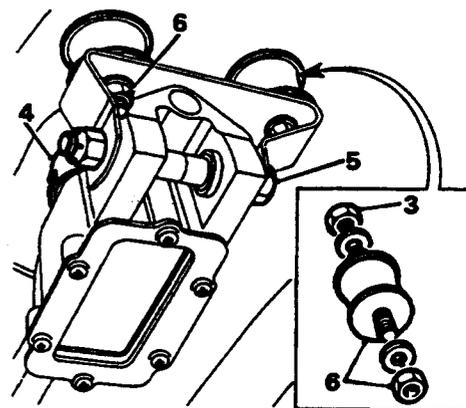

37M0347

4. Release gear lever from remote control from beneath car.
5. Remove one nut and bolt securing remote control housing to mounting bracket and remove bracket.
6. Remove nuts to release mounting rubbers from mounting bracket and remove remote control.

Refit

7. Reverse procedure in 1 to 6.

MANUAL GEARBOX

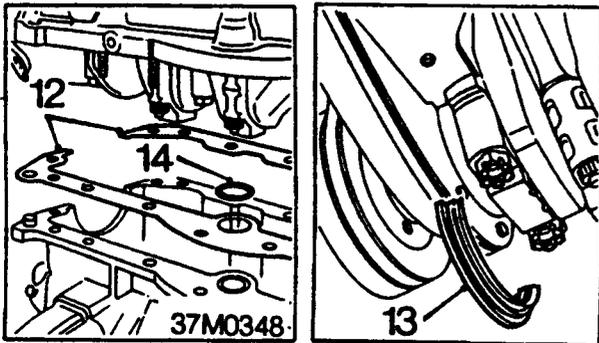
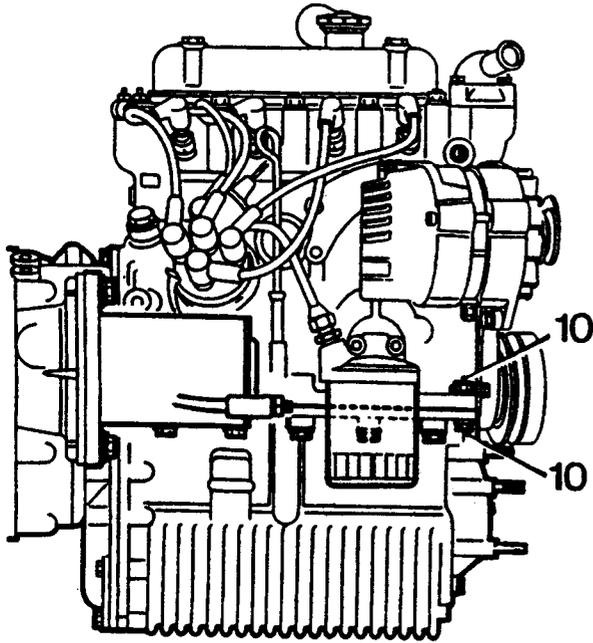
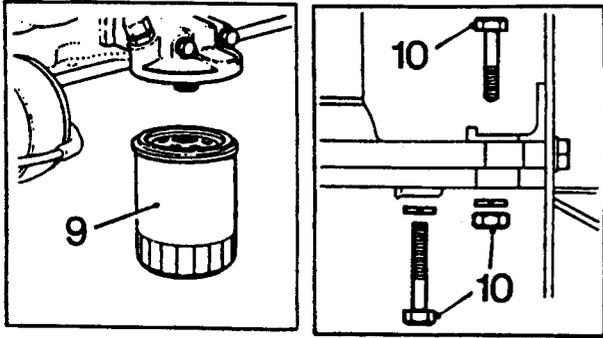

7. Remove two bolts retaining radiator to left - hand engine mounting bracket.
8. Unscrew and remove oil filter cartridge.
9. Remove all nuts, bolts and spring washers securing gearbox to engine.
10. Fit engine lifting equipment and lift engine away from gearbox.
11. Remove joint washers and ensure that joint faces are clean and free from burrs.
12. Remove front main bearing cap oil seal.

Refit

13. Fit new joint washers to transmission casing.
14. Lubricate and fit a new front main bearing cap oil seal to engine.
15. Check oil feed 'O' ring, and fit a replacement if necessary.
16. Lower engine onto transmission unit and tighten securing screws and nuts to 8Nm.
17. Fit a new joint washer to flywheel housing, refit the housing with new locking plates and torque tighten securing nuts and set screws:
 $\frac{3}{8}$ UNF to 35Nm
 $\frac{5}{16}$ UNF to 25Nm
18. Remove 18G 1043 from primary gear.
19. Refit clutch and flywheel, see **CLUTCH - Repairs**.
20. Refit clutch cover.
21. Refit bolts securing radiator to LH engine mounting bracket.
22. Refit starter motor.
23. Refit oil filter cartridge.
24. Refit engine/gearbox assembly, see **ENGINE - Repairs**.
25. Refill engine/gearbox with oil up to 'MAX' mark on dipstick see **INFORMATION - CAPACITIES, FLUIDS AND LUBRICANTS**.

GEARBOX ASSEMBLY

Service Repair No. 37.20.01

Remove

1. Drain engine/gearbox oil.
2. Remove engine/gearbox assembly, see **ENGINE - Repairs**.
3. Remove starter motor, see **ENGINE - Repairs**.
4. Remove clutch cover securing screws and lift off cover. see **CLUTCH - Repairs**.
5. Remove clutch and flywheel see **CLUTCH - Repairs**.
6. Remove flywheel housing, see **ENGINE - Repairs**.



GEARBOX OVERHAUL

Service Repair No. 37.20.04

Dismantle

1. Remove engine/gearbox assembly, see **ENGINE - Repairs**.
2. Remove gearbox from engine.

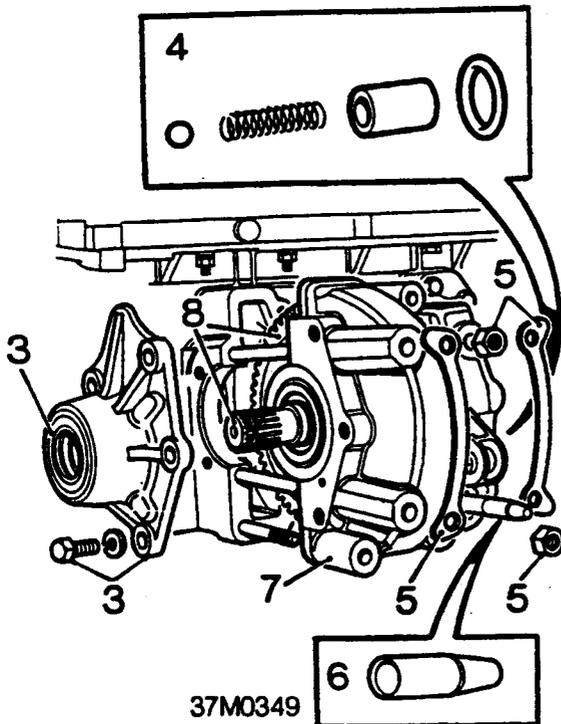

37M0349

3. Remove securing screws and detach final drive end covers.
4. Extract selector shaft detent spring, sleeve and ball, discard 'O' ring.
5. Knock back lock washer tabs and remove final drive housing bolts.
6. Locate oil seal protector sleeve **18G 1236** over the selector shaft.
7. Remove final drive housing; discard oil seal and remove bush, discard 'O' ring.
8. Remove final drive gear assembly.

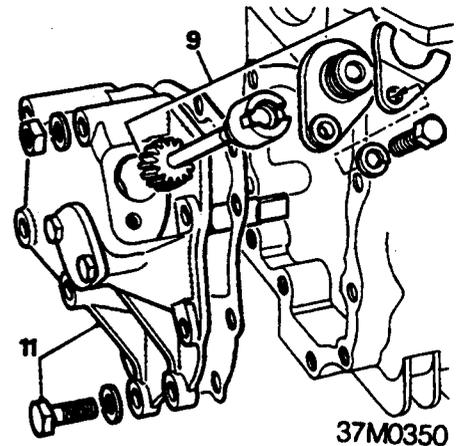

37M0350

9. Remove speedometer drive pinion.
10. Remove engine mounting adapter housing.
11. Remove speedometer drive housing.
12. Tap back lock washer tabs and remove screws securing oil suction pipe to gearbox casing; pull out pipe.

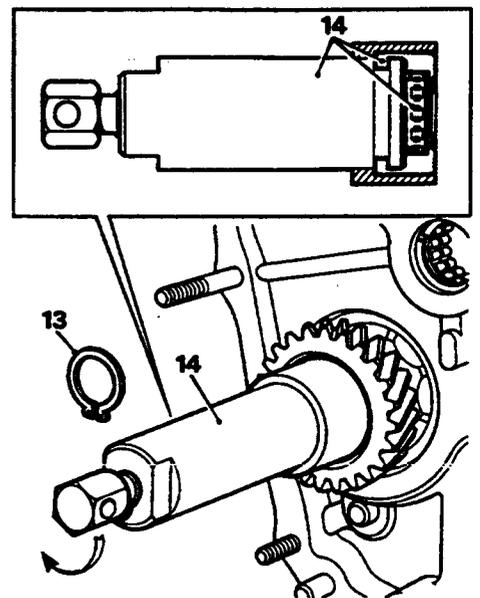

37M0351

13. Remove circlip retaining first motion shaft roller bearing, using **18G 1004**.

MANUAL GEARBOX

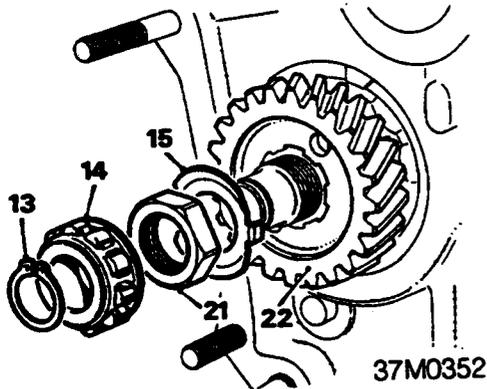

14. Use 18G 705 and 18G 705C to pull off first motion shaft roller bearing.
15. Knock back lock washer tab from first motion shaft securing nut.
16. Knock back lock washer tab from third motion shaft pinion gear securing nut.

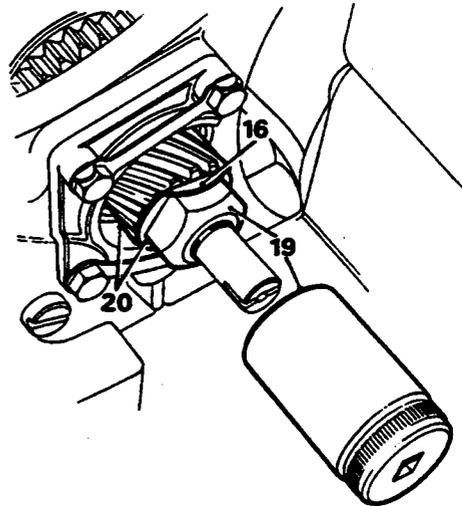

19. Use tool 18G 587 and remove third motion shaft final drive gear nut.

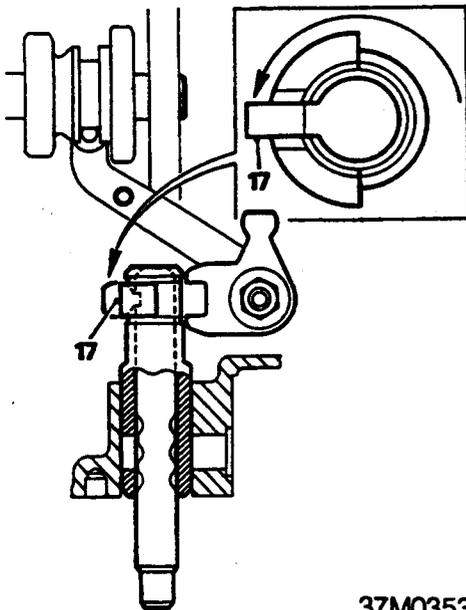

17. Rotate selector shaft anti-clockwise to disengage operating stub and interlock spool from bellcrank levers.
18. Engage first and fourth gears simultaneously to lock gear train.

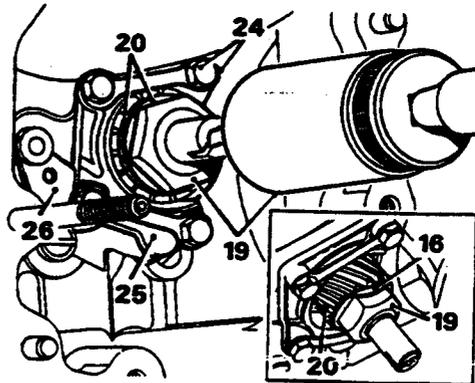

20. Pull off lock washer and final drive pinion.
21. Remove first motion shaft gear nut.
22. Pull off lock washer and first motion shaft gear.
23. Move first and fourth gears to neutral position.
24. Knock back lock washer tabs on third motion shaft bearing retainer bolts and remove bolts.
25. Remove retainer complete with adjustment shim(s).
26. Remove reverse locking plate.
27. Withdraw layshaft.

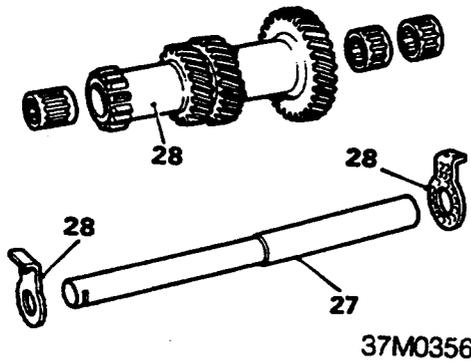
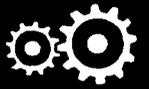

28. Take out small thrust washer from laygear, remove laygear and larger thrust washer.

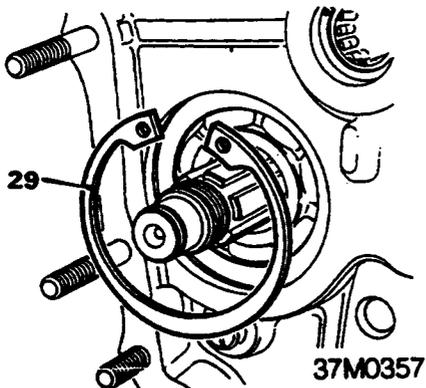

29. Use 18G 257 to remove first motion shaft bearing retaining circlip.

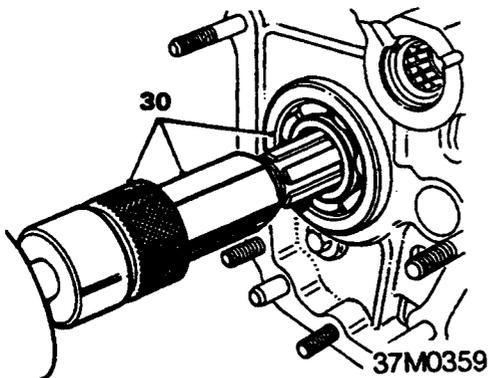

30. Use 18G 284 and 18G 284B and withdraw first motion shaft and bearing from end casing.

MANUAL GEARBOX

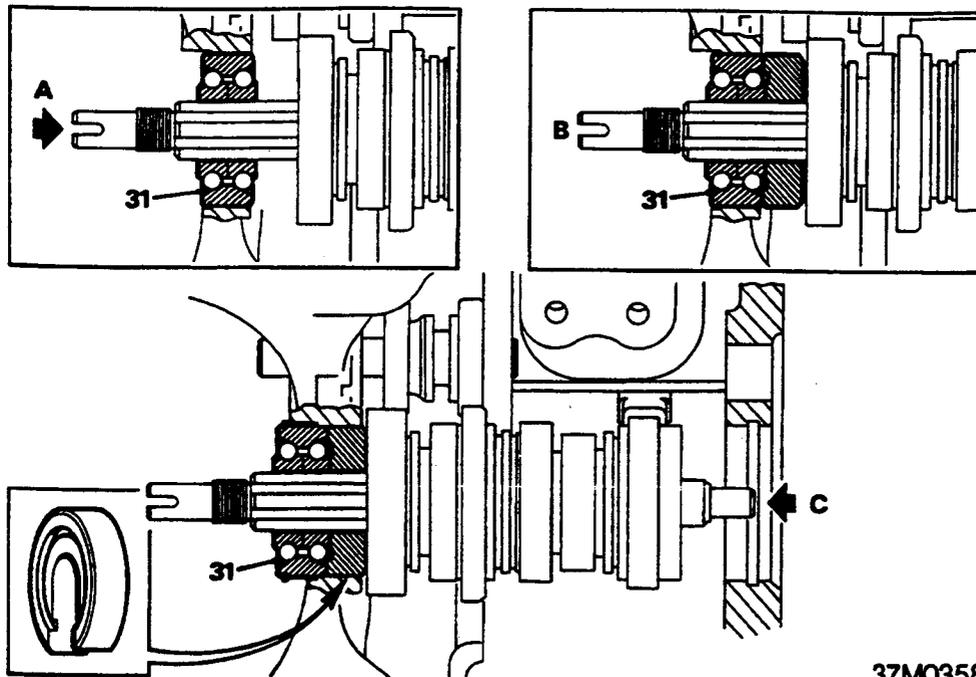

37M0358

31. Refer to removing procedure 'A', 'B' and 'C' on illustration to remove third motion shaft bearing.
- 'A': Use a soft drift and drift third motion shaft towards clutch end of gearbox. Take care not to disengage third fourth speed synchronizer from its hub as this would release its balls and springs.
- 'B': Insert 18G 1345 with its relieved side against the bearing.
- 'C': Drift other end of third motion shaft in opposite direction to remove third motion shaft bearing from centre web of casing.

Note: Should bearing not be completely removed from centre web by procedures given, it can be carefully levered out by using a screwdriver between casing and bearing circlip.

32. Lift out third motion shaft assembly.
33. Remove oil strainer.

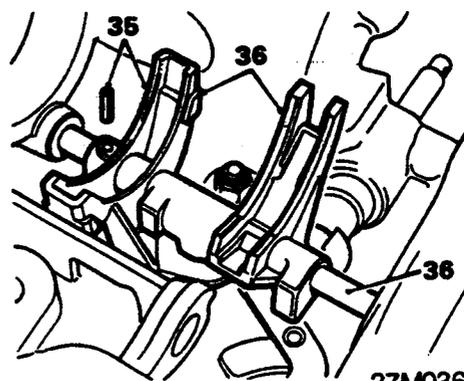

37M0361

35. Drift out roll - pin securing third/fourth speed selector fork to its shaft.
36. Remove selector shaft and forks.

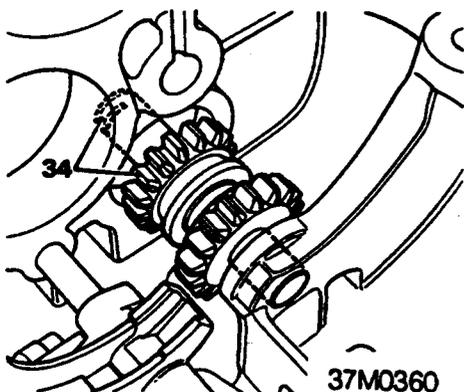

37M0360

34. Withdraw reverse idler shaft and gear.

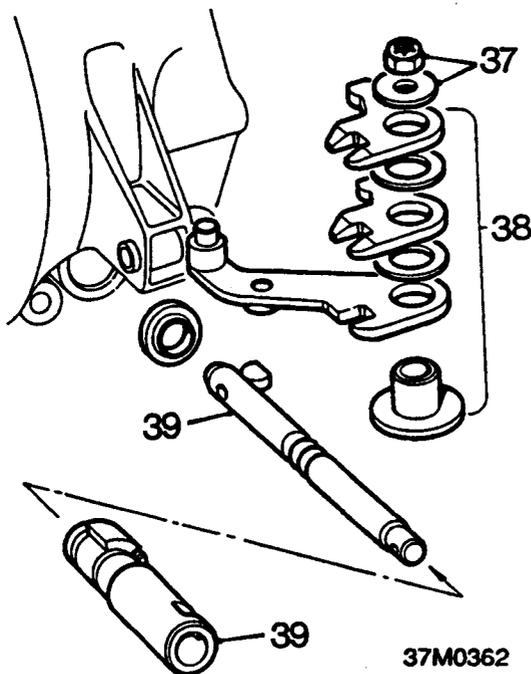
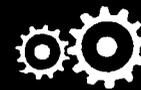

37. Remove bellcrank lever pivot post nut and washer.
38. Lift out bellcrank levers, washers and pivot sleeve.
Note location and markings on levers for reassembly.
39. Withdraw interlock spool and selector shaft from inside casing.

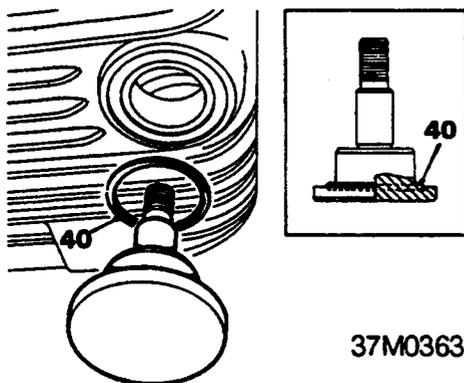

40. Drift bellcrank lever pivot post out of gearbox casing if 'O' ring is to be renewed.

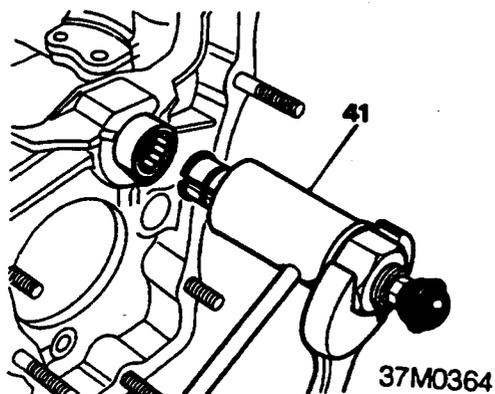

41. Remove idler gear bearing from gearbox casing, using 18G 581 or 18G 1288 as determined by bearing size.

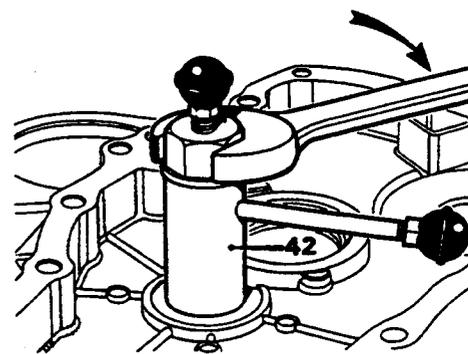

37M0365

42. Remove idler gear bearing from flywheel housing, using 18G 581 or 18G 1288 as determined by bearing size.

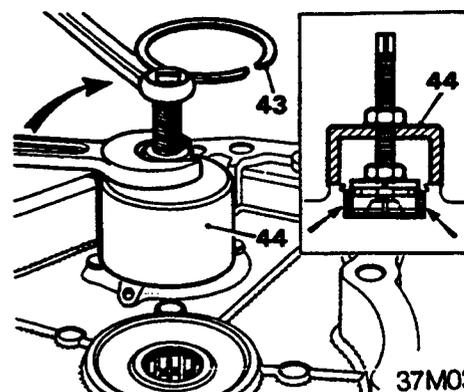

37M0366

43. Extract circlip retaining outer race of first motion shaft spigot bearing in flywheel housing.
44. Use 18G 617A to pull out outer race (arrowed).
45. Remove primary gear oil seal from flywheel housing.

Inspection

46. Clean all assemblies and examine for wear.
47. Completely dismantle main assemblies and thoroughly examine their components; refer to overhaul procedure for each main assembly given in reassembling procedure.

MANUAL GEARBOX

Reassemble

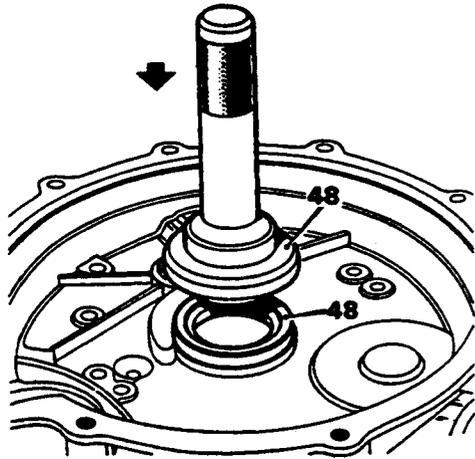

37M0367

48. Smear housing recess with Castrol LM grease and fit a new primary gear oil seal into flywheel housing, using 18G 134 and 18G 134BC.

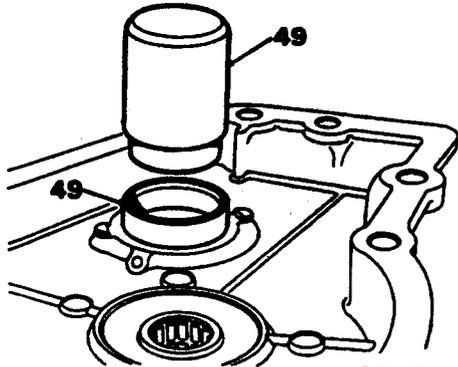

37M0368

49. Use 'replacer' part of 18G 617A and drift first motion shaft spigot bearing outer race into flywheel housing.
50. Refit bearing retaining circlip.

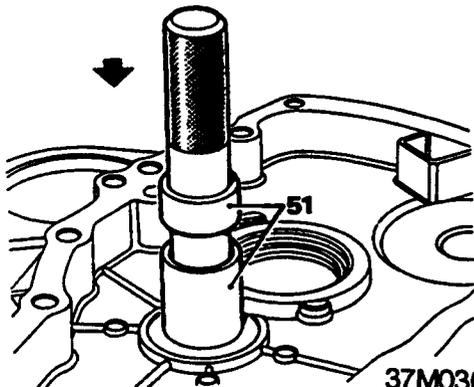

37M0369

51. Use 18G 1126 with its outer sleeve or 18G 1289 or 18G 1338, as determined by bearing size, and drift idler gear bearing into housing to depth governed by outer sleeve or shoulder of tool.

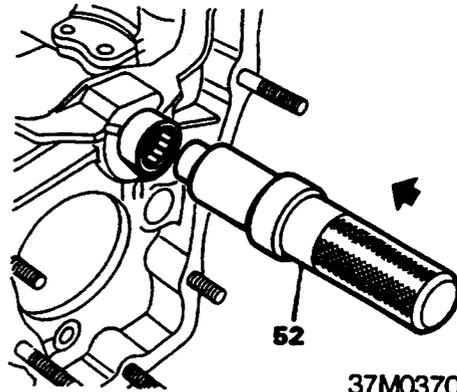

37M0370

52. Drift new idler gear bearing into gearbox casing, using 18G 1126 or 18G 1289 or 18G 1338 as determined by bearing size.

CAUTION: Do not drift bearing tight up against housing lip.

53. Lubricate and fit a new 'O' ring oil seal onto bellcrank lever pivot post and drift it into gearbox casing.
54. Insert selector shaft into interlock spool and refit assembly into gearbox with operating stub facing away from pivot post.
55. Refit sleeve, bellcrank levers (in their correct order) onto pivot post and tighten self-locking nut.

Note: DO NOT turn selector shaft and interlock spool into engagement with bellcrank levers until first and third motion shaft gear retaining nuts have been torque-tightened.

56. Refit third/fourth speed selector fork.
57. Refit first speed selector fork and drift selector rod through casing and forks; align hole in shaft with hole in third/fourth speed fork.
58. Drift in roll-pin until it is flush with fork.
59. Refit reverse idler gear into engagement with reverse bellcrank lever pivot and refit shaft.
60. Place oil strainer into its location in casing.
61. Dismantle and overhaul third motion shaft.
62. Dismantle and overhaul first motion shaft.
63. Insert third motion shaft assembly into gearbox and locate in the two selector forks.

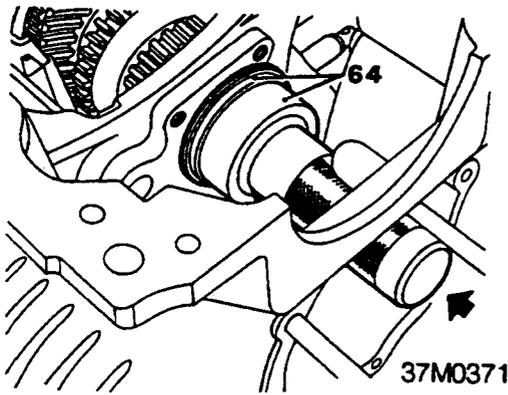
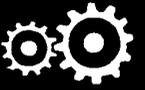

- 64. Use 18G 579 and drift third motion shaft bearing into centre web of casing.
- 65. Insert first motion shaft needle - roller bearing into its location in gear.

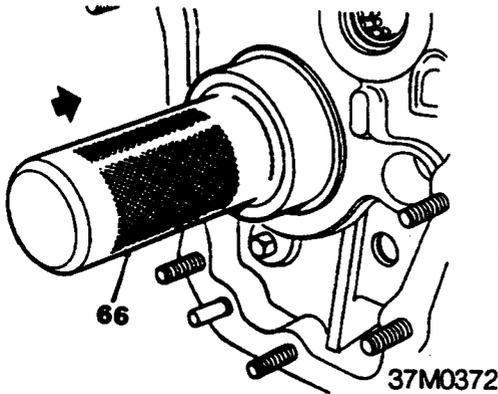

- 66. Drift first motion shaft assembly into casing, using 18G 579.

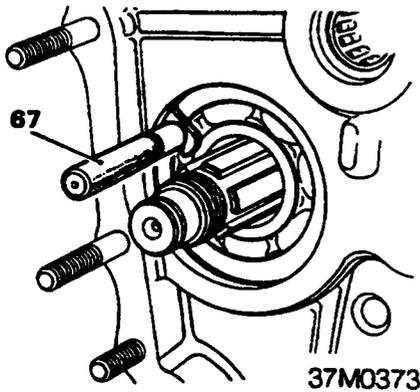

- 67. Use 18G 569 to gauge correct thickness circlip required - try thicker side of tool first; sizes are marked on handle.
- 68. Select correct circlip from chart given below and fit it using 18G 257.

When gap is
2.43 to 2.48 mm
2.48 to 2.54 mm

Use Circlip Part No.
2A 3710
2A 3711

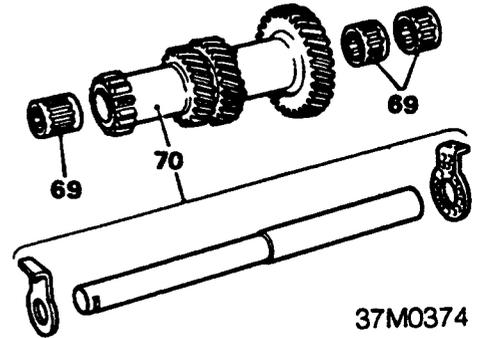

- 69. Insert needle - roller bearings into laygear.
- 70. Refit laygear and shaft with its thrust washers.

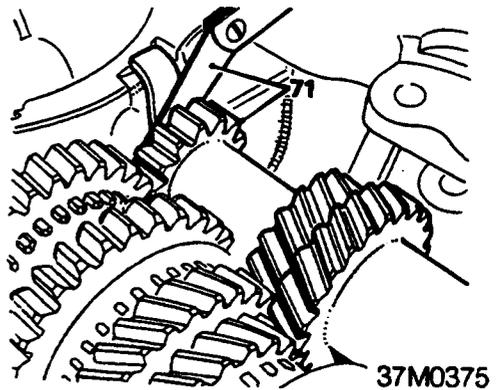

- 71. Use feeler gauges and check laygear end - float, which should be 0.05 to 0.15 mm. Select and fit required washer from chart given below:

Washer thickness

mm	Part No.
3.12 to 3.14	22G 856
3.17 to 3.20	22G 857
3.22 to 3.25	22G 858
3.30 to 3.32	22G 859

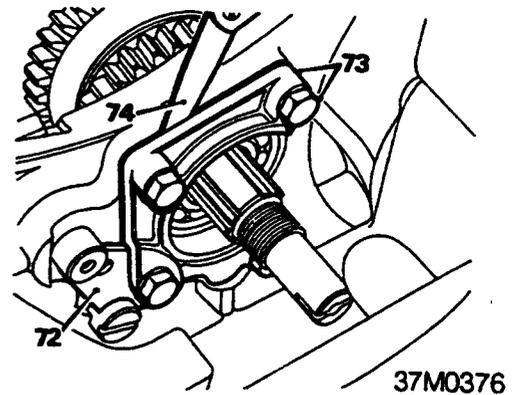

- 72. Refit layshaft and reverse shaft locking plate; turn the shafts if necessary until slots are correctly positioned.

MANUAL GEARBOX

73. Refit third motion shaft bearing retainer without any shims, lightly and evenly tighten retainer bolts.
74. Check gap with feeler gauges; select required thickness of shims from chart given below:
75. Refit gearbox to engine.
76. Refit engine/gearbox assembly see **ENGINE - Repairs.**

When gap is	Use shims totalling
0.13 to 0.15 mm	0.13 mm
0.15 to 0.20 mm	0.18 mm
0.20 to 0.25 mm	0.23 mm
0.25 to 0.30 mm	0.28 mm
0.30 to 0.35 mm	0.33 mm
0.35 to 0.38 mm	0.38 mm

75. Fit shims under layshaft and reverse shaft locking plate.
76. Refit bearing retainer with new lock washers, tighten the securing screws to 18Nm. Tap over lock washer tabs.
77. Engage first and fourth gears simultaneously to lock gear train.
78. Refit final drive pinion, a new lock washer and the securing nut onto third motion shaft.
79. Tighten final drive gear pinion nut, using **18G 587**, to 200Nm. Tap over lock washer tabs.
80. Refit first motion shaft gear with a new lock washer. Refit and tighten securing nut to 200Nm. Tap over lock washer tab.
81. Refit first motion shaft roller bearing and refit the retaining circlip with **18G 1004**.
82. Move first and fourth gears to neutral position.
83. Rotate selector shaft and interlock spool into engagement with bellcrank levers.
84. Insert oil suction pipe into strainer.
85. Fit a new joint washer and locking plates, tighten the external flange securing screws first, then pipe bracket screws. Tap over locking plate tabs.
86. Refit speedometer drive housing with a new joint washer to gearbox casing. Tighten securing nuts and screws to 25Nm.
87. Refit speedometer drive pinion with a new joint washer.
88. Refit engine mounting adapter housing.
89. Smear bush and 'O' ring with lithium based grease, fit bush and 'O' ring into the final drive housing.
90. Smear new oil seal with clean engine oil and fit oil seal to selector shaft.
91. After fitting seal, check that bush does not protrude beyond face of final drive housing.
92. Fit oil seal protector sleeve **18G 1236** over selector shaft then fit differential and housing taking care not to disturb nylon bush.
93. Adjust final drive gear assembly see **DIFFERENTIAL - Repairs.**
94. Refit selector shaft sleeve, ball and spring before fitting final drive end covers.

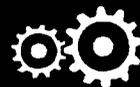

PRIMARY DRIVE GEAR TRAIN

Service Repair No. 37.20.10

Service Repair No. 37.20.11 Idler gear end - float - check and adjust

Remove

1. Remove clutch/flywheel, see **CLUTCH - Repairs**.
2. Remove flywheel housing, see **ENGINE - Repairs**.

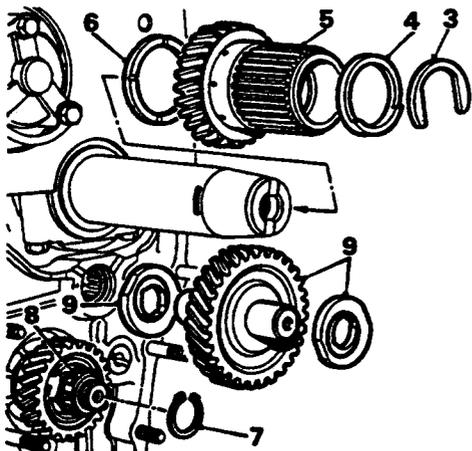

37M0377

3. Remove primary gear rear thrust washer.
4. Remove backing ring.
5. Pull off primary gear.
6. Remove primary gear front thrust washer.

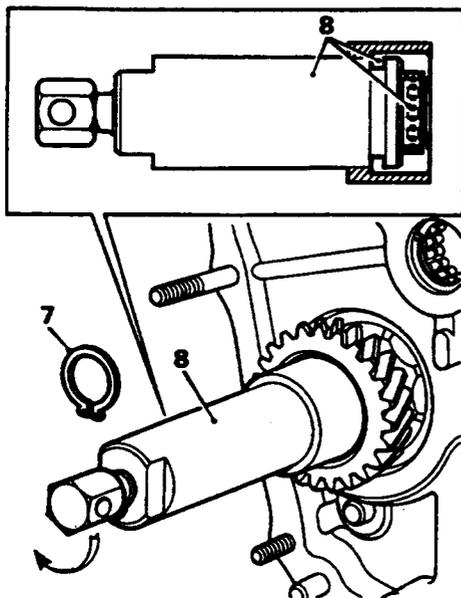

37M0378

7. Remove circlip retaining first motion shaft roller bearing, using 18G 1004.
8. Use 18G 705 and 18G 705C to pull off first motion shaft roller bearing.
9. Remove idler gear and thrust washers.

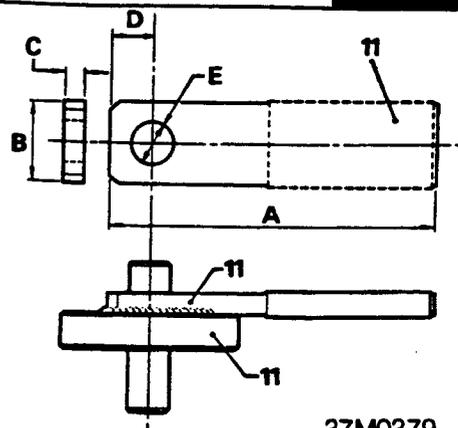

37M0379

10. Make up and use a tool to lock gear train while first motion shaft gear retaining nut is slackened. Make tool using an old idler gear and a piece of steel bar approximately 125 mm x 25 mm x 10 mm to dimensions given below:
 - A = 130 mm
 - B = 40 mm
 - C = 10 mm
 - D = 19 mm
 - E = 19 mm
11. Drill a 19 mm hole in bar as shown in illustration and arc-weld bar to a used idler gear. Wrap several thicknesses of tape around bar where it will contact crankshaft.

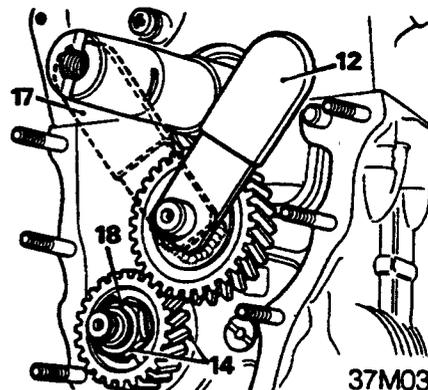

37M0380

12. Position tool into idler gear bearing with handle against crankshaft.
13. Knock back lock washer tab securing first motion shaft gear retaining nut.
14. Remove retaining nut and lift off first motion shaft gear.

Inspection

15. Examine all gears for undue wear or damage, and replace as a complete set if necessary. Check thrust washers and replace as required with those selected after checking idler gear and primary gear end - float.

MANUAL GEARBOX

Refit

16. Fit first motion shaft gear with a new lock washer.
17. Position gear train holding tool on opposite side of crankshaft.
18. Refit and tighten first motion shaft gear retaining nut to 200Nm.
19. Remove gear train holding tool.

Primary gear end - float

20. Refit primary gear with its front thrust washer, with chamfered side of washer (arrowed) towards crankshaft.
21. Refit rear backing and thrust washer.

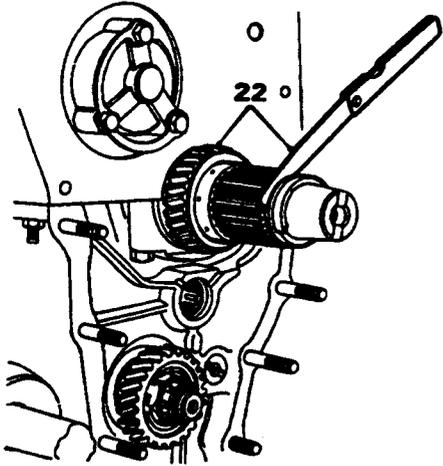

37M0381

22. Check primary gear end - float with feeler gauges; the amount of end - float should be from 0.10 to 0.18 mm. Adjust if necessary by fitting correct thickness thrust washer from range given below:

Primary gear thrust washer chart

- 2.84 to 2.89 mm
- 2.89 to 2.94 mm
- 2.94 to 2.99 mm
- 2.99 to 3.04 mm
- 3.04 to 3.09 mm

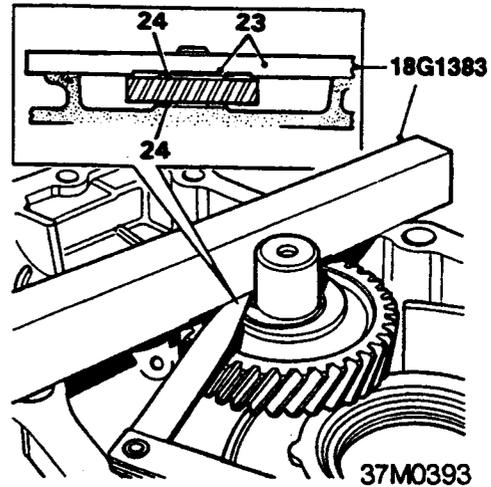

23. Fit idler gear to flywheel housing with a nominal sized thrust washer, 2.94 to 2.99 mm, on each side. Position 18G 1383 on flywheel housing with its recessed face downwards and measure gap between recessed face of tool and front thrust washer. Maintain original thickness of the front thrust washer if original gears are to be refitted. Select thrust washers to bring end - float within limits. Recheck end - float.
24. Oil thrust washers and fit idler gear and thrust washers as an assembly to gearbox casing.
25. Fit 18G 1043 over primary gear and screw two guides into two bottom holes in crankcase.
26. Refit flywheel housing see **ENGINE - Repairs**.
27. Refit clutch/flywheel see **CLUTCH - Repairs**.

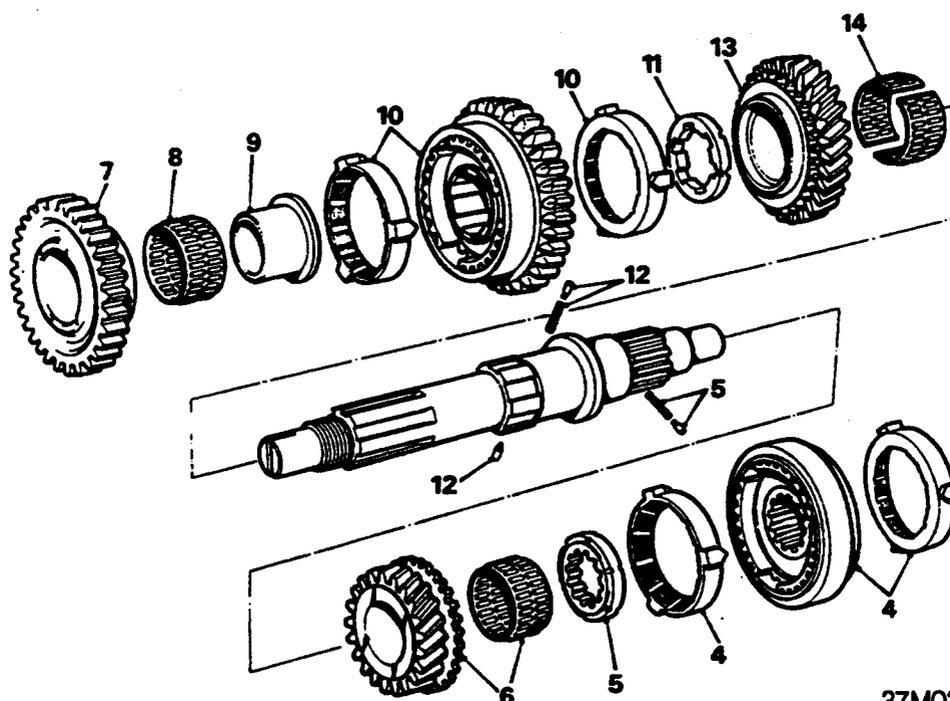
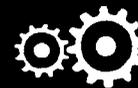

37M0382

THIRD MOTION SHAFT - OVERHAUL

Service Repair No. 37.20.31

Dismantle

1. Remove engine and gearbox assembly, see **ENGINE - Repairs**.
2. Remove gearbox from engine.
3. Remove third motion shaft from gearbox assembly.
4. Remove third/fourth speed synchronizer and baulk rings.
5. Depress front thrust washer plunger and turn washer until its splines register with those on shaft; remove thrust washer plunger and spring.
6. Remove third speed gear with its needle - roller bearing.
7. From other end of shaft, remove first speed gear.
8. Remove first speed gear needle - roller bearing.
9. Withdraw needle - roller bearing journal.
10. Remove combined reverse mainshaft gear and first/second speed synchronizer assembly with its baulk rings.
11. Depress two plungers securing rear thrust washer, turn it to align with shaft splines, and withdraw it from the shaft.
12. Remove two plungers and spring.
13. Remove second speed gear.
14. Remove second speed gear split caged needle - roller bearing.

15. Remove baulk rings from synchronizer assemblies.
16. Wrap a cloth around each synchronizer assembly to retain the balls and springs, push synchronizer hub from sliding coupling.

Inspection

17. Examine all gear teeth for excessive wear or damage.
18. Check third motion shaft bearing for excessive wear, pitting, security of cages and fit of bearing in gearbox casing.
19. Check two thrust washers for wear, and renew as necessary.
20. Examine baulk rings for wear; they should be checked with their mating tapers on gears. If baulk rings do not engage before they contact edge of gear, the hub and baulk rings must be renewed.
21. Check splines on third motion shaft for wear.
22. Examine the synchronizer balls and springs, and renew as necessary.

MANUAL GEARBOX

Reassemble

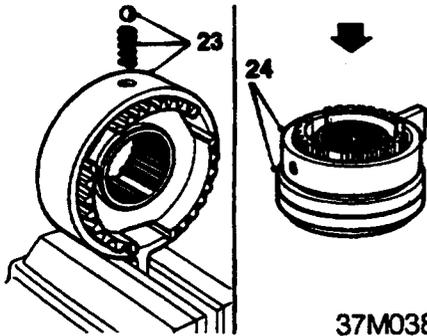

37M0383

23. Hold 18G 572 in a vice and reassemble each synchronizer hub to its respective coupling. Place the synchronizer hub into the tool, locate a spring and ball through the loading in the synchronizer hub. Press the ball and spring into the hub and turn it to the next loading position. Repeat this procedure with the other two balls and springs.

WARNING: Wear safety glasses when loading synchronizers. Always turn unit in same direction, otherwise a ball may be released and cause injury to operator.

24. Place synchronizer coupling on a flat surface with hub (still assembled in 18G 572 above it and with cut outs in alignment. Give hub a sharp tap with a hammer shaft to knock hub into coupling. Repeat this procedure on other synchronizer assembly.
25. Hold third motion shaft in a vice fitted with soft - faced jaws.
26. Refit second speed gear complete with its split - caged needle - roller bearing.
27. Insert plungers and spring into shaft; refit thrust washer with its machined grooves on underside into position. Push in both plungers simultaneously and push down on thrust washer until both plungers are engaged, then turn the thrust washer one spline to lock it in position.
28. Refit combined reverse mainshaft gear and first/second speed synchronizer assembly complete with baulk rings.
29. Refit first speed gear needle - roller bearing journal; use tool 18G 186 to drift it into shaft if it is a tight fit.
30. Refit first speed gear and needle - roller bearing.
31. Hold complete assembly together and reverse holding position of third motion shaft in vice whilst remaining components are assembled on opposite end.
32. Refit third speed gear and needle - roller bearing.
33. Repeat procedure in 22? to refit other thrust washer, except that it has only one retaining plunger.

34. Refit third/fourth speed synchronizer and baulk rings.
35. Fit third motion shaft to gearbox assembly.
36. Refit gearbox to engine.
37. Refit engine and gearbox assembly, see **ENGINE - Repairs.**

FIRST MOTION SHAFT - OVERHAUL

Service Repair No. 37.20.34

Dismantle

1. Drain engine and gearbox oil.
2. Remove engine and gearbox assembly, see **ENGINE - Repairs.**
3. Remove clutch and flywheel, see **CLUTCH - Repairs.**
4. Remove flywheel housing, see **ENGINE - Repairs.**

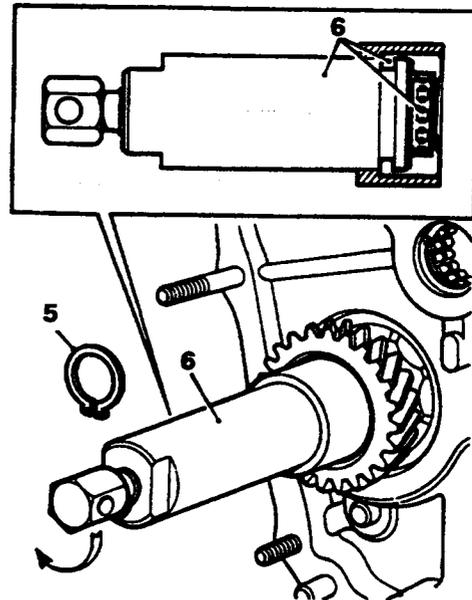

37M0384

5. Use 18G 1004 to remove first motion shaft roller bearing circlip.

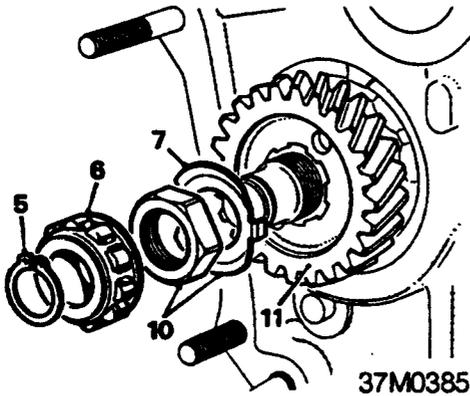
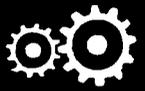

6. Use 18G 705 and 18G 705C to withdraw roller bearing off first motion shaft.
7. Knock back lock washer tab from first motion shaft securing nut.
8. Remove idler and primary gears.

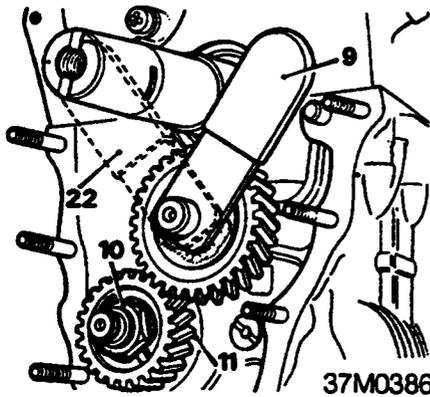

9. Fit primary gear train holding tool - see Primary Drive Gear Train for make-up details.
10. Remove first motion shaft gear securing nut and lock washer.
11. Pull off first motion shaft gear.

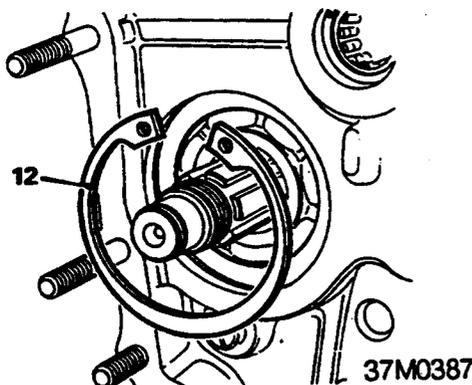

12. Use 18G 257 to remove circlip retaining first motion shaft bearing.

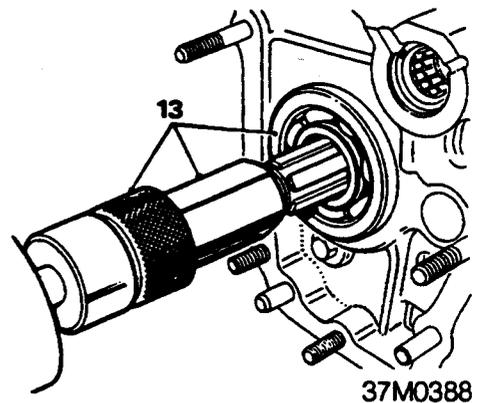

13. Use impact tool 18G 284 with adapter 18G 284B and withdraw first motion shaft assembly from gearbox casing.
14. Press first motion shaft out of bearing.

Inspection

15. Examine gear and baulk ring surfaces for undue wear.
16. Check first motion shaft bearing and internal needle-roller bearing for wear, and renew as necessary.

Reassemble

17. Press first motion shaft into bearing.
18. Lubricate internal needle-roller bearing and insert it into first motion shaft.
19. Locate baulk ring into third/fourth speed synchronizer hub.

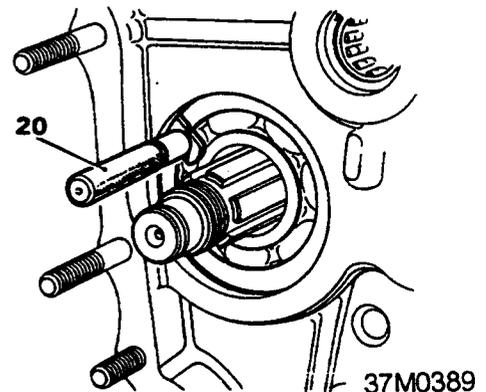

20. Drift first motion shaft assembly into casing, using 18G 579.
21. Use 18G 569 to gauge correct thickness circlip required - try thicker side of tool first; sizes are marked on handle.
22. Select correct circlip from chart given and fit it using 18G 257.

When gap is	Use circlip Part No.
2.43 to 2.48 mm	2A 3710
2.48 to 2.54 mm	2A 3711

23. Position primary gear train holding tool so that its handle is against opposite side of crankshaft.
24. Refit first motion shaft gear with a new lock washer. Refit and tighten securing nut to 200Nm.

25. Drift roller bearing onto first motion shaft and refit retaining circlip, using **18G 1004**.
26. Remove gear train holding tool and refit idler gear with its thrust washers; note that longer spindle of the gear locates in gearbox.
27. Refit crankshaft primary gear with its thrust washers and backing ring; check end - float, and adjust if necessary, see **ENGINE - Repairs**.
28. Refit flywheel housing, see **ENGINE - Repairs**.
29. Refit clutch/flywheel, see **CLUTCH - Repairs**.
30. Refit engine/gearbox assembly, see **ENGINE - Repairs**.
31. Refill engine/gearbox with oil up to 'MAX' mark on dipstick, see **INFORMATION - CAPACITIES, FLUIDS AND LUBRICANTS**.

SPEEDOMETER DRIVE GEAR

Service Repair No. 37.25.01

Remove

1. Remove engine/gearbox assembly see **ENGINE - Repairs**.
2. Remove bolts retaining radiator to engine mounting bracket.
3. Remove engine mounting bracket.

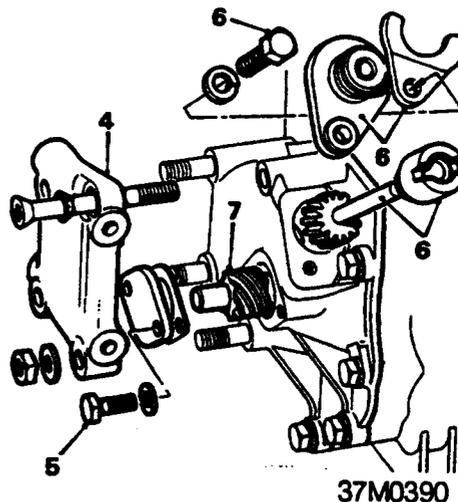

4. Remove adapter plate from speedometer drive housing.
5. Remove end plate securing screws and remove end plate and joint washer.
6. Remove securing screw and withdraw speedometer drive pinion and housing assembly.
7. Withdraw speedometer drive gear.

Refit

8. Reverse procedure in 2 to 7, fitting new joint washers where required.
9. Refit engine/gearbox assembly see **ENGINE - Repairs**.

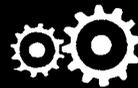

SPEEDOMETER DRIVE GEAR PINION

Service Repair No. 37.25.05

Remove

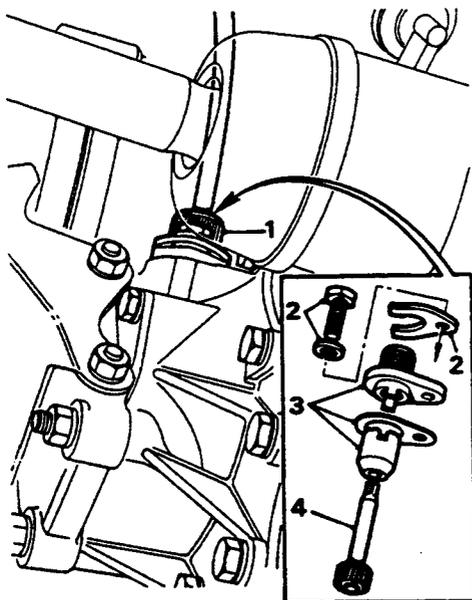

37M0391

1. Disconnect speedometer drive cable from pinion housing.
2. Remove screw, spring washer and retainer plate securing pinion housing.
3. Remove pinion housing assembly.
4. Pull out speedometer drive pinion.

Refit

5. Reverse procedures in 1 to 4, noting following:
 - Fit a new pinion housing joint washer.
 - Do not overtighten speedometer cable knurled connection.

SPEEDOMETER DRIVE HOUSING

Service Repair No. 37.25.09

Remove

1. Remove engine/gearbox assembly see **ENGINE - Repairs.**

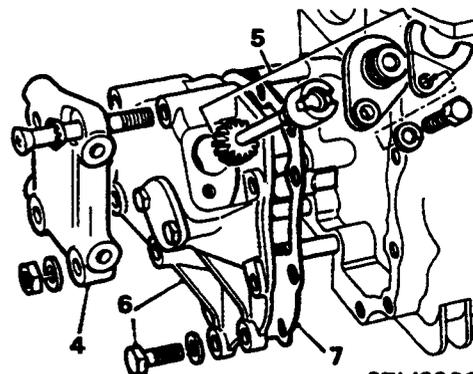

37M0392

2. Remove bolts retaining radiator to engine mounting bracket.
3. Remove engine mounting bracket.
4. Remove adapter plate from speedometer drive housing.
5. Remove speedometer drive pinion housing securing screw and withdraw drive pinion assembly.
6. Remove speedometer drive housing securing screws and withdraw housing.
7. Remove housing joint washer.

Refit

8. Reverse procedure in 2 to 7, fitting new joint washers where required.
9. Refit engine/gearbox assembly see **ENGINE - Repairs.**

AUTOMATIC GEARBOX

CONTENTS

Description and Operation	Page
Description	4
Mechanical system	4
Hydraulic system	5
Mechanical power flow diagrams	6
Line pressure and lubrication diagrams	12

Adjustments	Page
Service requirements	1
Examination of components	2
Test equipment	2
Road test procedure	3
Shift speeds	5
Selector cable adjustment	5
Kick - down linkage adjust	6
Check	6
Adjust	6
Starter inhibitor switch adjustment	7
Reverse light switch adjustment	7
Brake bands adjustment	8

Repairs	Page
Brake bands	1
Forward clutch	1
Top and reverse clutch	3
Forward clutch - overhaul	5
Top and reverse clutch - overhaul	7
First gear free - wheel assembly	9
Kick - down control	10
Selector mechanism assembly	11
Selector cable	13
Starter inhibitor switch	14
Converter housing	14
Converter housing oil seal	16
Converter assembly	16
Primary drive gears	18
Gearbox assembly	20
Gearbox assembly - overhaul	22
Governor housing assembly	29
Governor assembly - overhaul	32
Oil pump	33
Oil pump - overhaul	33
Servo assembly	34
Servo assembly - overhaul	36
Gear train	37
Speedometer drive pinion	39
Speedometer drive gear	39
Valve block assembly	40
Valve block assembly - overhaul	43



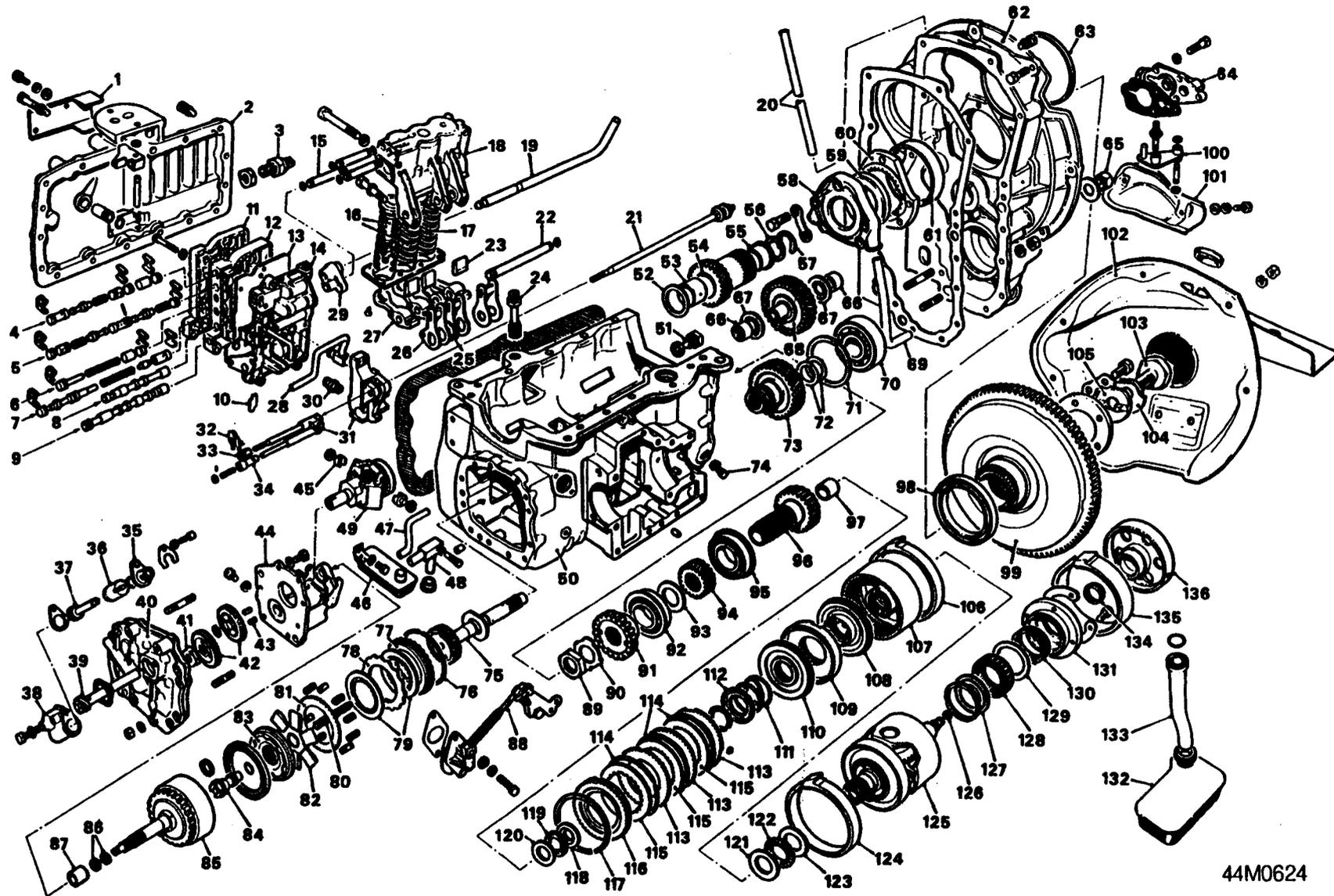

44M0624

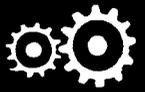

Automatic gearbox components

- | | | |
|--|--|-------------------------------------|
| 1. Inhibitor switch guard plate | 43. Roll pin | 92. Bearing |
| 2. Front cover | 44. Governor mounting plate | 93. Spacing washer |
| 3. Inhibitor switch | 45. Yoke | 94. Final drive pinion |
| 4. Reverse dump valve and third gear valve | 46. Oil strainer | 95. Bearing |
| 5. Top and second gear valves | 47. Pipe forward clutch | 96. Top and reverse clutch hub |
| 6. Engagement control pressure valve | 48. Oil suction pipe | 97. Bush |
| 7. Regulator valve | 49. Governor | 98. Oil seal |
| 8. Governor valve | 50. Gearbox case | 99. Converter |
| 9. Selector valve | 51. Drain plug | 100. Bellcrank lever |
| 10. Flap valve | 52. Front thrust washer | 101. Bellcrank lever cover |
| 11. Lid | 53. Front bush | 102. Converter cover |
| 12. Valve chest | 54. Converter output gear | 103. Converter retaining bolt |
| 13. Separator plate | 55. Rear bush | 104. Lock washer |
| 14. Pipe chest | 56. Backing ring | 105. Key plate |
| 15. Pipes - valve block to servos | 57. 'C' shaped thrust washer | 106. Second gear brake band |
| 16. Second and reverse gear servos | 58. Rear case | 107. Top and reverse clutch |
| 17. Third gear servo | 59. Oil seal | 108. Reverse gear booster piston |
| 18. Servo body | 60. Stator carrier | 109. Cylinder |
| 19. Pipe - converter to valve block | 61. Bush | 110. Top gear piston |
| 20. Dipstick tube | 62. Converter housing | 111. Piston return spring |
| 21. Transverse selector rod | 63. Oil pump cover | 112. Spring retainer |
| 22. Pivot shaft | 64. Low pressure valve | 113. Intermediate plates |
| 23. Strut | 65. Input gear nut | 114. Separation springs |
| 24. Adapter | 66. Idler gear bearing | 115. Clutch plates |
| 25. Pivot shaft washer | 67. Thrust washer | 116. End plate |
| 26. Reaction levers | 68. Idler gear | 117. Circlip |
| 27. Servo levers | 69. Pipe - converter to low pressure valve | 118. Thrust washer |
| 28. Valve block connector and pipe | 70. Bearing | 119. Needle - roller thrust bearing |
| 29. Guide - pipe assembly | 71. Retainer | 120. Thrust race washer |
| 30. Valve block connector | 72. Shims | 121. Thrust washer (thin) |
| 31. Park lock assembly | 73. Input gear | 122. Needle - roller thrust bearing |
| 32. Locking clip | 74. Dowel bolt | 123. Thrust washer (thick) |
| 33. Adjuster | 75. Forward shaft | 124. Third gear brake band |
| 34. Cam assembly | 76. Circlip | 125. Bevel gear train |
| 35. Plain bush | 77. End plate | 126. Sealing ring |
| 36. Speedometer pinion housing | 78. Intermediate plate | 127. End plate spacer |
| 37. Speedometer pinion | 79. Clutch plates | 128. Freewheel |
| 38. Speedometer drive housing | 80. Reverse shut off valve | 129. Intermediate spacer |
| 39. Speedometer gear | 81. Pressure plate | 130. Needle - roller bearing |
| 40. End housing | 82. Toggle | 131. Freewheel housing |
| 41. Thrust washer | 83. Piston | 132. Main oil strainer |
| 42. Governor drive gears | 84. Reverse shut - off valve piston | 133. Oil pick - up pipe |
| | 85. Forward clutch | 134. Needle - roller bearing |
| | 86. Forward clutch shaft rings | 135. Reverse gear brake band |
| | 87. Assembly sleeve | 136. Freewheel reaction member |
| | 88. Kick - down linkage | |
| | 89. Nut | |
| | 90. Lock washer | |
| | 91. Forward clutch hub | |

AUTOMATIC GEARBOX

DESCRIPTION

The automatic gearbox incorporates a three - element fluid torque converter coupled with a bevel gear train which provides four forward gears and reverse. The system is controlled by a floor - mounted selector lever within a gated quadrant marked with six positions:

Selector positions

'R' for reverse

'N' for neutral

'1' for first gear

'2' for second gear

'3' for third gear

'D' for automatic drive using all forward gears.

The system can be used as a fully automatic four - speed gearbox, with the gears changing automatically from rest to maximum speed according to the throttle position and load. If a lower gear is required to obtain greater acceleration, an instant full throttle position, i.e 'kick - down' on the accelerator, immediately produces the down change.

Complete manual control or over - ride is possible in the '1', '2' and '3' positions. However, it is very important that downward changes are effected within the speed range of the gear selected otherwise serious damage may result to the automatic gearbox components. The second '2', third '3' and top gears, provide engine braking whether driving 'manual' or 'automatic'. Manual selection allows the driver to stay in a particular gear to suit conditions.

Note: There is NO engine braking in first gear '1' , it is a 'FREE WHEEL' gear on over - run.

Recommended speed ranges

	m.p.h.	km/h
First '1'	0 to 25	0 to 40
Second '2'	5 to 45	8 to 72
Third '3'	15 to 55	25 to 88

MECHANICAL SYSTEM

- refer to diagrams on pages 6 to 11.

Torque converter

The hydraulic torque converter has a maximum torque conversion ratio of 2 : 1 and provides a means of obtaining additional engine torque when starting from rest and accelerating in first, second and third ratios.

Clutches

The hydraulically operated multi - disc clutches connect the gear train to the final drive. In forward ratios the forward clutch is applied; in reverse gear the top and reverse clutch is applied. The top and reverse clutch has a tandem piston arrangement; when a reverse gear is engaged both pistons are pressurised and provide a greater clamping load to the clutch plates.

Bands and servos

Three servo - operated bands are used; second gear band is applied for second gear, the third gear band for third gear, the reverse gear band for reverse. The bands apply a clamping load on members of the gear train and hold them stationary to provide the gear ratios.

One - way clutch

The one - way clutch is used in the first ratio of drive. The forward clutch is applied, the carrier is stationary, its reaction being controlled by the one - way clutch.

Gear train

The gear train is of the epicyclic type and has eight spiral bevel gears. Engine power is transmitted from the converter output gear through an idler gear to the input gear which drives the bevel reduction gears in the gear train assembly.

Governor

The governor is sensitive to both road speed and throttle position, and controls the upward and downward gear - changes while 'D' is selected.

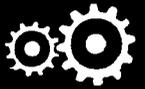

HYDRAULIC SYSTEM

- refer to diagrams on pages 12 to 14.

The automatic gearbox is controlled hydraulically by the valve block assembly under the combined influence of the driver, using the selector lever and throttle pedal, together with a governor, sensitive to throttle pedal operation and road speed.

Oil Pump

The engine oil pump has a high potential output and serves both the engine lubrication and automatic gearbox from a common oil supply.

Valve block

The valve block consists of three basic units, i.e the lid, valve chest, and pipe chest. The valve chest incorporates the various valves, details of which are given below.

The selector valve directs oil from the main supply to either the governor valve for automatic gear - shifting, or to the appropriate clutch or servo for manual selection.

The regulator valve controls the main line pressure, a secondary piston on the valve boosts this pressure when reverse is selected.

The governor valve movement is controlled by the mechanical governor and it directs the oil flow to the appropriate clutch or servo for automatic gear - shifts.

The relay valves are used for shifts from second to third and third to top. They enable the clutch or servo required to be supplied either from the selector valve in 'manual' control or the governor valve in 'automatic'. In addition, pistons are fitted in front of the second and third relay valves to ensure that on up - shifts the engagement of the new ratio and release of the old occur simultaneously to prevent engine overspeeding between shifts. A relay valve is not required for the first gear as the torque reaction is controlled mechanically by a one - way clutch.

The engagement control valve has a primary function of eliminating harsh engagement when selecting 'D' or a forward gear from the rest position.

Operation of engagement control valve.

When a forward gear is selected, the selector valve in the valve block directs oil to shuttle valves located in the back of the valve block. The oil passes through the shuttle valves and pressurises the third and reverse gear servos, thus applying the brake bands and bringing the rotating components of the gear train gently to rest. The oil flows simultaneously to the engagement control valve which, at a predetermined pressure, directs oil to the forward clutch; and as there is relatively little movement between the driving and driven members the gear engagement is smooth.

To complete the operating sequence, oil is also fed behind the shuttle valves which move and allow the oil pressure in the third and reverse servos to exhaust, thus releasing the third and reverse gear bands.

Converter

The three - element type converter is bolted to the tapered end of the crankshaft. Oil under pressure is directed into the converter; surplus oil from the converter passes through a low pressure valve, eventually into the gear train for lubrication and return to sump. A

Torque multiplication is at maximum at turbine stall and slightly above 2:1 varying infinitely as turbine speed increases to a 1:1 ratio when the stator rotates at the same speed as the impeller and turbine.

Low pressure valve

This valve controls the pressure in the converter to 30 lbf/in², 2.1 bar. When the engine is stopped the valve is seated, preventing the converter draining. This ensures that the oil level is stable when checking the combined engine/gearbox oil level and also provides an efficient converter when starting the engine.

AUTOMATIC GEARBOX

MECHANICAL POWER FLOW DIAGRAMS

The power flow diagrams indicate how the various ratios are obtained. Four speeds and reverse are provided and these are brought into operation by engaging the appropriate friction members.

NEUTRAL

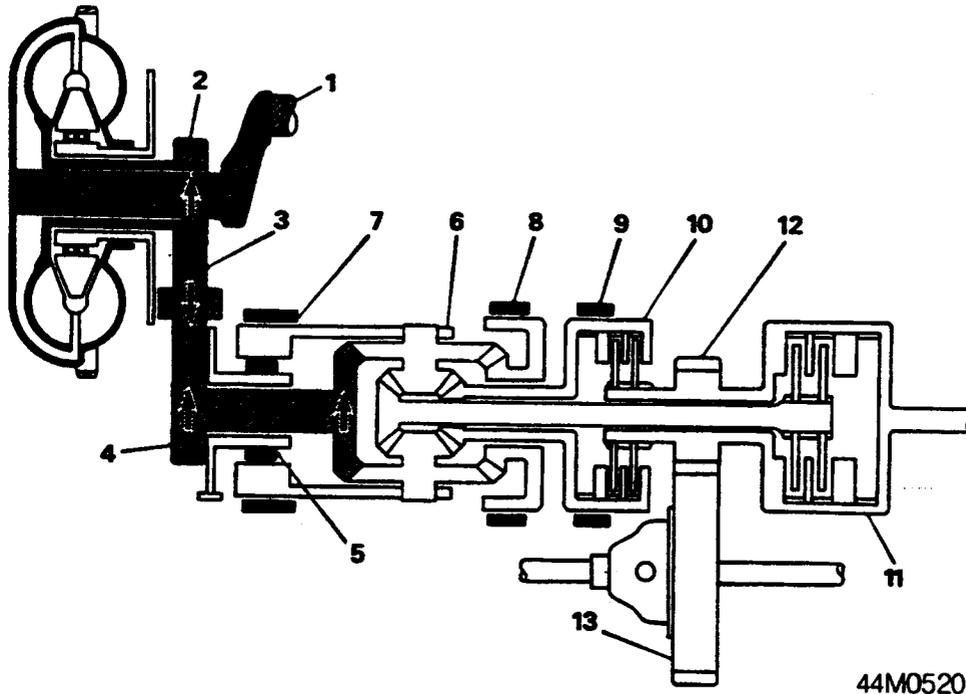

44M0520

NEUTRAL

When in neutral all the bands and clutches are disengaged, therefore there is no drive to the final drive pinion.

KEY-TO COMPONENTS

1. Crankshaft
2. Converter output gear
3. Idler gear
4. Input gear
5. One - way clutch
6. Gear carrier
7. Reverse band
8. Third gear band
9. Second gear band
10. Top and reverse clutch
11. Forward clutch
12. Final drive pinion
13. Final drive gear



FIRST GEAR

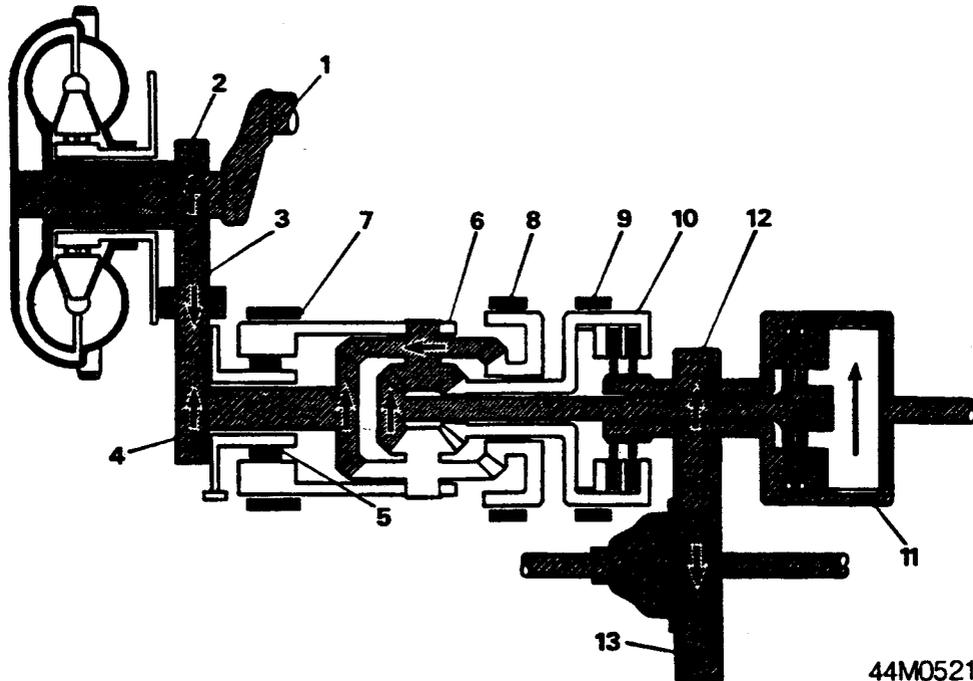

44M0521

FIRST GEAR ('1' or 'D' selected)

Forward clutch applied and the one-way clutch operative. The carrier is stationary, its reaction being controlled by the one-way clutch.

The input bevel gear drives the planet wheels and the planet pinions drive the forward output pinion and shaft. Power is thus transferred through the planet assemblies to the mainshaft, forward clutch and the forward output gear.

Gear ratio 2.69:1.

AUTOMATIC GEARBOX

MECHANICAL POWER FLOW DIAGRAMS

SECOND GEAR

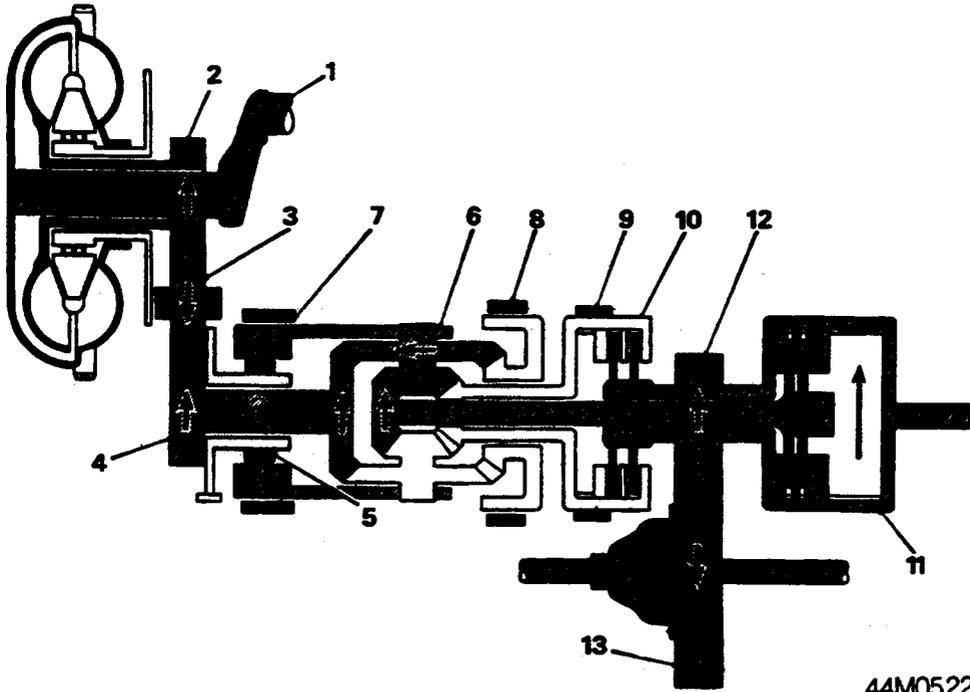

44M0522

SECOND GEAR ('2' or 'D' selected)

Forward clutch applied and second gear reaction band applied to hold the top and reverse clutch drum stationary. With the planet gear cluster orbiting around the reverse output bevel gear, power is transmitted from the input bevel gear through the planets to the mainshaft.

Gear ratio 1.845:1.

KEY TO COMPONENTS

1. Crankshaft
2. Converter output gear
3. Idler gear
4. Input gear
5. One - way clutch
6. Gear carrier
7. Reverse band
8. Third gear band
9. Second gear band
10. Top and reverse clutch
11. Forward clutch
12. Final drive pinion
13. Final drive gear

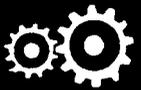

THIRD GEAR

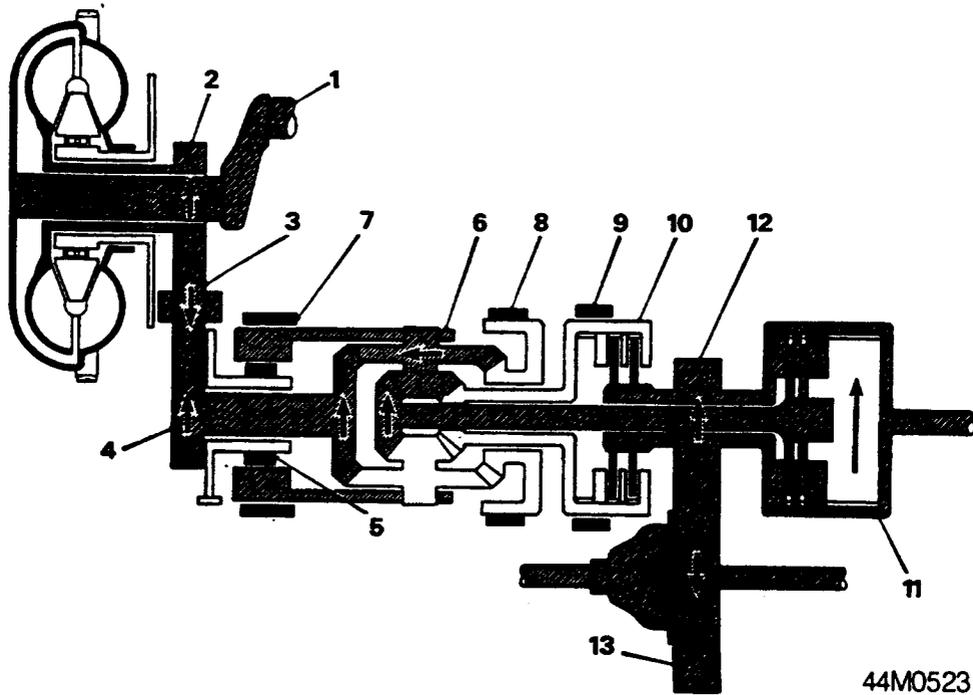

THIRD GEAR ('3' or 'D' selected)

Forward clutch applied and the third gear reaction band applied to hold the third speed reaction gear stationary. The planet gear cluster orbits around this gear and increases the speed of the carrier. Power is transmitted from the input bevel gear through the planets to the mainshaft.
Gear ratio 1.46:1.

AUTOMATIC GEARBOX

MECHANICAL POWER FLOW DIAGRAMS

TOP GEAR

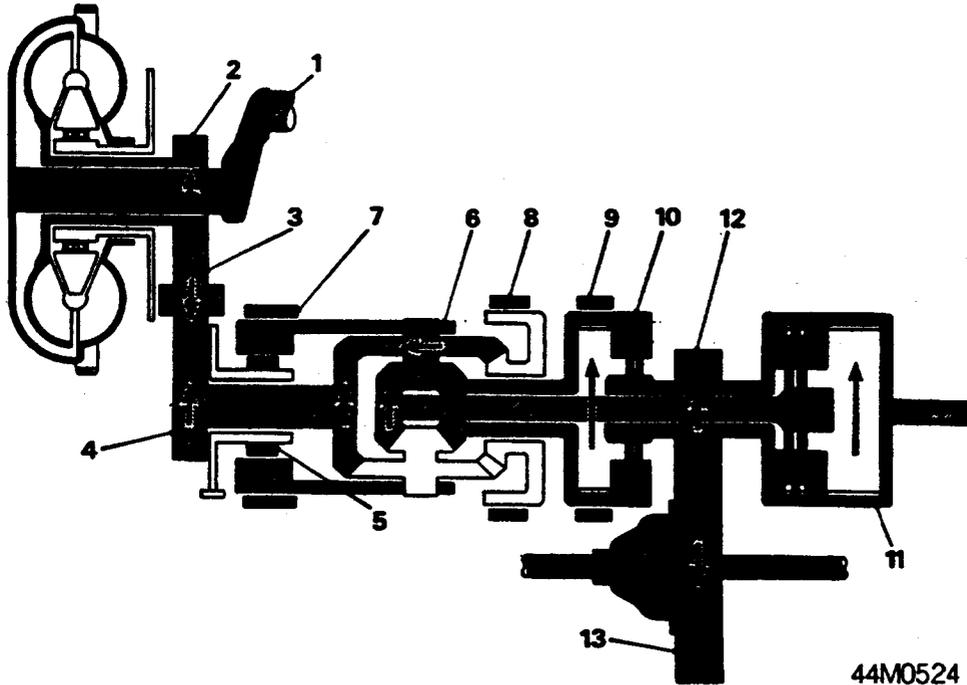

TOP GEAR ('D' selected)

All brake bands are released. Forward clutch applied, top and reverse clutch applied. This in effect holds the bevel and reduction gears stationary within the gear carrier. The complete assembly then rotates as one unit to provide direct drive.

Gear ratio 1.0:1.

KEY TO COMPONENTS

1. Crankshaft
2. Converter output gear
3. Idler gear
4. Input gear
5. One - way clutch
6. Gear carrier
7. Reverse band
8. Third gear band
9. Second gear band
10. Top and reverse clutch
11. Forward clutch
12. Final drive pinion
13. Final drive gear

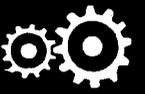

REVERSE GEAR

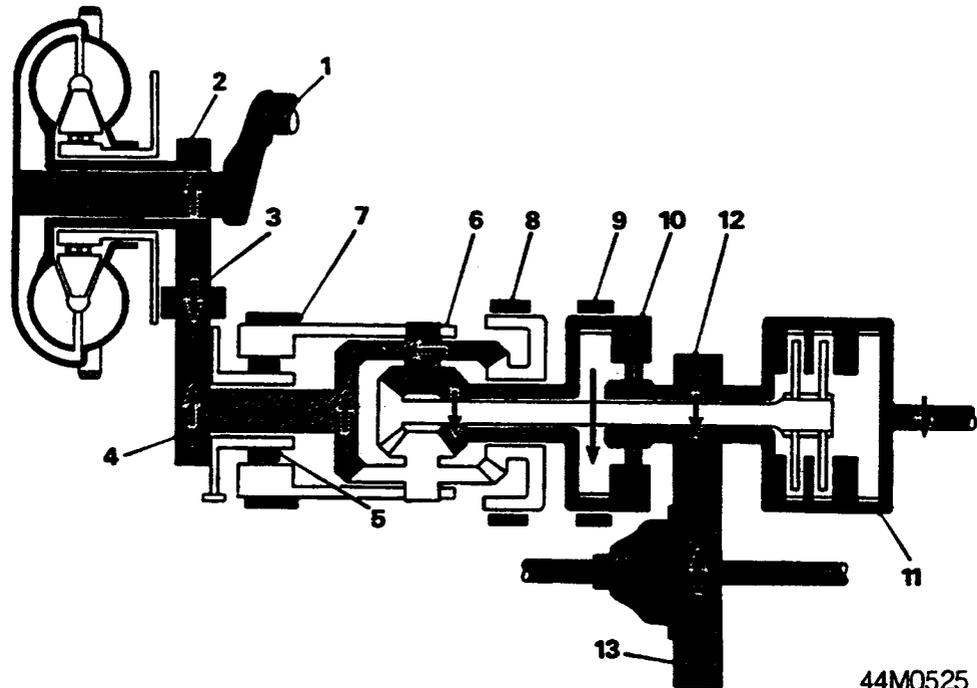

44M0525

REVERSE GEAR ('R' selected)

Top and reverse clutch applied. The reverse brake band is also applied to hold the carrier stationary, the planet gears rotate the third speed reaction gear in the opposite direction to the input gear. Power is transmitting reverse drive through top and reverse clutch to the final drive.
Gear ratio 2.69:1.

AUTOMATIC GEARBOX

LINE PRESSURE AND LUBRICATION DIAGRAMS

NEUTRAL

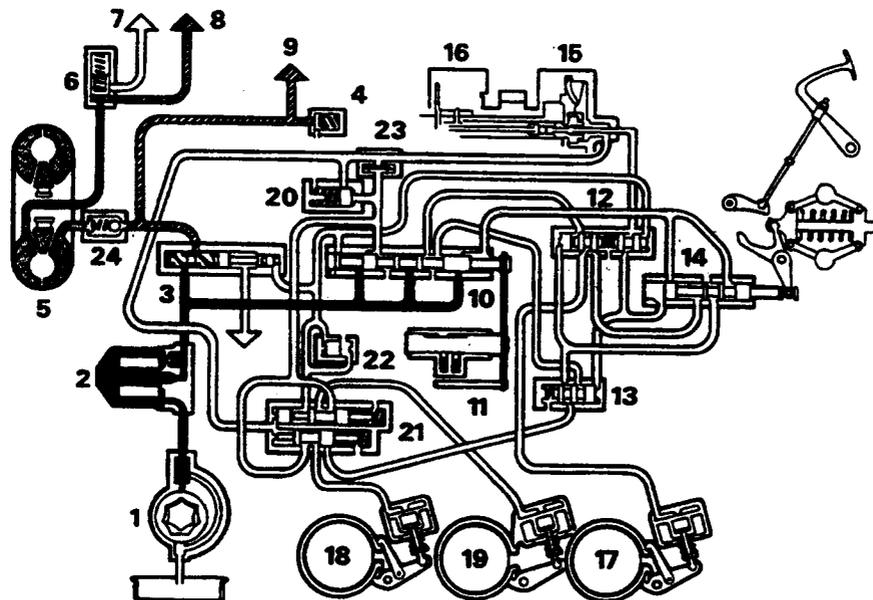

44M0526

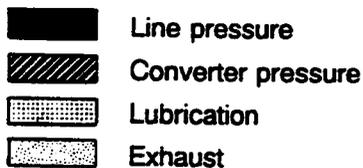

44M0527

KEYS TO DIAGRAMS

1. Main oil pump
2. Oil filter
3. Regulator valve
4. Engine lubricating relief valve
5. Converter
6. Low pressure valve
7. To sump
8. Gear train lubrication
9. Engine lubrication
10. Selector valve
11. Selector valve detent
12. Second and top gear valves
13. Third gear valve
14. Governor valve
15. Forward clutch
16. Top and reverse clutch
17. Second gear brake band
18. Third gear brake band
19. Reverse gear brake band
20. Engagement control pressure valve
21. Engagement control shuttle valves
22. One-way dump valve
23. One-way flap valve
24. Restrictor valve (in converter pipe)

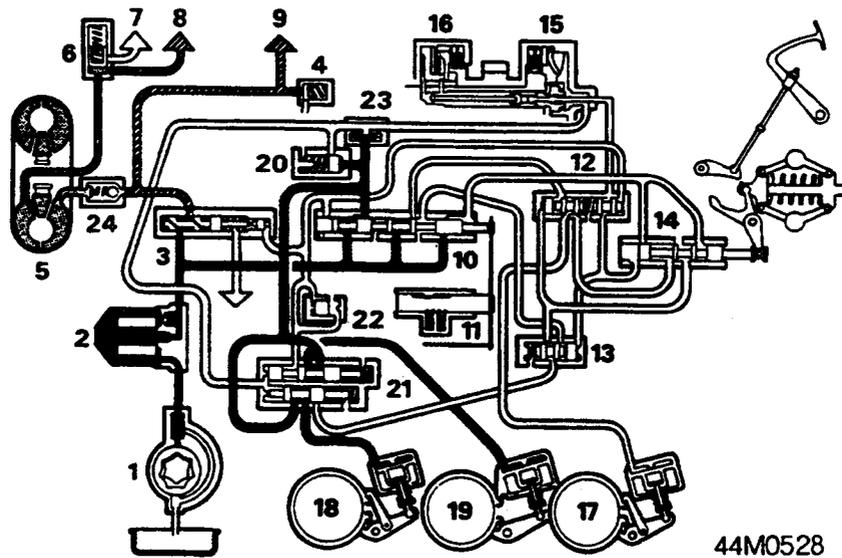
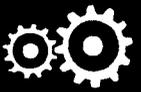

FORWARD CLUTCH ENGAGEMENT

STAGE 1:

The selector valve directs oil through the shuttle valves to pressurise the third and reverse gear servos, and simultaneously to the engagement control valve, which, at a predetermined pressure, directs oil to apply the forward clutch.

KEY TO DIAGRAMS

1. Main oil pump
2. Oil filter
3. Regulator valve
4. Engine lubrication relief valve
5. Converter
6. Low pressure valve
7. To sump
8. Gear train lubrication
9. Engine lubrication
10. Selector valve
11. Selector valve detent
12. Second and top gear valves
13. Third gear valve
14. Governor valve
15. Forward clutch
16. Top and reverse clutch
17. Second gear brake band
18. Third gear brake band
19. Reverse gear brake band
20. Engagement control pressure valve
21. Engagement control shuttle valves
22. One - way dump valve
23. One - way flap valve
24. Restrictor valve (in converter pipe)

AUTOMATIC GEARBOX

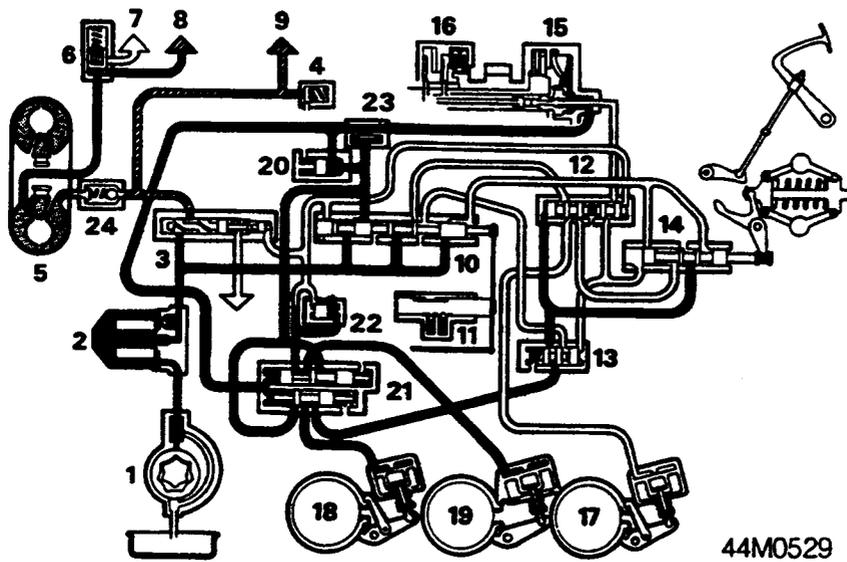

44M0529

FORWARD CLUTCH ENGAGEMENT STAGE II:

With the forward clutch applied, the shuttle valves move and allow the oil pressure in the third and reverse servos to exhaust and thus release the third and reverse gear bands.

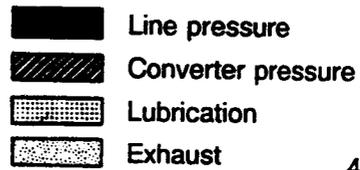

44M0527

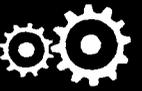

SERVICE REQUIREMENTS

1. Fully road test and diagnose faults as detailed in the Mechanical Fault Finding Manual before dismantling an automatic gearbox. Use ROAD TEST PROCEDURE and DIAGNOSIS CHART; make adjustments as necessary and re - test after rectification.
2. High standards of cleanliness are essential: Clean outside of casing with paraffin prior to removal of any components. Rags and cloth must be clean and lint free, preferably nylon.
3. Prior to assembly, clean all parts in chlorinated industrial solvent only. Renew all defective components. Lubricate all components with engine oil. **DO NOT assemble dry .**
4. Use new joint washers. Where jointing compound is required use Hylomar SQ32M, Hermetite or Wellseal, or an equivalent.
5. Retain thrust washers and bearings with petroleum jelly; do not use grease.
6. Tighten screws, bolts and nuts to recommended torque figure.
7. For all operations where access is required beneath vehicle, it should be on a lift, over a pit or front raised on stands.
8. **Use only ROVER genuine parts.**

AUTOMATIC GEARBOX

EXAMINATION OF COMPONENTS

Service Repair No. 44.01.02

Transmission case and servo castings	Check for cracks and obstruction in passages
Oil pump	Check for scoring and excessive wear
Shafts	Check bearing and thrust faces for scoring
Clutch plates	Check for warping, scoring, overheating and excessive wear
Bands	Check for scoring, overheating and excessive wear
Drums	Check for overheating and scoring
Gears	Check teeth for chipping, scoring, wear and condition of thrust faces
Uni-directional clutch and races	Check for scoring, overheating and wear
Valve block and governor	Check for burrs, crossed or stripped threads, and scored sealing faces
Impeller hub	Check for pitting and wear. Ensure good contact
Thrust washers	Check for burrs, scoring and wear
White metal bushes	Check for scoring and loss of white metal
Lip seals	Check for cuts, hardening of rubber, leakage past outer diameter
Rubber 'O' rings and seals	Check for hardening, cracking, cuts or damage
Sealing rings	Check fit in groove and wear (evident by lip overhanging groove)

TEST EQUIPMENT

Service Repair No. 44.01.03

Connecting

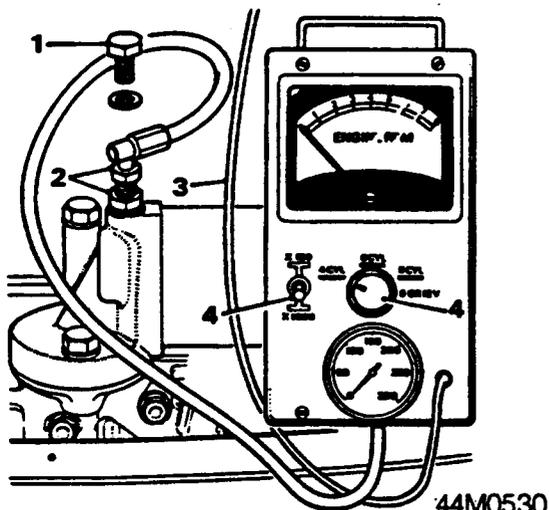

1. Remove screwed plug from oil filter head
2. Fit tool adapter 18G 677C into filter head and connect the pressure pipe union of tool 18G 677Z onto adapter.
3. Connect tachometer connections of tool 18G 677Z as follows:
 - a Red connection to ignition coil (+)
 - b Black connection to battery earth (-).
4. Set tool 18G 677Z to '4' CYL and 'x1000'.



ROAD TEST PROCEDURE

Service Repair No. 44.01.04

Connect test equipment **18G 677Z** to engine and transmission, see **Test equipment**, and position equipment inside car where it can be read from driver's seat.

Carry out this test procedure completely, in order given noting:

Tests 1 to 4 Rectify any fault as it is found before proceeding to the next test.

Tests 5 to 11. It may be possible to complete these tests, noting any faults in order to rectify them after tests. However, it must be noted that this could allow one fault to mask another.

Test	Fault	Rectification
1. Check oil level	a Oil level incorrect	1a Correct oil level, see MAINTENANCE .
2. Check throttle with pedal fully depressed	a Throttle not fully open	2a Adjust throttle cable
3. Check adjustment of selector cable	a Cable is out of adjustment	3a Adjust cable 3b Check inhibitor switch and its wiring for short - circuiting
4. Check that starter will operate only when 'N' is selected	a Starter will not operate in 'N' and 'P' b Starter operates in all positions	4a Adjust inhibitor switch
5. If possible, run engine until it reaches its normal operating temperature. Chock wheels, apply brakes and run engine at 1000 rev/min for 'D' and 1200 rev/min for 'R' Select each transmission position in turn and note pressure registered.	a In position 'N', '1', '2', '3', 'D': Less than 6.5 bar, 95 lbf/in ² b In position 'R': Less than 11.3 bar, 165 lbf/in ²	5a Refer to Pressure test diagnosis* 5b Refer to Pressure test diagnosis*
6. Apply hand and foot brakes, and with engine idling, select 'R' from 'N' and '1' from 'N'	a Excessive bump on engagement of 'R' or '1' b Engine stalls on engagement of 'R' or '1'	6a Reduce engine idle speed to within specified limits 6b Increase engine idle speed to within specified limits
7. Select '1', release brakes and check that car drives forward but that there is no engine braking when throttle is released	a Car does not drive forward b Engine braking can be felt	7a Remove and check forward clutch and one - way clutch fixing bolt; if satisfactory renew freewheel 7b Renew free wheel
8. Select '1' and drive away, using manual gear - change to select '2' and '3' progressively as road speed increases. When road speed is above 25 m.p.h. (40 km.h) select 'D' and release throttle pedal	a Drive in '1' but not in '2' b Drive in '1' and '2', but not in '3'. c Drive in '1', '2', and '3', but no upward gear - change (to fourth gear) on selecting 'D'	8a Check second gear brake band adjustment. If satisfactory, check second gear servo. 8b Check third gear brake band adjustment. If satisfactory, check third gear servo. 8c Check kick - down linkage adjustment. If correct, check the governor for freedom of operation. If governor is satisfactory, remove and check top reverse clutch

AUTOMATIC GEARBOX

Test	Fault	Rectification
<p>9. Stop car, select 'D' and accelerate up through the gears using 'kick - down'. Check that gear - changes occur within speed range, see SHIFT SPEEDS</p>	<p>a Gear - changes occur at low speeds b Gear - changes occur at high speed</p>	<p>9a Check kick - down linkage adjustment 9b Check kick - down linkage adjustment. If correct, check the governor for freedom of operation</p>
<p>10. Stop car, select 'R' and drive car backwards</p>	<p>a Car will not drive backwards</p>	<p>10a Check reverse gear brake band adjustment. If satisfactory, check reverse servo.</p>
<p>11. Stall test: Ensure engine is at normal running temperature. Chock front wheels and apply hand and foot brakes. Select 'D', pause for 5 seconds and then gradually fully depress throttle pedal for not more than 5 seconds . Note highest rev/min obtained. Allow gearbox to cool for one minute. Select 'R', repeat above test and note highest rev/min obtained.</p>	<p>a A reading outside range 1500 to 1800 rev/min</p> <p>Conduct stall test in open area with space in front of and behind vehicle.</p> <p>Ensure selector cable is set correctly.</p>	<p>11a Refer to Stall test diagnosis*</p>

*Refer to **Mechanical Fault Finding Manual**



SHIFT SPEEDS

Service Repair No. 44.01.07

Following chart indicates speed range at which automatic gear changes should take place when driving with 'D' selected and the throttle in various positions.

Shift speed chart

Shift	Light throttle	Full throttle	Kick - down shift	Kick - down
MPH 1 - 2	11 - 16	25 - 33	4 - 3	48 - 58
2 - 3	15 - 20	25 - 33	3 - 2	34 - 29
3 - 4	22 - 28	55 - 65	2 - 1	22 - 29
km/h 1 - 2	18 - 25	40 - 53	4 - 3	77 - 93
2 - 3	24 - 32	61 - 74	3 - 2	55 - 70
3 - 4	35 - 45	88 - 105	2 - 1	35 - 46

SELECTOR CABLE ADJUSTMENT

Checking

1. Apply handbrake, position selector lever at 'P' and start engine.
2. Move selector lever into 'R' and note that reverse engages.

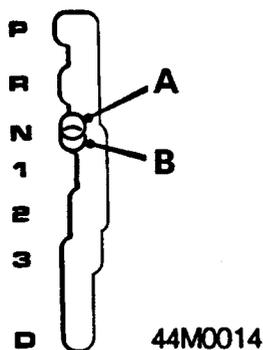

3. Slowly move selector lever to 'N', reverse must disengage at position A in illustration.
4. Move selector lever into '1' and note that first gear engages.
5. Slowly move selector lever back to 'N', first gear must have disengaged when position B in illustration is reached.
6. If above conditions have not been met, selector cable must be adjusted.
7. Stop engine, select 'P'.

Adjusting

1. Raise front of vehicle.

WARNING: Support on safety stands.

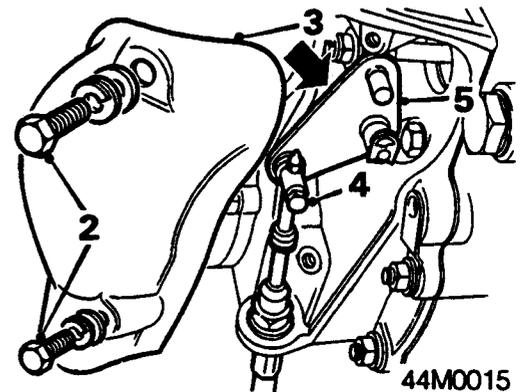

2. Remove 2 bolts, gear selector cable cover to gearbox.
3. Remove cover.
4. Slacken screw clamping gear selector cable.
5. Rotate bellcrank lever anti-clockwise to position valve rod in its fully out (park) position.

AUTOMATIC GEARBOX

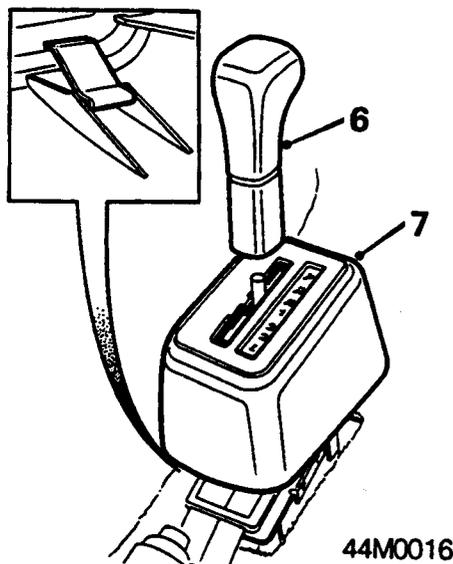

6. Unscrew knob from gear selector lever.
7. Lift off selector lever housing, noting 4 retaining clips which may become detached.

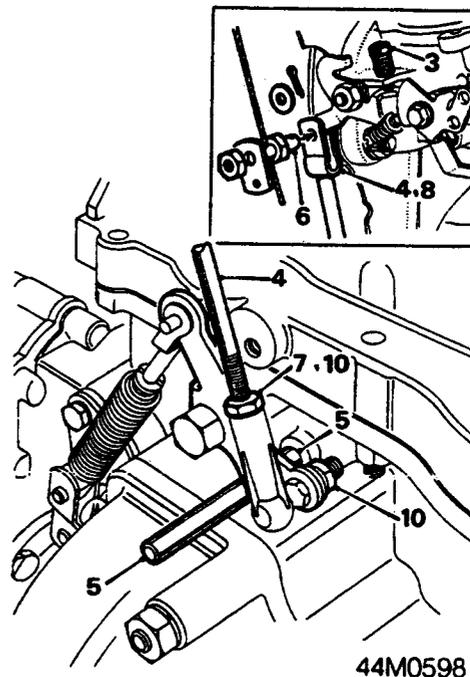

3. Check engine idling speed with tachometer, adjust idle speed if necessary.
4. Disconnect kick - down control rod at throttle lever.
5. Insert a 6.0mm diameter rod through hole in intermediate bell - crank lever and locate in hole in the gearbox casing.
6. Check if kick - down control rod can now be re - connected to throttle linkage, with its fulcrum pin an easy sliding fit through its forked end and throttle lever.

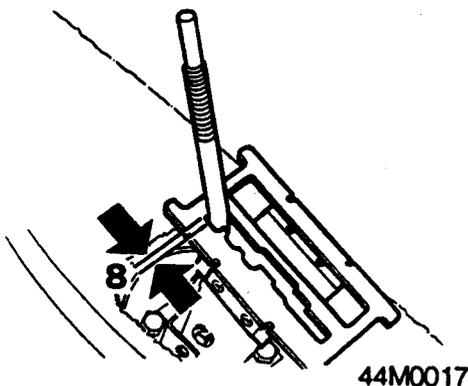

8. Insert a feeler gauge of 0.76 to 0.89 mm between selector lever and end of slot in selector gate.
9. Keeping selector lever against feeler gauge, tighten cable clamp to 4 Nm.
10. Fit selector cable cover, fit and tighten cover bolts.
11. Fit 4 retaining clips to slots inside selector lever housing and fit housing.
12. Fit selector lever knob.
13. Remove stand(s) and lower vehicle.
14. Carry out checking procedure to ensure adjustment is correct.

Adjust

7. Slacken kick - down rod ball - joint locking nut.
8. Disconnect forked end of rod at throttle lever and turn rod until correct length is obtained.
9. Re - connect rod at throttle lever, tighten ball - joint locking nut and remove checking rod.
10. Test drive car to ensure that 'kick - down' changes occur within speed range given in Test 9 of **TEST PROCEDURE**
 - a. If gear changes occur at a lower speed, slacken ball joint locking nut, disconnect ball - joint and screw it onto rod a further two complete turns. Reconnect and tighten ball - joint and re - check kick - down changes.
 - b. If gear changes occur at a higher speed, follow procedure in 'a' except that ball - joint must be unscrewed two complete turns to lengthen rod.

KICK - DOWN LINKAGE ADJUST

Service Repair No. 44.30.02

Check

1. Connect tachometer connections of 18G 677ZC, see **Service Requirements**.
2. Run engine to its normal running temperature.

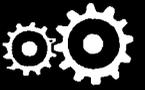

STARTER INHIBITOR SWITCH ADJUSTMENT

1. Ensure gear selector cable is correctly adjusted.
2. Raise front of vehicle.

WARNING: Support on safety stands.

3. Position gear selector lever at 'D'.

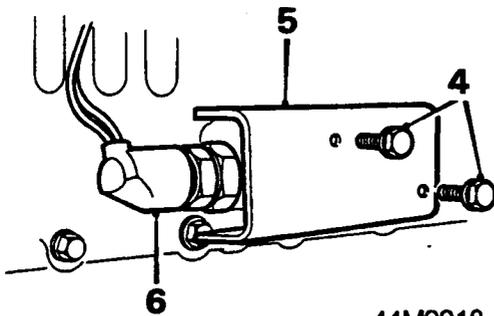

44M0018

4. Remove 2 bolts, inhibitor switch cover to gearbox.
5. Remove inhibitor switch cover.
6. Disconnect inhibitor switch plug.

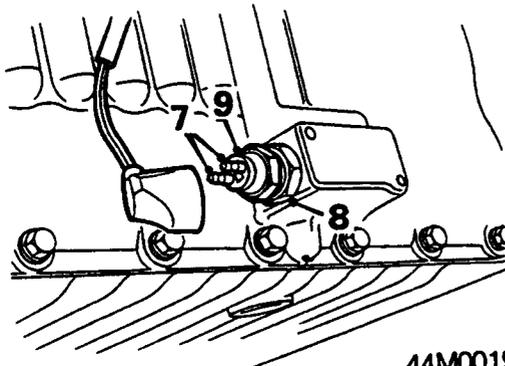

44M0019

7. Connect a circuit continuity tester across switch terminals.
8. Slacken switch locknut.
9. Unscrew switch until circuit is made.
10. Screw switch in until circuit is just broken, then screw switch in a further 3 to 4 flats.
11. Hold switch in this position and tighten locknut to 5 Nm.
12. Check to ensure that circuit is made only when selector lever is at 'P' and 'N'.
13. Remove continuity tester and connect switch plug.
14. Fit selector cable cover, fit and tighten cover bolts.
15. Position gear selector at 'P'.
16. Remove stand(s) and lower vehicle.
17. Check that engine will start only when selector lever is at 'P' and 'N'.

REVERSE LIGHT SWITCH ADJUSTMENT

1. Raise front of vehicle.

WARNING: Support on safety stands.

2. Position gear selector lever at 'R'.

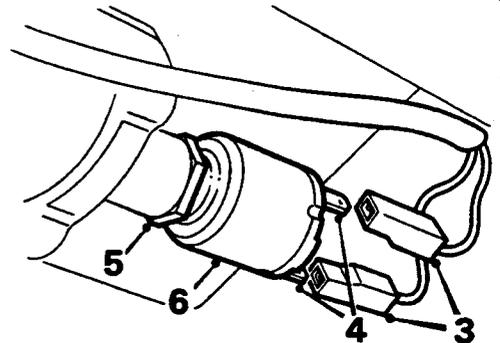

44M0020

3. Disconnect 2 Lucars from reverse light switch.
4. Connect a circuit continuity tester across switch terminals.
5. Slacken reverse light switch locknut.
6. Unscrew switch until circuit is broken.
7. Screw switch in until circuit is just made, then screw switch in a further quarter to half turn.
8. Hold switch in this position and tighten locknut to 5 Nm.
9. Check to ensure circuit is made only when selector lever is at 'R'.
10. Remove continuity tester and connect switch Lucars.
11. Position gear selector lever at 'P'.
12. Remove stand(s) and lower vehicle.

AUTOMATIC GEARBOX

BRAKE BANDS ADJUSTMENT

Service Repair No. 44.30.06

Check

1. Remove front grille.
2. Drain engine/automatic gearbox oil, see **MAINTENANCE**.
3. Raise front of vehicle.

WARNING: Support on safety stands.

4. Remove front cover securing bolts and lift off cover complete with oil filter assembly.

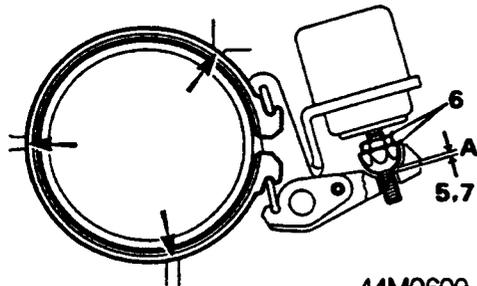

5. Check brake band adjustment; free movement 'A' between servo lever and spherical nut should be 1.02 to 1.03mm.

Adjust

6. Slacken locknut and turn spherical adjusting nut until brake band is in contact with transmission casing stops (arrowed) and all slack is eliminated.
7. Turn spherical adjusting nut downwards into lever just until no free - play exists, then turn adjusting nut upwards 5 to 7 flats.
8. Re - check that clearance is within tolerance figures given; hold spherical nut and tighten locknut.
9. Repeat procedure in 5 to 8 to adjust other two brake bands.
10. Fit a new joint washer coated with Hylomar jointing compound (or equivalent).
11. Refit front cover and tighten retaining bolts.
12. Lower ramp.
13. Refill engine/automatic gearbox with oil, see **MAINTENANCE**.
14. Refit front grille.

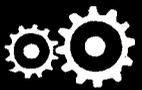

BRAKE BANDS

Service Repair No. 44.10.18

Remove

1. Remove engine/automatic gearbox assembly, see **ENGINE**.
2. Remove gearbox from engine, see **Gearbox assembly**.
3. Remove primary drive gear train assembly, see **Primary drive gears**.

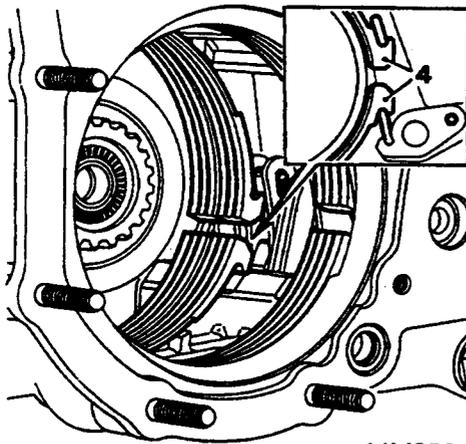

44M0531

4. Unhook three brake bands from servo reaction levers and struts.
5. Manoeuvre each band out through top of gearbox.

WARNING: Use methylated spirit/ denatured alcohol to wash dust from components. Do not use any petroleum - based fluids.

Refit

6. Refit three bands into gearbox and engage them onto servo reaction levers and struts, commencing with second gear band, third gear band and finally 'wider' reverse gear band.
7. Refit primary gear train assembly, see **Primary drive gears**.
8. Remove front cover and check brake band adjustment, see **Adjustments**
9. Refit gearbox to engine. see **Gearbox assembly**.
10. Refit engine/automatic gearbox assembly, see **ENGINE**.

FORWARD CLUTCH

Service Repair No. 44.12.04

Remove

1. Remove engine/automatic gearbox assembly, see **ENGINE**.
2. Remove governor housing assembly, **Governor housing assembly**.

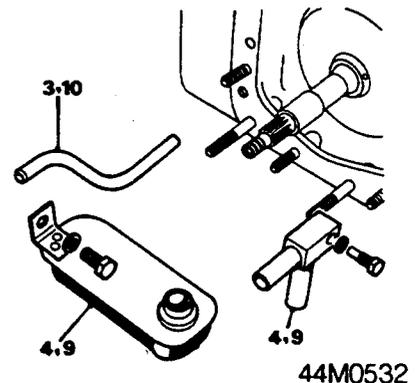

44M0532

3. Remove forward clutch feed pipe.
4. Remove oil strainer and pick - up pipe.

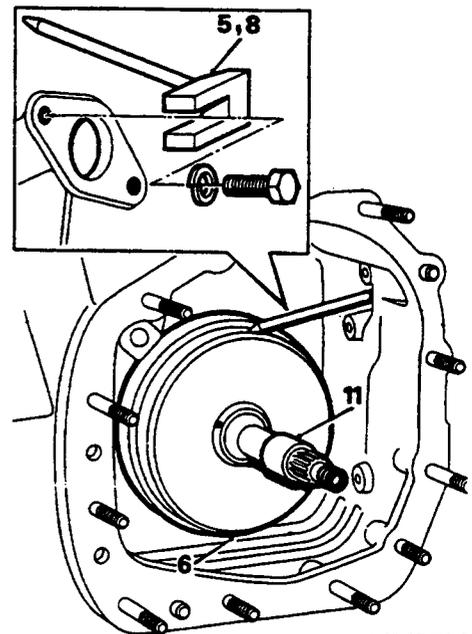

44M0533

5. Remove forward clutch retaining tool 18G 1097.
6. Withdraw forward clutch from gearbox casing.

Refit

7. Refit forward clutch and ensure that clutch plates engage forward clutch hub splines. Rotate clutch assembly backwards and forwards to assist engagement; when correctly fitted, there is only a small clearance between forward clutch and centre web of gearbox casing.

AUTOMATIC GEARBOX

CAUTION: If clutch is not fully engaged on hub splines, flange of governor housing will not contact gearbox casing; any excessive force used may damage clutch plates.

8. Refit 18G 1097 to retain position of forward clutch.
9. Refit and secure oil strainer assembly.
10. Refit forward clutch feed pipe (long end into gearbox casing).
11. Pull nylon assembly sleeve back over rings on forward clutch shaft; it will become safely displaced along shaft when governor housing is refitted.

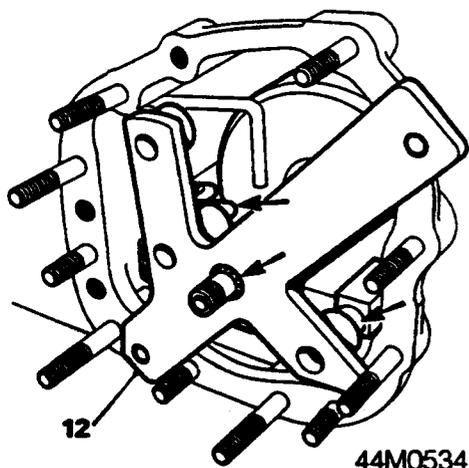

12. Fit 18G 1094 to align forward clutch shaft and oil pipes 'arrowed'; remove tool.
13. Fit a new governor housing joint washer coated with Hylomar jointing compound (or equivalent) onto casing
14. Refit governor housing assembly, **Governor housing assembly.**
15. Refit engine/automatic gearbox assembly, see **ENGINE.**

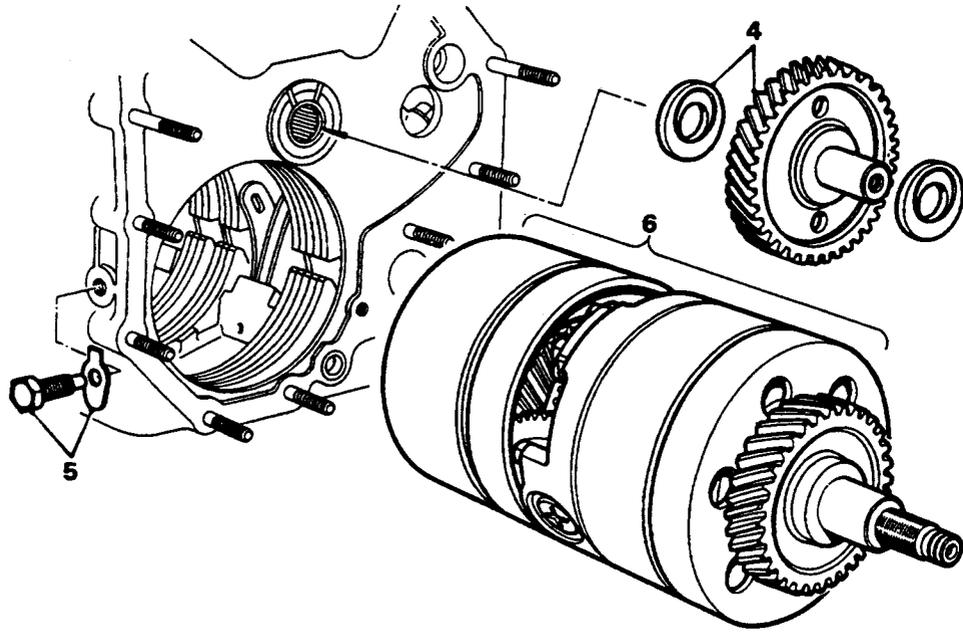
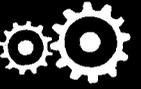

44M0535

TOP AND REVERSE CLUTCH

Service Repair No. 44.12.07

Remove

1. Remove engine/automatic gearbox assembly, see **ENGINE**.
2. Remove converter assembly, see **Converter assembly**.

3. Remove converter housing, see **Converter housing**.
4. Remove idler gear.
5. Knock back lock washer tab and remove dowel bolt securing gear train assembly into gearbox casing.
6. Pull out gear train assembly complete with free - wheel reaction member and top and reverse clutch assembly.

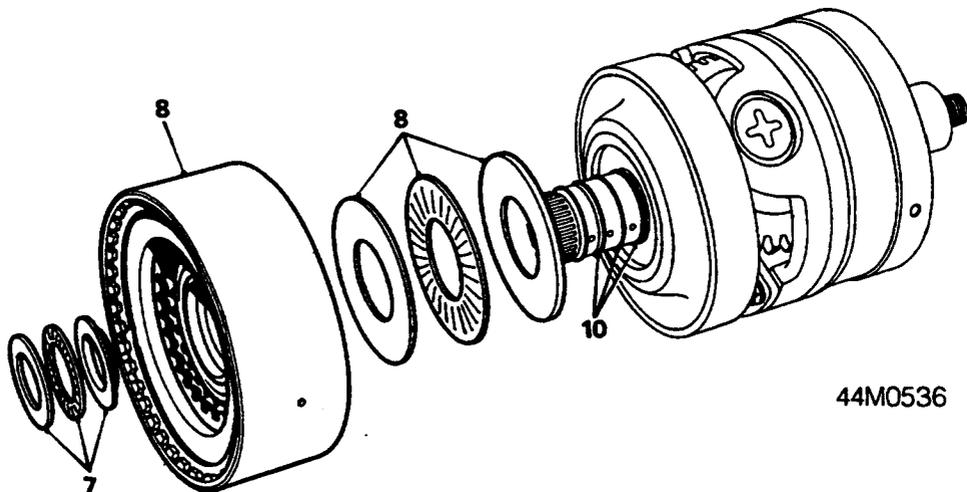

44M0536

7. Remove thrust washer, needle thrust bearing and stepped thrust washer from end of top and reverse clutch.
8. Pull top and reverse clutch off gear train, noting thrust washer (thin), needle thrust bearing, and selective thrust washer (thick), which locate onto reverse output gear shaft.

Refit

9. Ensure that thrust washers and needle thrust bearing referred to in 8 are correctly located.
10. Check that 'O' ring seals located on reverse output gear shaft are in good condition; renew as necessary.

AUTOMATIC GEARBOX

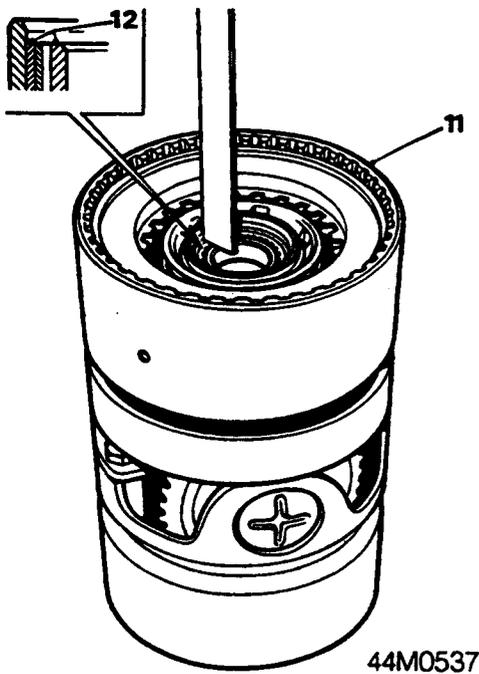

11. Refit top and reverse clutch to gear train assembly.
12. Check across splined end of reverse output shaft and the adjacent face of top and reverse clutch. Both faces must be exactly level with no gap. If both faces are not level with each other, measure difference in height and follow procedure in 13 to 17.
13. Lift off top and reverse clutch.
14. Remove thrust washers and needle thrust bearing.
15. Measure thickness of selective (thick) thrust washer fitted; select required thickness washer from size chart given below.

Note: This adjustment ensures that third speed reaction gear has no end - float and correct backlash is maintained.

Selective washer size chart

Thickness mm	Part Nos
1.93 to 1.98	22G 748
1.83 to 1.88	22G 749
1.73 to 1.78	22G 750
1.63 to 1.68	22G 751

16. Fit selected thrust washer, needle thrust bearing and thin thrust washer.
17. Refit top and reverse clutch and re - check that two faces are now exactly level.
18. Smear petroleum jelly onto stepped thrust washer and locate it on end of top and reverse clutch.
19. Smear petroleum jelly onto thrust washer and needle roller bearing and fit them into their location on top and reverse clutch hub (inside gearbox).

20. Refit gear train complete with free - wheel support and top and reverse clutch into gearbox. Use hand pressure only to push it into position; quick rotation of input gear backwards and forwards will assist in engagement of top and reverse friction plates with top and reverse clutch hub splines.

Note: When correctly assembled dowel bolt will engage easily in free - wheel support.

21. Fit a new lock washer, refit and tighten dowel bolt securing gear train to 38 Nm. Tap over lock washer tab.

CAUTION: Apply a spot Loctite Hydraulic Seal 542 to dowel bolt threads.

22. Refit idler gear.
23. Refit converter housing, see **Converter housing**.
24. Refit converter assembly, see **Converter assembly**.
25. Refit engine/automatic gearbox assembly, see **ENGINE**.

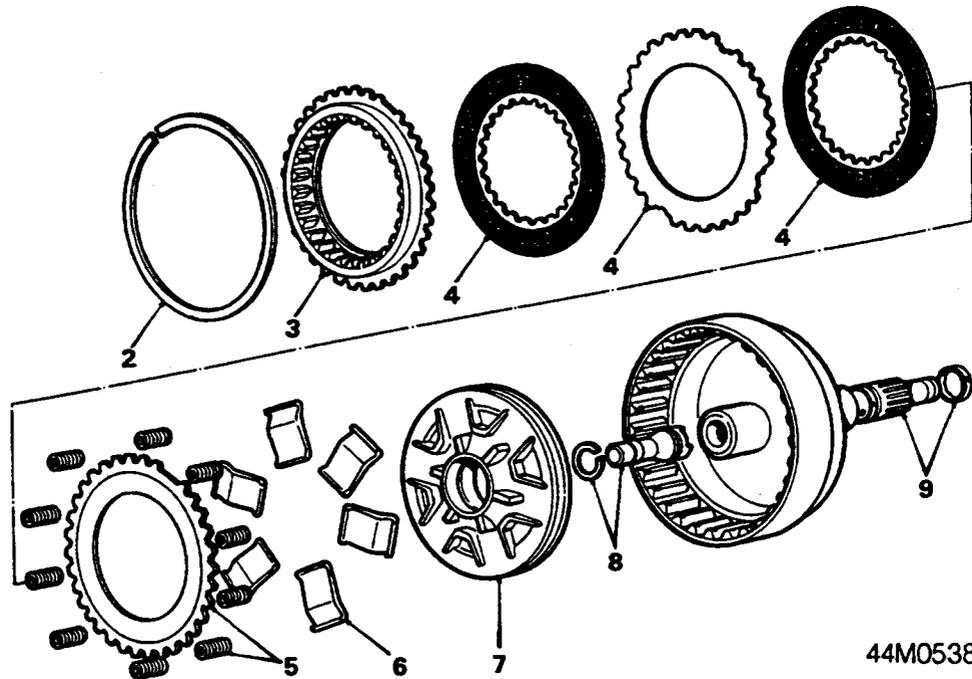
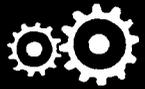

44M0538

FORWARD CLUTCH - OVERHAUL

Service Repair No. 44.12.10

Dismantle

1. Remove forward clutch, see Forward clutch.
2. Remove end - plate circlip.
3. Remove end - plate.
4. Remove clutch plates (two paper - faced interposed with one steel intermediate plate).

WARNING: Use methylated spirit/denatured alcohol to wash dust from components. Do not use any petroleum - based fluids.

5. Lift out piston return springs and pressure plate.
6. Remove six toggles.
7. Use an air pressure line and blow out piston.
8. Extract circlip retaining reverse shut - off valve and withdraw valve.
9. Remove cast - iron sealing rings if replacements are to be fitted.

Inspection

10. Check all parts for wear, and renew as required. Fit new 'O' rings and seals to piston and reverse shut - off valve piston.
11. Check cast - iron sealing rings for wear; rings should not have any sideways movement in their locating grooves; renew as required.
12. Examine all clutch plates and renew those showing signs of wear or damage.

Reassemble

13. Refit reverse shut - off valve piston and secure with a new circlip.

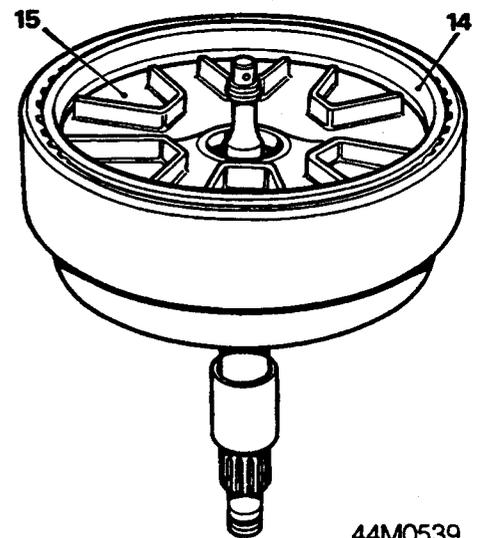

44M0539

14. Fit 18G 1102 into forward clutch drum.
15. Lubricate piston seal with oil, insert piston into tool (lips of seal facing outwards), press piston fully into its bore and remove tool.

AUTOMATIC GEARBOX

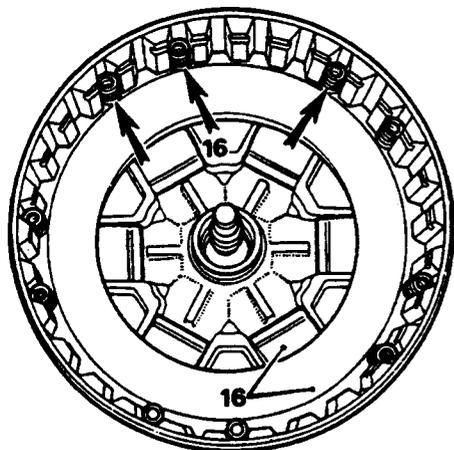

44M0540

16. Refit toggles, pressure plate and piston return springs. Locate spring in order illustrated.

Adjust

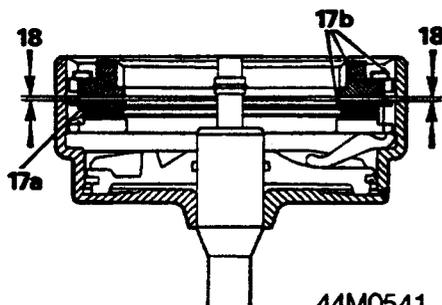

44M0541

17. End - float adjustment. Assemble remaining components in following order for purpose of checking adjustment.
 - a Refit two paper - faced plates together.
 - b Refit intermediate plate, end plate and circlip.
18. Check with feeler gauges clearance between intermediate plate and end plate.

Clearance between intermediate plate and end plate . . . 0.25 to 0.90mm

19. Remove and measure thickness of intermediate and end plates, and from this measurement select from chart given below correct thickness plate(s) to rectify end - float to within tolerance given.

Intermediate and end plate chart

Plate	Thickness	Part No.
Intermediate	1.70mm	27H 7722
Intermediate	1.88mm	37H 7033
End	8.22mm	27H 7724
End	9.21mm	37H 7032

Reassemble

20. Reassemble clutch plates in correct order (see item 4), refit end - plate and circlip.
21. Check that paper - faced plates will move freely, align the plates with each other to assist when refitting unit.
22. Refit forward clutch, see **Forward clutch**.

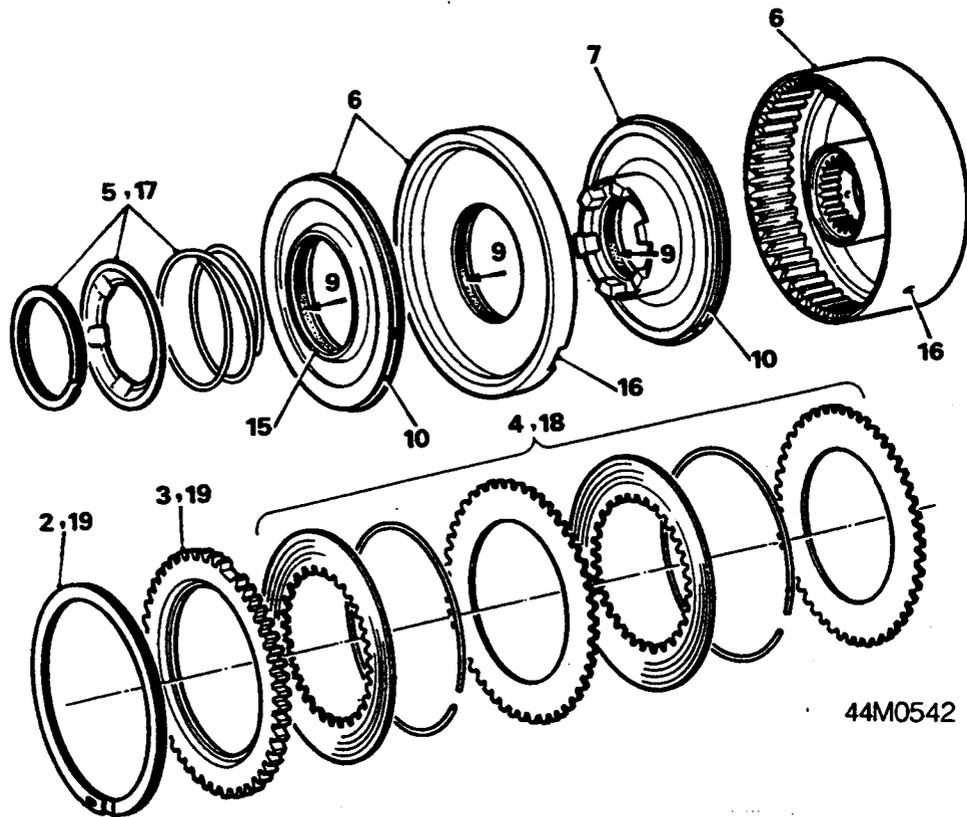

44M0542

TOP AND REVERSE CLUTCH - OVERHAUL

Service Repair No. 44.12.13

Dismantle

1. Remove top and reverse clutch, see Top and reverse clutch.
2. Remove Spirolox circlip.
3. Remove retainer plate.
4. Lift out clutch plates and separation spring rings.

WARNING: Use methylated spirit or denatured alcohol to wash dust from components. Do not use any petroleum - based fluids.

5. Remove Spirolox circlip, spring retainer and piston return coil spring.
6. Lightly shock clutch drum against a flat surface to remove top gear piston and cylinder as one unit.
7. If reverse booster piston has also been shocked out of its bore in clutch drum, refit it, easing piston ring in with a screwdriver.

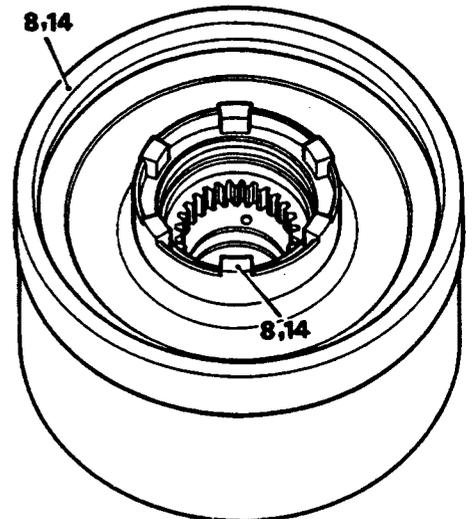

44M0543

8. Fit 18G 1103 into clutch unit, hold both together upside - down and shock assembly against a flat surface to remove reverse booster piston from clutch drum into tool. Lift out 18G 1103 complete with piston and remove piston from tool.
9. Remove seals 'arrowed' from top gear piston, cylinder, and reverse gear booster piston.
10. Remove, if necessary, piston rings from top gear piston and reverse gear booster piston.

AUTOMATIC GEARBOX

Inspect

11. Examine all parts for wear and renew those showing signs of wear or damage. Renew all oil seals in piston and cylinder.
12. Check piston rings, and replace if necessary. Piston ring gap for both rings when fitted in their respective bores is 0.4 to 0.5mm.

Reassemble

13. Lubricate new seals with oil and fit them to their respective components.
14. Insert **18G 1103** into clutch unit, refit reverse gear booster piston (boss facing outwards) into tool, push it squarely downwards into its bore and remove tool.
15. Refit top gear piston into its cylinder, with boss facing outwards.
16. Refit top gear piston and cylinder assembly into clutch, with cut - aways on rear outer edge of cylinder opposite holes in clutch drum.
17. Refit top gear piston return spring, spring retainer and Spirolox circlip.
18. Refit clutch plates and separator spring rings in order illustrated, with cut - away portion of steel plates in alignment.
19. Refit retainer plate and Spirolox circlip.

Note: Before refitting clutch unit ensure that bronze plates can be moved freely into alignment with each other.

20. Refit top and reverse clutch, see **Top and reverse clutch**.

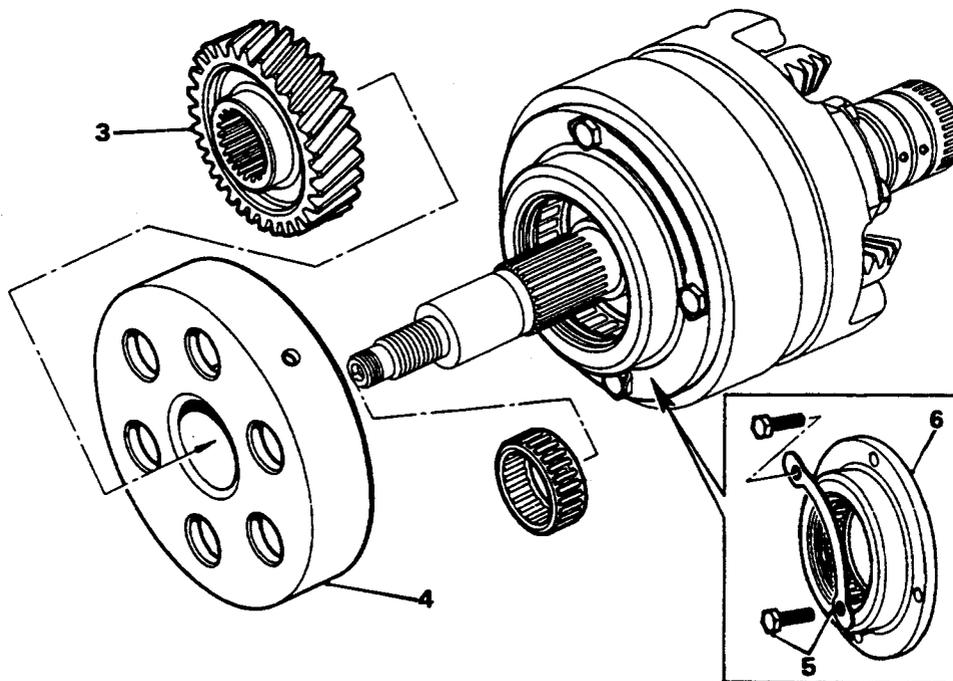
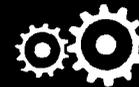

44M0545

FIRST GEAR FREE - WHEEL ASSEMBLY

Service Repair No. 44.12.16

Remove

1. Remove engine/automatic gearbox assembly, see **ENGINE**.
2. Remove gear train assembly, see **Primary drive gears**.
3. Pull off input gear.
4. Remove first gear free - wheel reaction member.
5. Knock back locking plate tabs and remove bolts retaining first gear free - wheel assembly to gear train.
6. Lift off first gear free - wheel housing assembly.

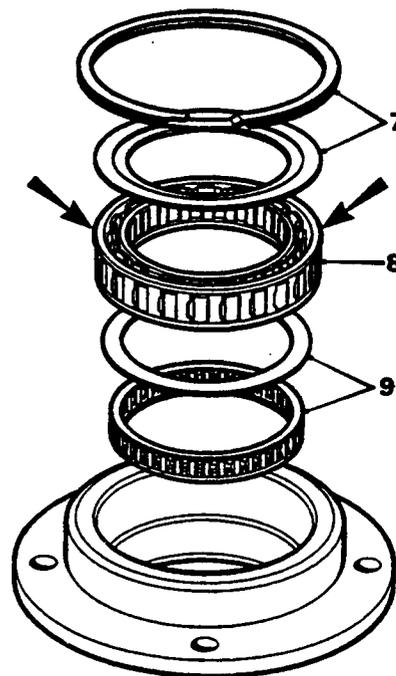

44M0544

7. Remove Spirolox circlip and end plate spacer.
8. Lift out first gear free - wheel.
9. Remove intermediate spacer plate and needle thrust bearing.

Inspection

10. Examine free - wheel unit and needle thrust bearing for excessive wear or damage, and renew if necessary.

Refit

11. Reverse remove procedure in 7 to 9 to refit the components into free - wheel housing.

AUTOMATIC GEARBOX

Ensure that lip of free wheel 'arrowed' is positioned uppermost otherwise unit will be inoperative in use.

12. Refit first gear free - wheel housing assembly to gear train; use new locking plates, tighten retaining bolts and lock up locking plate tabs.
13. Re - fit free - wheel reaction member and input gear.
14. Refit gear train assembly, see **Primary drive gears**.
15. Refit engine/automatic gearbox assembly, see **ENGINE**.

KICK - DOWN CONTROL

Service Repair No. 44.15.01

Remove

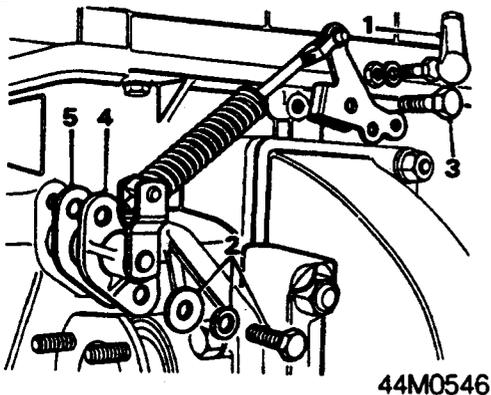

1. Disconnect governor kick - down control rod ball - end from control.
2. Remove two set screws and washers securing control to gearbox casing.
3. Remove pivot bolt securing control linkage to the gearbox casing.
4. Withdraw governor control out of gearbox.

Refit

5. Fit a new joint washer to control assembly, insert governor control lever into gearbox and positioned as shown illustrated.
6. Refit kick - down control securing screw and pivot bolt. Tighten kick - down control to gearbox casing securing screws to 0.7 Nm.
7. Re - connect governor kick - down control rod ball - end to control.

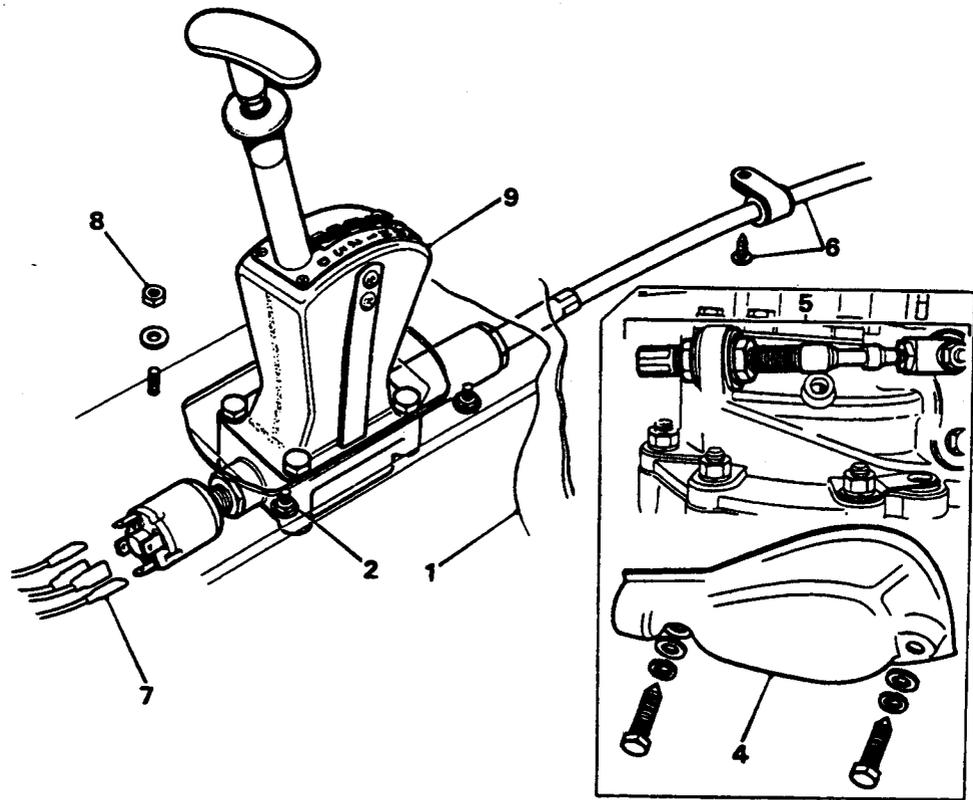

44M0547

SELECTOR MECHANISM ASSEMBLY

Service Repair No. 44.15.04

Service Repair No. 44.15.05 - Overhaul

Remove

1. Pull back the front floor covering
2. Slacken four nuts retaining selector mechanism mounting plate to floor panel.
3. Raise car on a hoist.
4. Remove bellcrank cover plate.
5. Disconnect selector cable from gearbox, see **Selector cable**.
6. Remove screw retaining cable clip to floor panel and pull cable clear of gearbox.
7. Note inhibitor switch wiring connections and disconnect wires.
8. Remove nuts retaining selector mechanism mounting plate to floor panel.
9. Remove selector mechanism with cable attached from car; note that a joint washer is fitted between mounting plate and floor panel.

AUTOMATIC GEARBOX

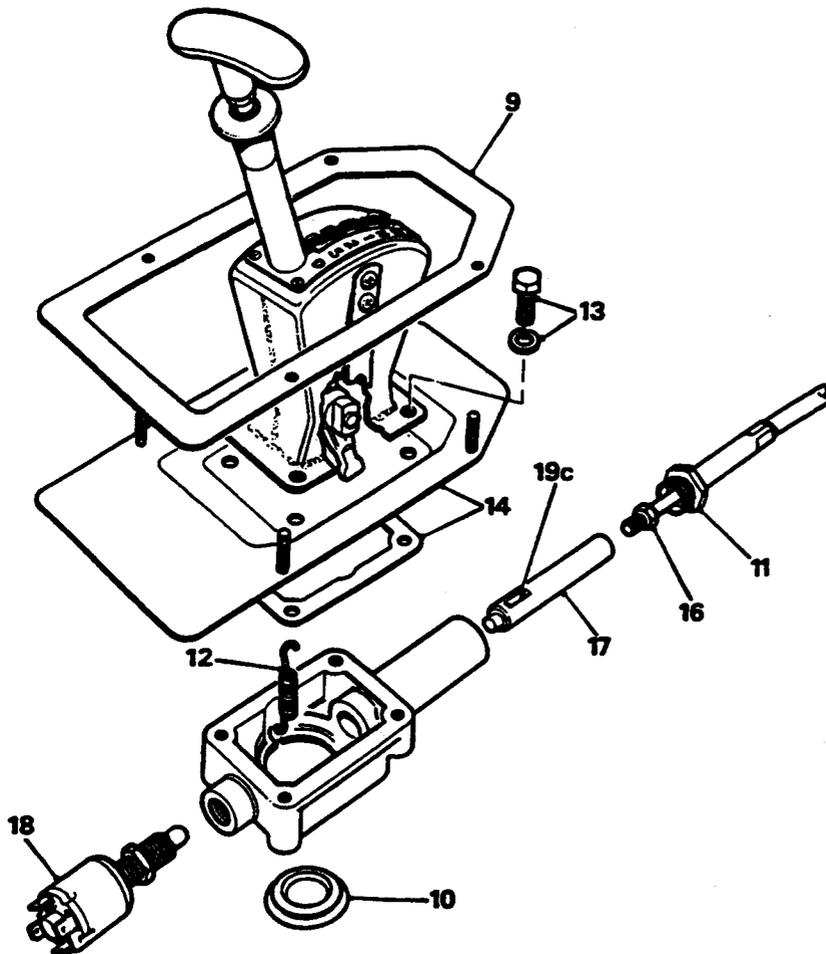

44M0548

Dismantle

10. Remove rubber grommet from base of selector mechanism housing and hold assembly in a vice.
11. Slacken nut retaining outer cable to housing.
12. Release reverse return spring from underside of housing.
13. Unscrew four screws retaining selector mechanism quadrant to housing.
14. Remove selector mechanism quadrant; lift off mounting plate and joint washer.
15. Unscrew outer cable out of housing with operating plunger attached.
16. Hold plunger with a screwdriver through slot, and slacken nut securing inner cable to plunger.
17. Unscrew plunger from selector cable.
18. Unscrew and remove inhibitor switch.

Refit

19. Reverse procedure in 1 to 18 noting following:
 - a Lubricate all moving parts with a graphite based grease.
 - b Screw inner cable fully into plunger and tighten nut.
 - c Fit plunger into housing with relieved side of slot uppermost to accept selector lever.
20. Adjust selector cable assembly, see **Adjustments**
21. Check that engine can **ONLY** be started when 'N' is selected, see **Adjustments**.

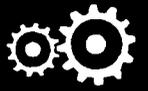

SELECTOR CABLE

Remove

1. Raise front of vehicle.

WARNING: Support on safety stands.

2. Position gear selector lever at 'P'.

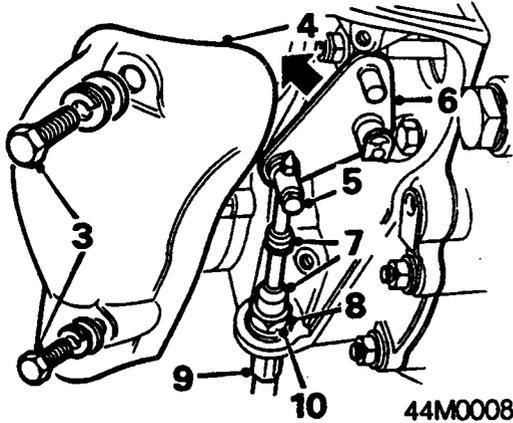

3. Remove 2 bolts, gear selector cable cover to gearbox.
4. Remove cover.
5. Slacken screw clamping gear selector cable.
6. Rotate bellcrank to disconnect selector cable from clamp.
7. Remove 2 rubber sleeves from cable.
8. Remove locknut, selector cable to gearbox.
9. Withdraw cable from gearbox.
10. Remove flat washer from cable.

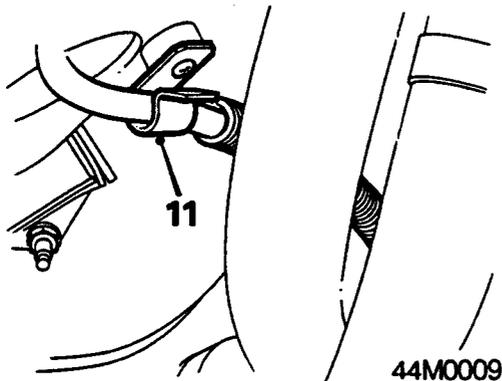

11. Release cable from clip.

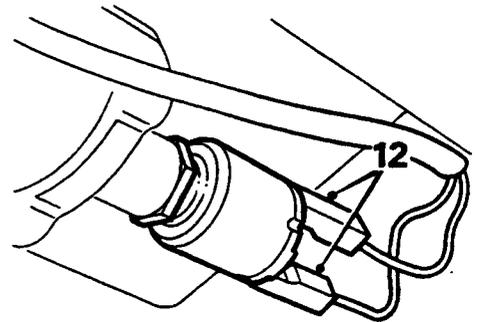

44M0010

12. Disconnect 2 Lucars from reverse light switch.

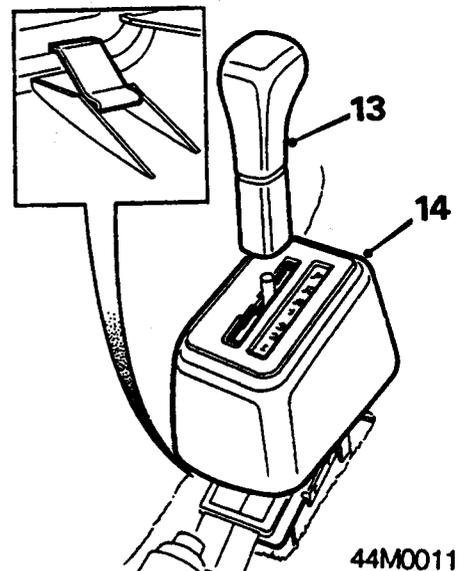

13. Unscrew knob from gear selector lever.
14. Lift off selector lever housing, noting 4 retaining clips which may become detached.

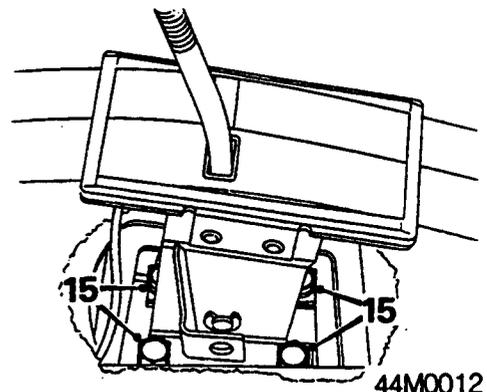

44M0012

15. Remove 4 bolts, selector lever housing to selector cable housing.

AUTOMATIC GEARBOX

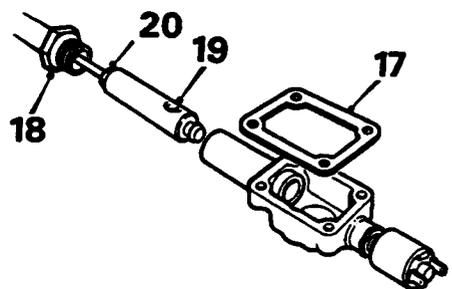

44M0013

16. Remove selector cable and cable housing from vehicle.
17. Remove gasket.
18. Unscrew selector cable from cable housing.
19. Withdraw cable and plunger from cable housing.
20. Slacken lock nut and unscrew inner cable from plunger.

Refit

21. Clean cable housing and grease cable.
22. Screw inner cable fully into plunger and tighten locknut.
23. Fit cable and plunger to cable housing and screw outer cable into housing. Tighten outer cable into housing.
24. Rotate inner cable to position cable plunger with relieved side of hole uppermost to accept selector lever.
25. Fit cable housing and gasket to vehicle.
26. Fit 4 cable housing bolts and tighten to 4 Nm.
27. Fit rubber sleeves to cable and insert inner cable into clamp.
28. Adjust selector cable, see **Adjustments**.
29. Fit selector cable cover, fit and tighten cover bolts.
30. Fit 4 retaining clips to slots inside selector lever housing and fit housing.
31. Fit selector cover knob.
32. Remove stand(s) and lower vehicle.
33. Carry out checking procedure to ensure selector cable adjustment is correct, see **Adjustments**.

STARTER INHIBITOR SWITCH

Service Repair No. 44.15.19

Remove

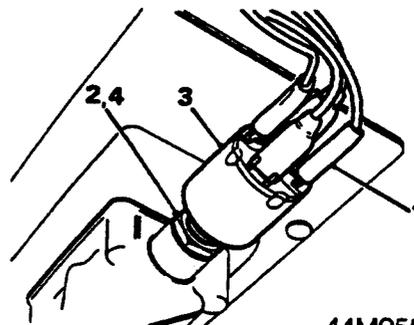

44M0551

1. Disconnect electrical connections at switch.
2. Release locking nut.
3. Unscrew and remove switch from selector mechanism housing.
4. Remove locking nut.

Refit

5. Position selector lever at 'N'.
6. Screw locking nut onto switch.
7. Screw switch into selector mechanism housing.
8. Adjust inhibitor switch, see **Adjustments**

CONVERTER HOUSING

Service Repair No. 44.17.01

Remove

1. Remove engine/automatic gearbox assembly, see **ENGINE**.
2. Remove converter, see **Converter assembly**.

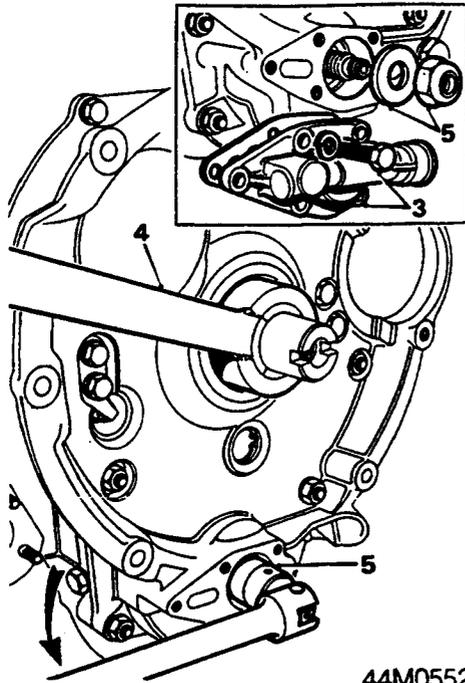

44M0552

3. Remove securing screws and detach low pressure valve from converter housing.
4. Fit **18G 1088** over converter output gear to hold crankshaft.
5. Remove input gear self-locking nut.
6. Remove two set screws securing bell-crank lever to converter housing.

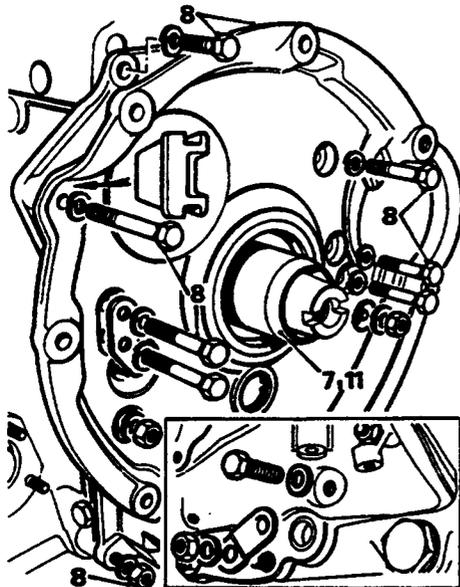

44M0553

7. Fit **18G 1098** over converter output gear.
8. Remove nuts and screws securing converter housing to power unit; withdraw housing partially and disconnect feed pipe from housing.
9. Remove housing and its joint washer.

Refit

10. Check that joint faces are clean and free from burrs; rectify as necessary and fit a new joint washer.
11. Ensure that **18G 1098** is still positioned on the converter output gear.
12. Refit converter housing, connecting feed pipe to housing. Ensure that feed pipe and the nylon pipe assembly at valve block are aligned then push the housing fully home. Remove tool **18G 1098**.
13. Refit securing nuts and screws; note that UNC threaded screws secure housing to gearbox casing while those threaded UNF screw into cylinder block.
14. Tighten screws and nuts to 25Nm.

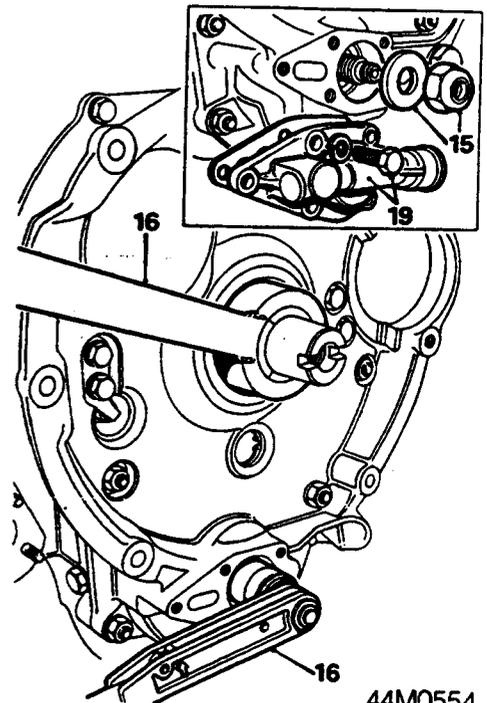

44M0554

15. Refit washer and self-locking nut to input gear shaft.
16. Use **18G 1088** to hold converter output gear, and tighten input shaft nut 95Nm.
17. Refit bell-crank lever.
18. Connect gear selector cable and adjust, see **Adjustments**
19. Refit low pressure valve with a new joint washer.
20. Refit converter, see **Converter assembly**.
21. Refit engine/automatic gearbox assembly, see **ENGINE**.

AUTOMATIC GEARBOX

CONVERTER HOUSING OIL SEAL

Service Repair No. 44.17.04

Remove - engine in car

1. Remove converter assembly, see **Converter assembly**.
2. Remove old seal, using 18G 1087; hook tool into oil seal groove and top outwards on tool, working round seal until removed.

Refit

CAUTION: New seal must be fitted to correct depth in order that drain hole 'arrowed' behind seal remains open.

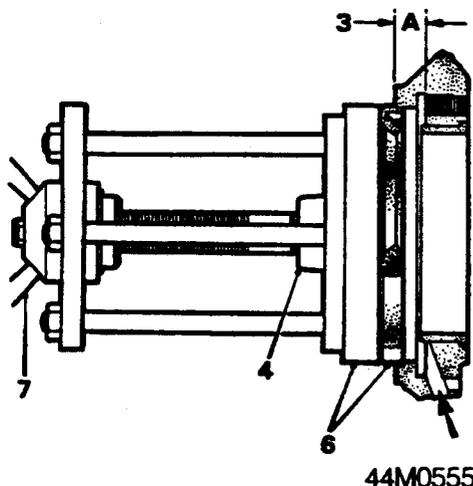

3. Take a depth measurement from any convenient point on the periphery of housing bore of front face of housing to undercut face 'A' illustrated. This measurement will be approximately 9.5mm, but should it be more or less than this measurement, this must be taken into account and either added to or subtracted from 9.5mm.

Example:

If measurement is 9.5mm, fit new seal to be flush with front face of converter housing.

If measurement is less than 9.5mm, fit seal proud of housing face by difference of measurement obtained.

Note: Converter housing face is not machined, therefore initial measurement position and that used when fitting a new seal must always be taken from same position on housing.

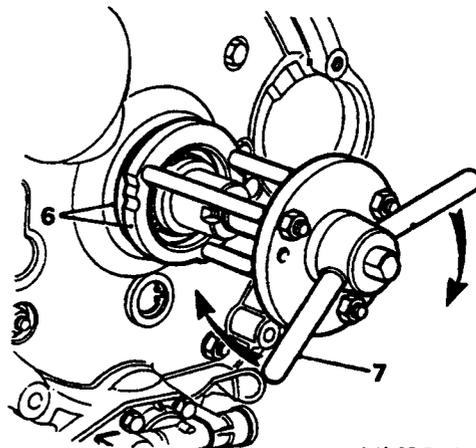

44M0556

4. Screw short threaded end of 18G 1068A securely into crankshaft.
5. Liberally lubricate new oil seal.
6. Assemble new seal together with 18G 1068B into position on housing as illustrated.
7. Screw in wing nut of tool until seal is pressed into housing to depth of measurement taken in procedure 3.
8. Remove 18G 1068B and 18G 1068A.
9. Refit converter assembly, see **Converter assembly**.

CONVERTER ASSEMBLY

Service Repair No. 44.17.07

Remove

1. Raise front of vehicle.

WARNING: Support on safety stands.

2. Fit engine lifting brackets to rocker cover securing nuts and support power unit.
3. Disconnect engine tie - rod from rear of cylinder block.
4. Disconnect exhaust pipe at manifold flange.
5. Remove oil filter bowl and head assembly, see **MAINTENANCE**.
6. Remove nuts and bolts securing right - hand engine mounting to sub - frame.
7. Raise rear of engine sufficiently to remove nuts and bolts securing starter motor and converter cover.
8. Disconnect and remove starter motor.
9. Turn converter cover slightly anti - clockwise and remove cover complete with engine mounting attached.

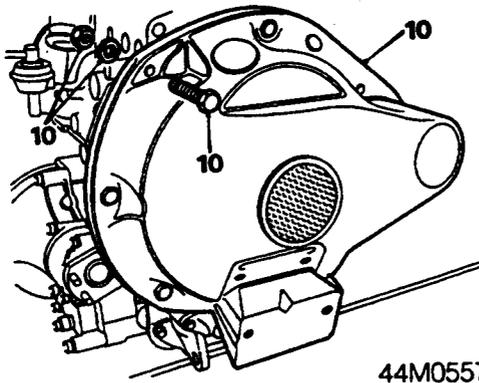
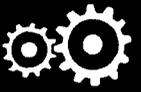

44M0557

10. Remove converter cover retaining bolts and nuts and lift off cover.

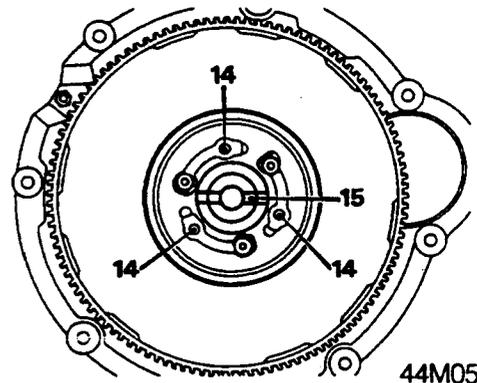

44M0559

14. Knock back locking tabs and remove three equally spaced set screws from converter centre.
15. Rotate converter until crankshaft slot is horizontal.
16. Insert plug of 18G 1086 into end of crankshaft.

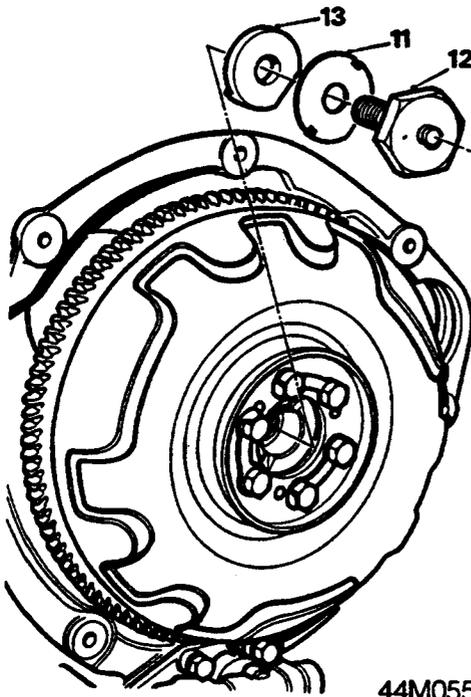

44M0558

11. Knock back lock washer tab from converter retainer bolt.
12. Hold converter from turning and remove converter retaining bolt, using 18G 587.
13. Lever out key plate locating converter to crankshaft.

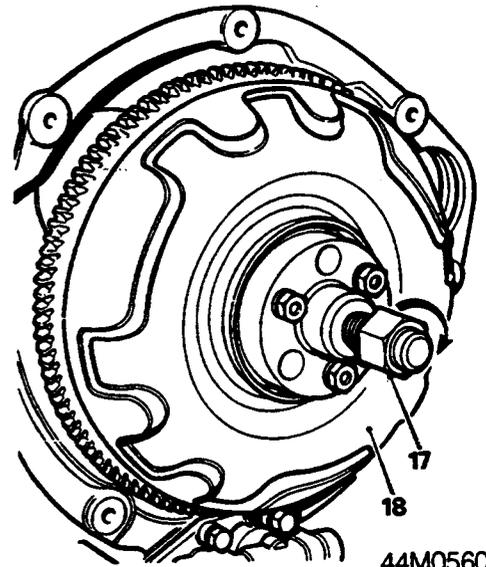

44M0560

17. Fit 18G 1086 onto converter and screw in centre bolt until converter is released from crankshaft taper; remove tool.
18. Lift off converter; note that it will still retain a quantity of oil.

AUTOMATIC GEARBOX

Refit

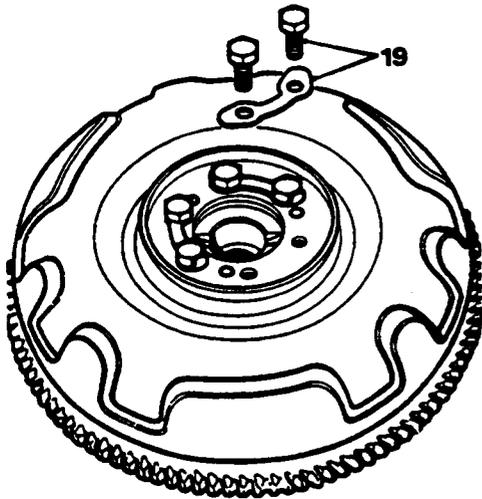

44M0561

19. Remove each pair of bolts in turn from converter centre and fit new locking plates. Tighten bolts to 30Nm and lock up locking tabs.

CAUTION: Do not remove all six screws from converter at one time.

20. Refit converter onto converter output gear and align offset slot of converter with slot in end of crankshaft.
21. Refit key plate into slot.
22. Fit converter retaining bolt with a new lock washer.
23. Hold converter from turning and tighten retaining bolt to 150Nm. tap over lock washer tab.
24. Refit converter cover.
25. Refit starter motor.
26. Refit oil filter assembly with a new joint washer, tighten bolts to 20Nm see **MAINTENANCE**.
27. Reverse procedure in 1 to 4.

PRIMARY DRIVE GEARS

Service Repair No. 44.17.10

Remove

1. Remove engine/automatic gearbox assembly, see **ENGINE**.
2. Remove converter assembly, see **Converter assembly**.
3. Remove converter housing, see **Converter housing**.

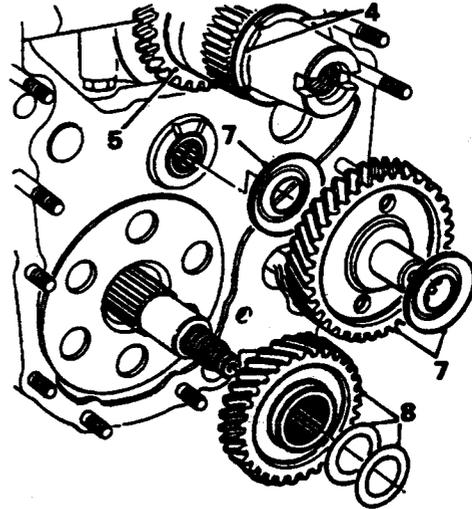

44M0562

4. Remove converter output gear rear thrust washer and backing ring.
5. Pull off converter output gear.
6. Remove output gear front thrust washer.
7. Remove idler gear and thrust washers.
8. Remove input gear and adjustment shims.

Note: Procedure for checking end - float adjustment of idler and converter output gears and pre - load adjustment of input gear is detailed below:

Adjust

9. Converter output gear: Refit output gear front thrust washer, with the chamfered side of washer (arrowed) towards crankshaft.
10. Refit converter output gear with its rear backing ring and rear thrust washer.



11. Check converter output gear end – float with feeler gauges; clearance should be between 0.099 to 0.16mm.

Adjust if necessary by selecting and fitting correct thickness thrust washer from range given below.

Converter output gear thrust washer chart

- 2.85 to 2.90mm
- 2.90 to 2.95mm
- 2.95 to 3.0mm
- 3.0 to 3.05mm

12. Remove converter output gear after adjustment.

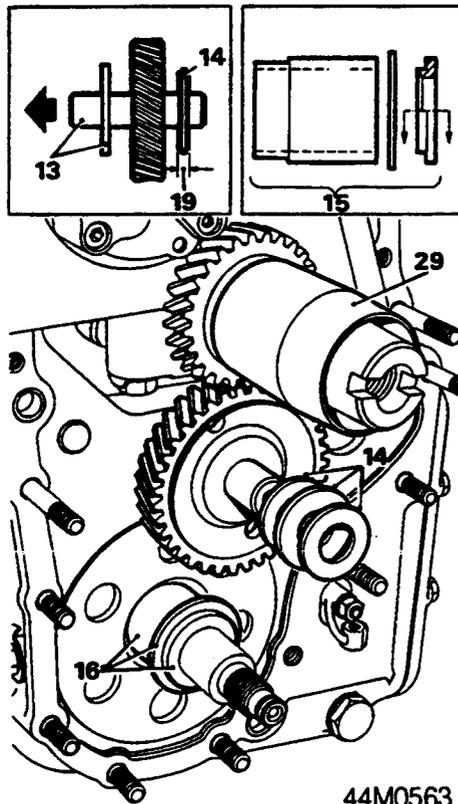

44M0563

13. *Idler and input gears:* Assemble idler gear to gearbox with a thrust washer on gearbox side of gear.
14. Use larger washers of 18G 1089 with a dental wax washer interposed between the two and fit onto converter housing side of idler gear.
15. Cut a dental wax washer and interpose it between 18G 1089 A and 18G 1089/1; this assembly replaces input gear for checking pre – load adjustment.
16. Fit 18G 1089A and 18G 1089/1 with wax washer onto input gear shaft.
17. Fit a new converter housing joint washer; refit housing and tighten retaining bolts and nuts to 25Nm. Do not fit output shaft nut.
18. Remove converter housing.
19. Remove idler gear and washers. Measure total thickness of thrust washer and 18G 1089 with its wax washer.

Subtract 0.10 to 0.18mm from the total thickness of measurement taken to obtain correct idler gear end – float.

20. Select two washers of approximately equal thicknesses from range given below:

Idler gear thrust washer chart

- 3.30 to 3.32mm
- 3.35 to 3.37mm
- 3.40 to 3.42mm
- 3.45 to 3.47mm
- 3.50 to 3.53mm

21. Fit selected thrust washers onto and refit idler gear.
22. *Input gear pre – load:* Remove dummy input gear (18G 1089A and 18G 1089/1 with wax washer) from input gear shaft, keep complete assembly together and place to one side.

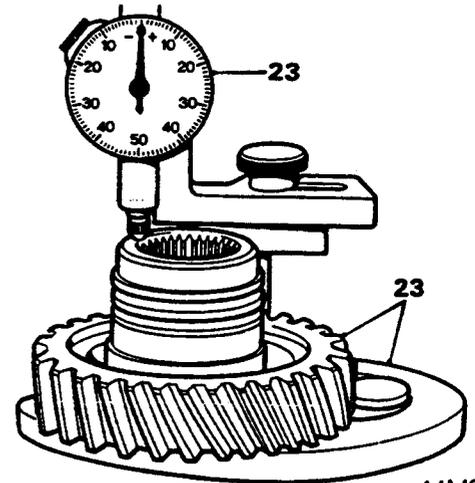

44M0564

23. Place input gear onto a surface plate or onto 18G 191A and use dial test indicator gauge to take a mean reading. Set dial test indicator gauge to zero as illustrated.

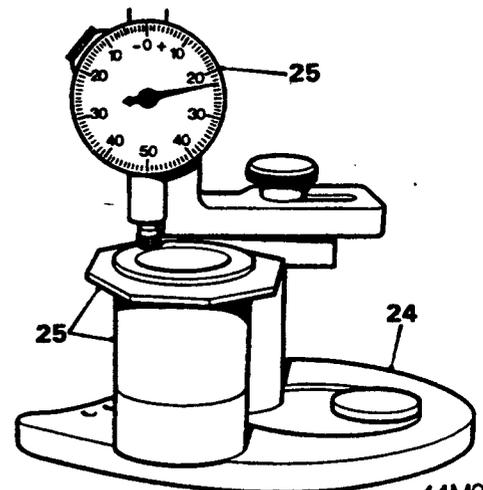

44M0565

24. Remove input gear, and substitute complete assembly removed in procedure 22 onto 18G 191A or a surface plate.
25. Check additional thickness measurement of this assembly.

AUTOMATIC GEARBOX

Mean reading obtained on dial test indicator gauge indicates total thickness of adjustment shims required to eliminate end - float.

To this figure, add a shim thickness of 0.025 to 0.07mm to give required input bearing pre - load adjustment.

Select required thickness of shims from chart.

Input gear shims

0.07mm

0.30mm

Refit

26. Refit input gear and shims.
27. Remove housing joint washer used for 'Adjust' procedure and fit a new one.
28. Refit converter output gear and thrust washers.
29. Fit 18G 1098 over output gear.
30. Refit converter housing, see **Converter housing**.
31. Refit converter assembly, see **Converter assembly**.
32. Refit engine/automatic gearbox assembly, see **ENGINE**.

DATA

Converter output gear

end - float 0.09 to 0.16mm

Idler gear end - float . 0.10 to 0.18mm

Input gear pre - load . 0.02 to 0.07mm

GEARBOX ASSEMBLY

Service Repair No. 44.20.01

Remove

1. Remove engine/automatic gearbox assembly, see **ENGINE**.
2. Drain oil.
3. Remove oil filter assembly.
4. Remove starter motor.
5. Remove securing nuts and bolts and detach converter end - cover.
6. Knock back lock washer on converter retaining bolt.
7. Hold converter from turning and use 18G 587 to remove converter retaining bolt.
8. Remove key plate locating converter to crankshaft.
9. Turn converter until end slot is horizontal.
10. Knock back locking tabs and remove three equally spaced set screws from converter centre.

CAUTION: Do not remove all six set screws at one time.

11. Locate plug adapter of 18G 1086 into end of crankshaft.
12. Screw 18G 1086 onto converter, hold converter from turning and screw in centre bolt of tool to release converter from crankshaft taper.
13. Lift off converter and remove tool. Note that converter will still retain a quantity of oil.

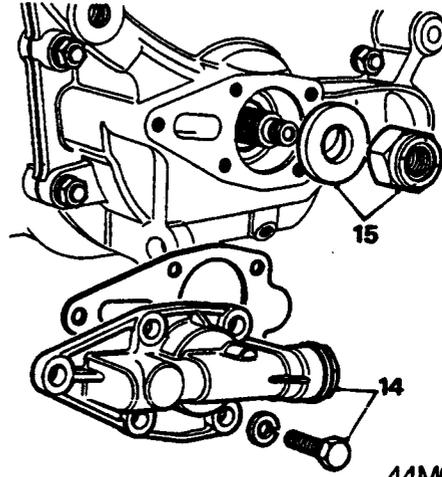

14. Remove low pressure valve retaining screws and detach the valve.
15. Hold converter output gear with tool 18G 1088 and remove input gear self - locking nut and washer.
16. Remove two set screws securing bell - crank lever to converter housing.
17. Remove rubber block (grommet) from converter housing.
18. Remove set screws, nuts, and spring washers securing the converter housing to power unit.
19. Locate 18G 1098 over converter output gear.
20. Withdraw converter housing.
21. Disconnect external engine oil feed pipe from adapter on gearbox casing.
22. Lever main oil feed pipe from oil pump and gearbox casing.
23. Remove nuts and set screws securing engine to gearbox.
24. Fit suitable lifting equipment to engine and lift engine away from gearbox.

Inspect

25. Ensure that all joint faces are clean and free from burrs.
26. Check that all oil seals and 'O' rings are in perfect condition, and fit replacements where required to following components:
 - a Oil feed pipe 'O' rings (pump to block).
 - b Main oil strainer pick - up pipe 'O' ring.
 - c Front main bearing cap oil seal.

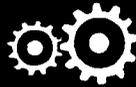

Refit

27. Grease joint faces of engine crankcase and locate new joint washers into position.
28. Position front main bearing cap oil seal on transmission case.
29. Lower engine onto gearbox and start retaining nuts and spring washers onto studs before completely lowering engine onto gearbox; tighten all retaining nuts evenly and trim off any excess joint from rear of unit.
30. Connect up and tighten external oil feed pipe.
31. Refit internal oil feed pipe into its locations in the oil pump and cylinder block.
32. Fit a new converter housing joint washer to power unit.
33. Fit **18G 1098** over converter output gear.
34. Refit converter housing and ensure that converter outlet pipe is in alignment with nylon guide so that pipe will enter valve block pipe chest. Tighten housing retaining bolts and nuts to 25Nm.

Note:

a UNC screws are fitted into gearbox casing.
 b Screw with copper washer is fitted adjacent to transverse selector rod.

35. Fit **18G 1088** onto converter output gear.
36. Refit input shaft washer and Nyloc nut, hold converter output gear from turning with **18G 1088** and tighten retaining nut to 95Nm. Remove **18G 1088**.
37. Refit low pressure valve with a new joint washer

tighten bolt with **18G 587** tap over lock washer tab.

41. Insert rubber block into its location in converter housing and refit converter end cover.
42. Refit gear selector bell – crank lever.
43. Refit starter motor.
44. Refit engine oil filter assembly, see **ENGINE**.
45. Refit engine/automatic gearbox assembly, see **ENGINE**.
46. Refill engine/automatic gearbox with oil, see **MAINTENANCE**.

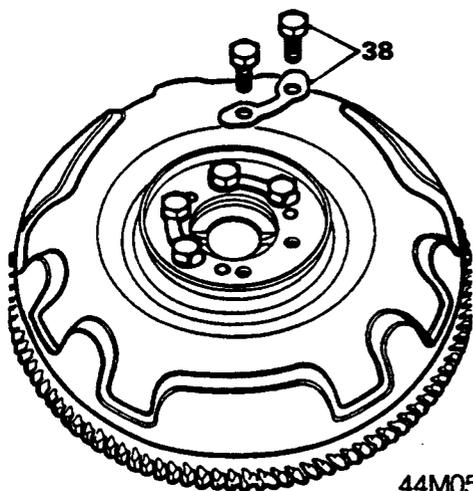

44M0567

38. Remove each pair of bolts in turn from converter centre and refit them with new locking plates. Tighten bolts to 30Nm, tap over lock washer tabs.

CAUTION: Do not remove all six bolts from converter centre at one time.

39. Refit converter and align offset slot with slot on crankshaft; insert locating key plate.
40. Refit converter retaining bolt with a new lock washer, hold converter from turning and

AUTOMATIC GEARBOX

GEARBOX ASSEMBLY - OVERHAUL

Service Repair No. 44.20.06

Dismantle

1. Remove engine/automatic gearbox assembly, see **ENGINE**.
2. Remove gearbox assembly from engine, see **Gearbox assembly**.

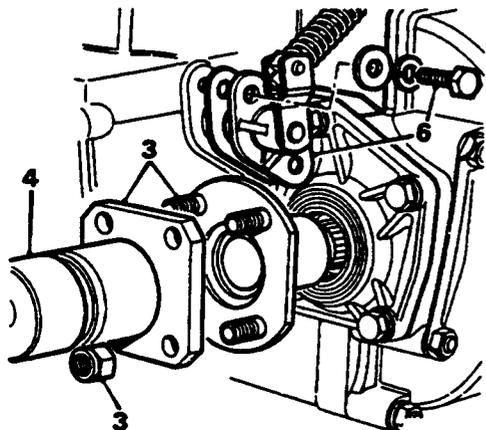

44M0568

3. Fit 18G 284 - 4 adapter to differential driving flange and secure with drive shaft universal joint nuts.
4. Screw tool 18G 284 onto 18G 284 - 4 and impact driving flange off splined shaft.
5. Repeat procedure in 3 and 4 to remove other driving flange.
6. Remove securing screws and detach kick-down control assembly.

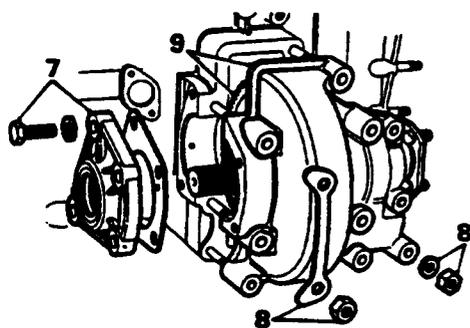

44M0569

7. Remove differential end cover securing screws and remove cover.
8. Release locking plate tabs and remove differential/final drive housing securing nuts.
9. Withdraw housing and final drive assembly.

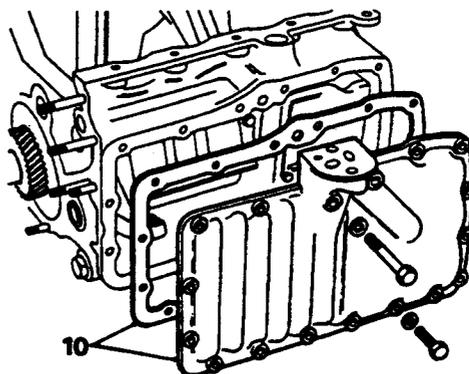

44M0570

10. Remove front cover securing screws and detach cover.

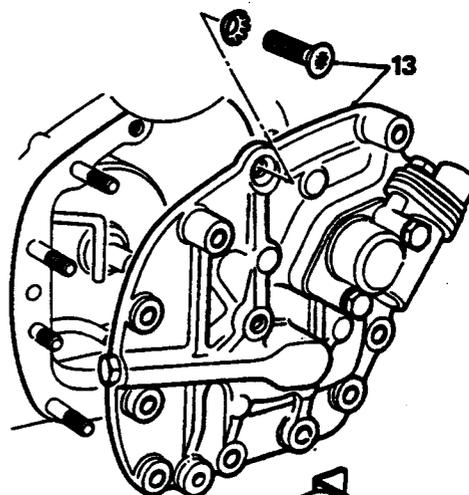

44M0571

11. Remove securing nuts and detach engine mounting casting from governor housing.
12. Fit 18G 1097 to hold forward clutch in place.
13. Remove governor housing securing screw and nuts and withdraw housing assembly.

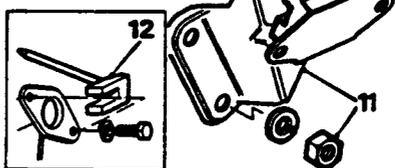

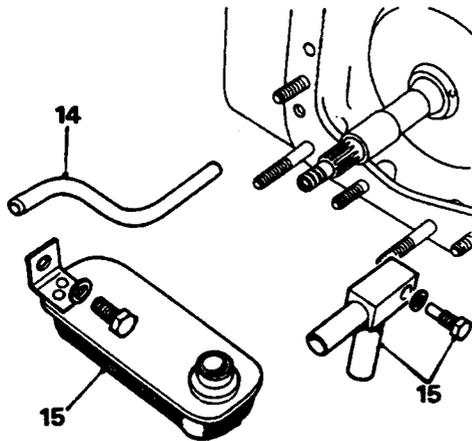
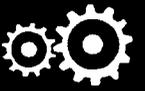

44M0572

14. Pull out forward clutch feed pipe.
15. Remove dowel bolt and set screw securing pick - up pipe and oil strainer and lift out strainer assembly.
16. Remove 18G 1097 and withdraw forward clutch assembly.

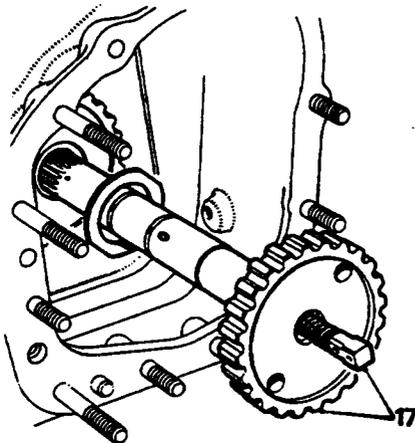

44M0573

17. Pull out forward output shaft; note reverse shut - off valve located in end of shaft.

AUTOMATIC GEARBOX

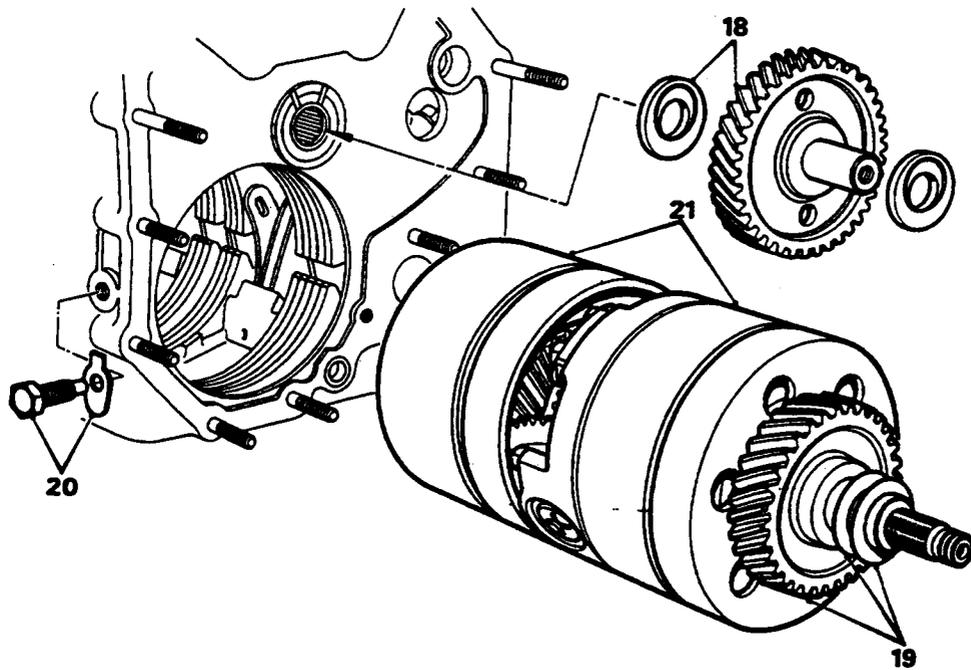

44M0574

18. Remove idler gear and thrust washers.
19. Remove input gear with its pre - load adjustment shims.
20. Tap back lock washer tab of dowel bolt retaining the gear train.
21. Pull out gear train assembly complete with top and reverse clutch.
22. Unscrew and pull out transverse selector rod.

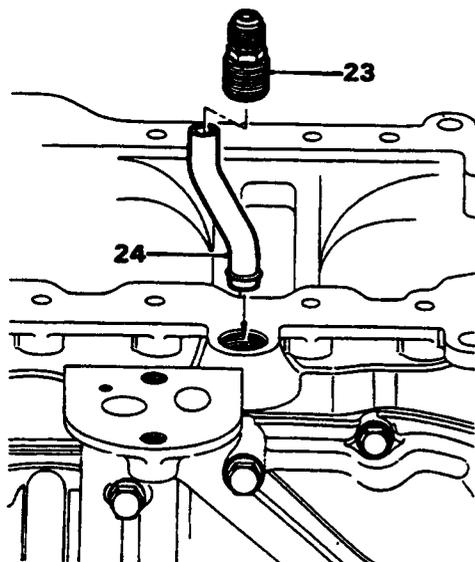

44M0575

23. Unscrew and remove engine oil feed pipe adapter.
24. Withdraw shaped copper pipe through adapter hole.

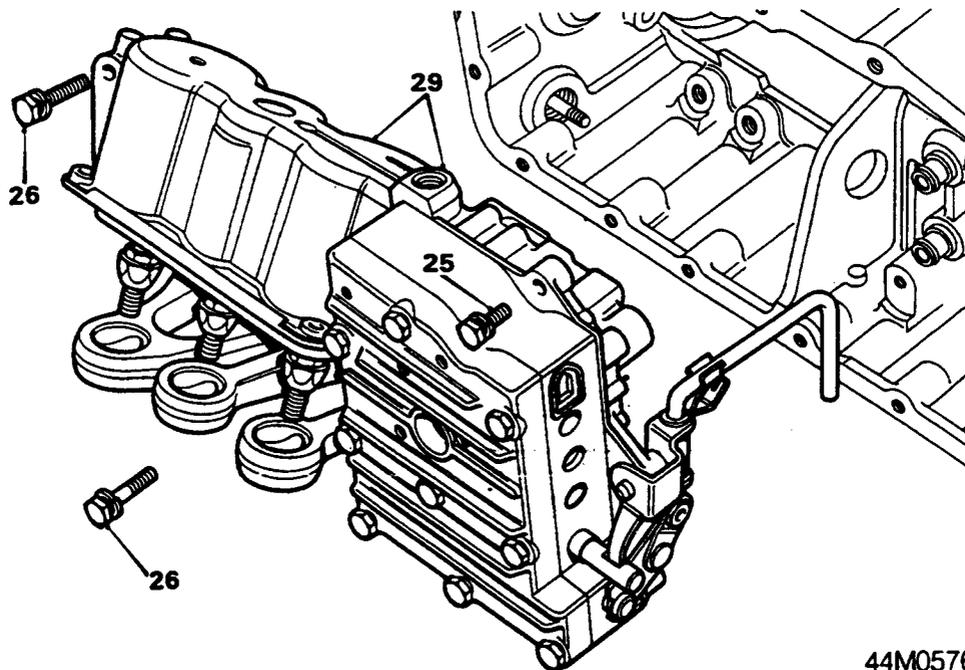
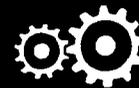

44M0576

- 25. Remove valve block retaining bolts.
- 26. Remove servo unit retaining bolts.
- 27. Unhook brake bands from servo reaction levers and struts.
- 28. Remove brake bands from casing.
- 29. Remove servo unit and valve block as a complete assembly.
- 30. Remove needle thrust bearing and washer which will have remained in top and reverse clutch hub when gear train assembly was removed.

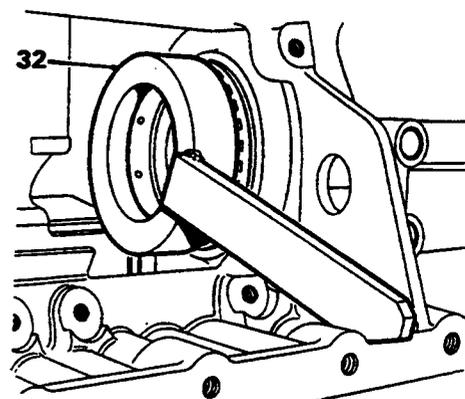

44M0578

- 32. Use 18G 1095 to hold top/reverse splined hub, and remove hub retaining nut with 18G 1096.

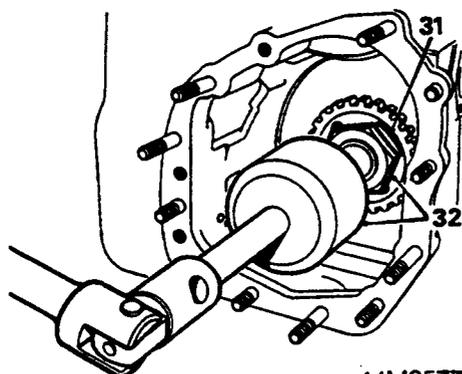

44M0577

- 31. Knock back lock washer tabs on forward clutch splined hub nut.

AUTOMATIC GEARBOX

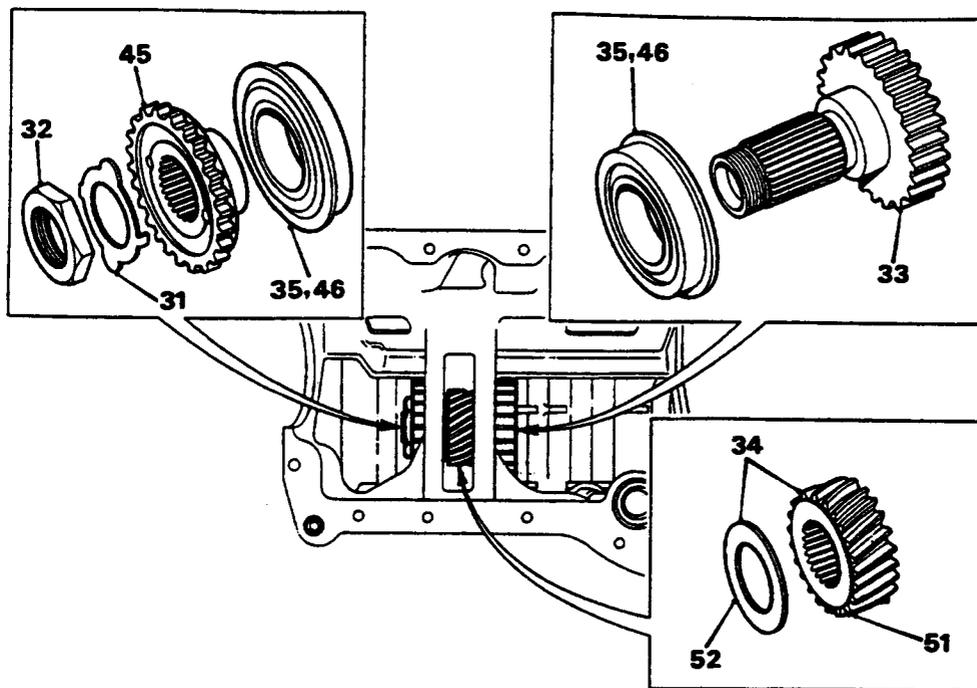

44M0579

33. Drift top/reverse clutch hub out of centre web of the gearbox casing.
34. Remove final drive gear pinion with its selective thrust washer.
35. Drift out both bearings from opposing sides of centre web. Drift bearings on their outer race so that each bearing will be removed in one piece.

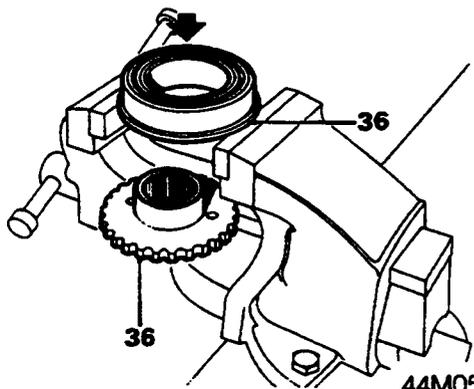

44M0580

36. Support extreme outer edge of bearing on a vice and drift out forward clutch splined hub.

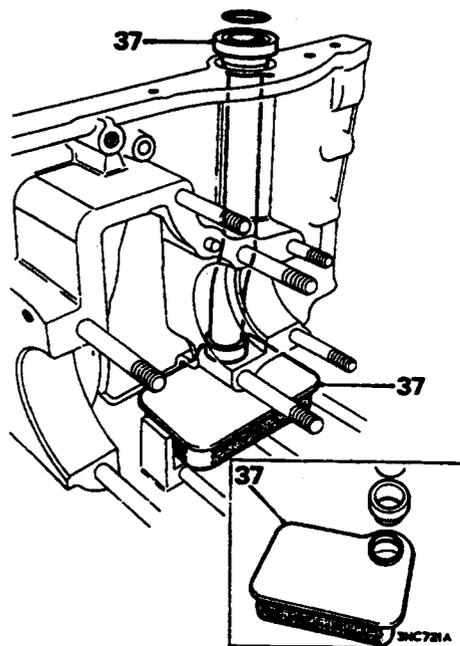

44M0581

37. Withdraw main oil pick - up pipe and remove strainer.

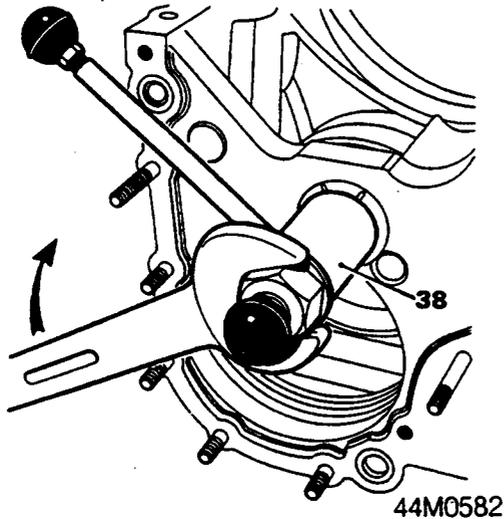

38. Use 18G 581 to withdraw idler gear needle roller bearing out of gearbox casing.

Inspection

39. Absolute cleanliness is essential; use fuel (petrol) or paraffin (kerosene) where necessary for cleaning. Dry the components with an air pressure line or use lint-free rag.
40. Dismantle each particular unit or assembly and overhaul it following procedure given; reference will be made in 'Reassembling' sequence to operation number covering overhaul procedure for each particular assembly.
41. All 'O' rings and seals should be renewed; inspect all cast iron sealing rings for wear or sideways movement in their locating grooves, and renew as necessary.
42. Examine all joint faces for burrs or damage and rectify as necessary. Always fit new joint washers, lock washers and locking plates.
43. Immerse all 'O' rings and seals in clean engine oil prior to reassembling each unit, and ensure that they are well lubricated when rebuilding gearbox assembly. Use petroleum jelly where necessary when reassembling to secure thrust washers and races in position.

Reassemble

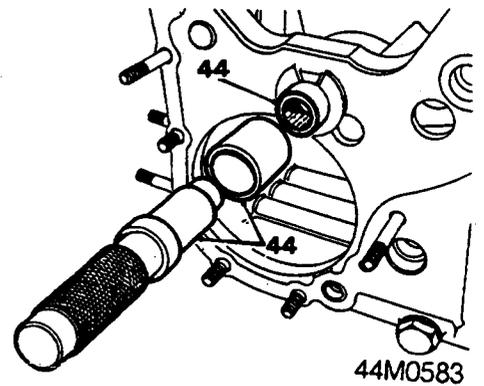

44. Refit idler gear needle roller bearing using 18G 1126. Drift bearing into casing as far as sleeve on tool will allow.
45. Drift forward clutch splined hub into its bearing.

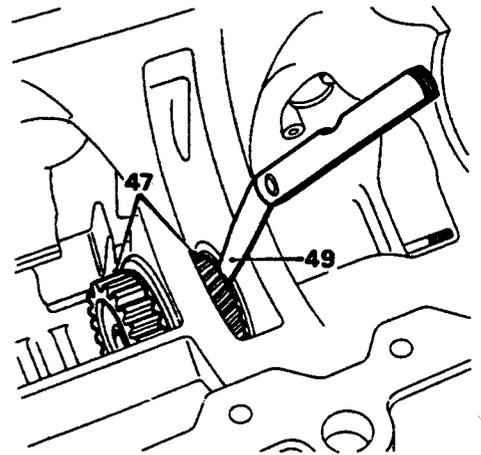

46. Refit top/reverse clutch hub bearings into centre webs of gearbox casing. Drift each bearing on its outer cage until bearing register contacts casing web.
47. Refit top/reverse clutch hub, together with final drive gear pinion but without selective shim washer.
48. Lightly tighten clutch hub retaining nut until light friction is felt on bearings when rotating hub.
49. Check with feeler gauges gap existing between final drive gear pinion and forward clutch hub bearing face.
50. From gap measurement taken subtract 0.05mm and select a shim washer of this thickness from range available.
51. Remove retaining nut and drift out top/reverse clutch hub and withdraw final drive gear pinion.
52. Smear selected shim washer with petroleum jelly and stick it onto forward clutch side of pinion for assembly purposes.
53. Refit complete assembly and fit a new top/reverse clutch hub nut lock washer. Use 18G 1095 to hold hub, and tighten

AUTOMATIC GEARBOX

top/reverse hub nut with 18G 1096 to 200Nm.

54. Check that there is only light friction on bearings when rotating hub; bearing pre-load is 0.05mm. Tap over lock washer tabs.
55. Insert three brake bands into casing and place them in their fitted positions.
56. Overhaul servo assembly, see **Servo assembly - Overhaul**.
57. Overhaul valve block assembly, see **Valve block assembly**.

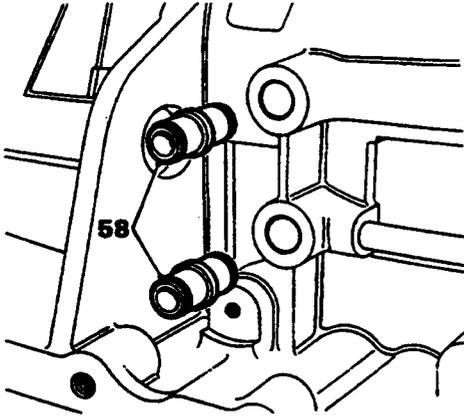

44M0585

58. Refit two valve block connections into gearbox casing.
59. Assemble valve block and servo unit as an assembly and refit it into gearbox casing.
60. Refit and tighten servo unit securing bolts to 23Nm.
61. Refit and tighten valve block securing bolts to 14Nm.
62. Locate brake bands onto servo unit reaction levers and struts.
63. Screw transverse selector rod fully into valve block linkage.
64. Overhaul top and reverse clutch, see **Top and reverse clutch - Overhaul**.
65. Overhaul first gear free-wheel, see **First gear free-wheel assembly**.
66. Reassemble overhauled assemblies onto gear train, check that faces of reverse output shaft and top/reverse clutch are level, see **Top and Reverse Clutches**
67. Refit stepped thrust washer onto end of top/reverse clutch with petroleum jelly.
68. Smear petroleum jelly onto thrust bearing and secure them in position in top/reverse clutch hub in gearbox casing.
69. Refit forward output shaft with its reverse shut-off valve.
70. Refit gear train assembly into gearbox. Use hand pressure only to push it into position; quick rotation of the input gear backwards and forwards will assist engagement of the top and reverse clutch friction plates with

top and reverse clutch hub splines.

Note: When correctly assembled, dowel bolt will engage easily in free-wheel reaction member.

71. Fit a new lock washer, refit and tighten dowel bolt and tap over lock washer tab.
72. Carry out brake band Adjust procedure, see **Adjustments**.
73. Overhaul forward clutch assembly, see **Forward clutch - Overhaul**.
74. Refit forward clutch and ensure that clutch plates engage forward clutch hub splines. Rotate clutch assembly backwards and forwards to assist engagement; when correctly fitted, there is only a small clearance between the forward clutch and centre web of gearbox casing.

CAUTION: If clutch is not fully engaged on hub splines, flange of governor housing will not contact gearbox casing; any excessive force used may damage clutch plates.

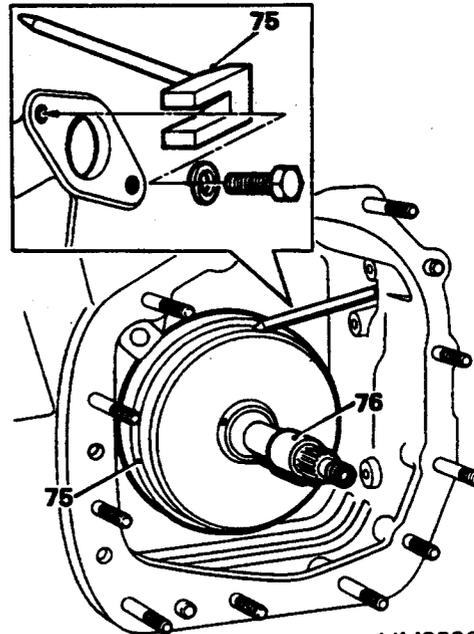

44M0586

75. Use 18G 1097 to hold forward clutch securely in position until governor housing has been refitted.
76. Pull nylon assembly sleeve back over rings on the forward clutch shaft; it will become safely displaced along shaft when governor housing is refitted.
77. Refit auxiliary oil strainer assembly and secure with set screw and dowel bolt locating pick-up pipe.
78. Refit forward clutch feed pipe (long end into gearbox casing).
79. Overhaul governor housing assembly, see **Governor housing - Overhaul**.

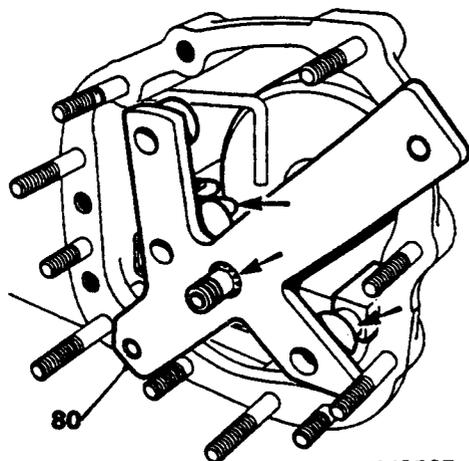

44M0587

80. Locate 18G 1094 onto gearbox casing dowels and align pipes and forward clutch shaft; remove tool.

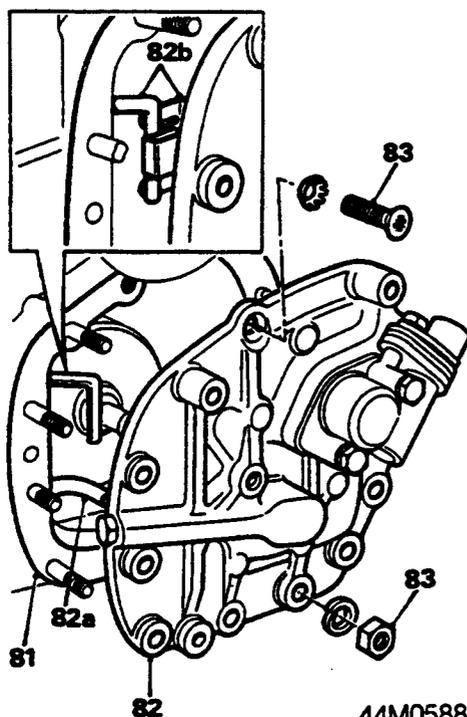

44M0588

81. Fit a new joint washer coated with Hylomar jointing compound (or equivalent) onto casing.
82. Refit governor housing giving particular attention to the following points as housing is being pushed onto studs:
- Check that forward clutch feed pipe has started to engage its location in housing.
 - Check that governor valve linkage engages correctly between two forks and spring clip drive of the governor unit.
83. Tighten governor housing securing nuts and screw to 18Nm.
84. Remove forward clutch holding 18G 1097.
85. Refit engine mounting casting to governor housing.

86. Refit main oil pick - up pipe and strainer.
87. Refit and adjust differential assembly, see **DIFFERENTIAL**.
88. Refit idler gear and thrust washers.
89. Refit input gear with its adjustment shims.
90. Refit gearbox to engine, see **gearbox assembly**.
91. Fit a new joint washer coated with Hylomar jointing compound (or equivalent) and refit front cover.

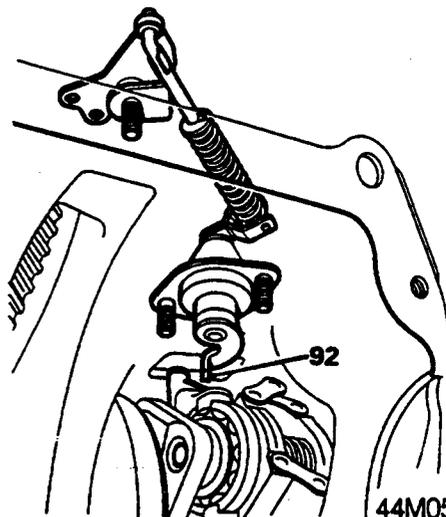

44M0589

92. Refit kick - down control assembly with lever positioned as illustrated.
93. Refit engine/automatic gearbox assembly, see **ENGINE**.

DATA

Top/reverse clutch	
hub bearing pre - load	0.05mm
Brake band	
adjustment	1.02 to 1.03mm
Input gear bearing	
pre - load	0.02 to 0.08mm
Idler gear end - float .	0.10 to 0.18mm

AUTOMATIC GEARBOX

GOVERNOR HOUSING ASSEMBLY

Service Repair No. 44.22.01

Remove

1. Remove engine/automatic gearbox assembly, see **ENGINE**.
2. Drain engine/automatic gearbox oil, see **MAINTENANCE**.
3. Remove radiator assembly from engine, see **COOLING SYSTEM**.

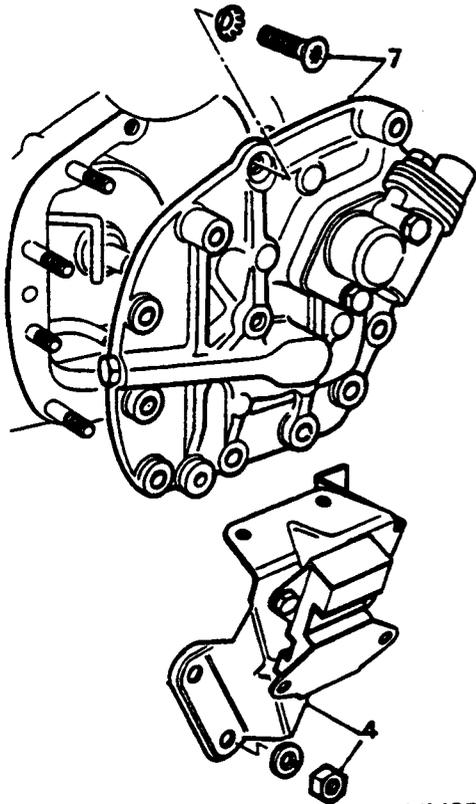

4. Remove securing nuts and detach engine mounting adapter bracket complete with mounting attached from governor housing.

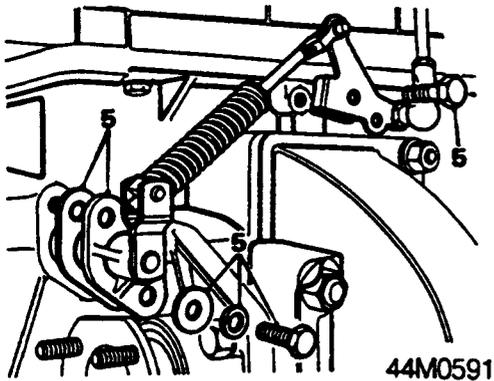

5. Remove screws and detach kick-down control assembly from gearbox casing.

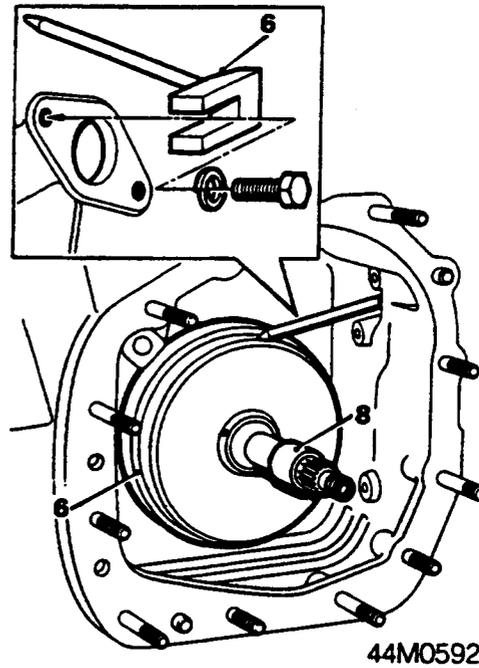

6. Fit tool 18G 1097 to retain position of forward clutch.

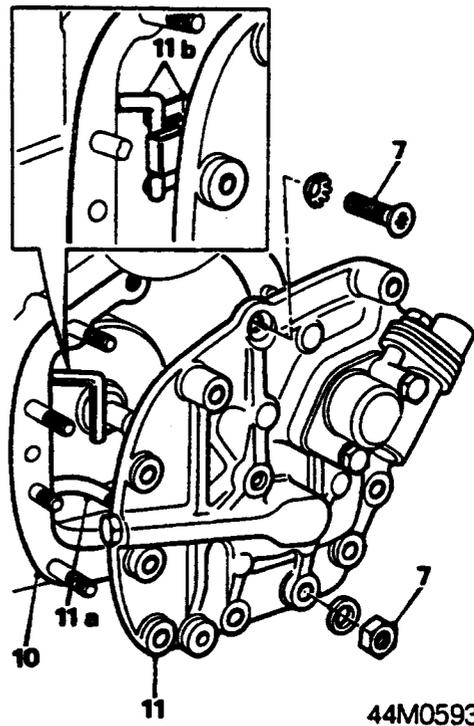

7. Remove securing nuts and withdraw governor housing assembly.

Refit

8. Pull nylon assembly sleeve back over rings on forward clutch shaft, it will become safely displaced along shaft when governor housing is refitted.

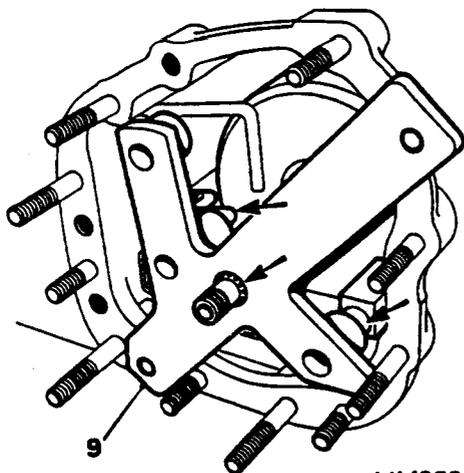
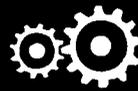

44M0594

9. Locate tool 18G 1094 onto gearbox casing dowels and align pipes and forward clutch shaft; remove tool.
10. Smear or spray Hylomar jointing compound (or equivalent) onto new joint washer and fit it to gearbox casing.
11. Refit governor housing giving particular attention to the following points as housing is being pushed onto studs:
 - a Check that forward clutch feed pipe has started to engage its location in housing.
 - b Ensure that governor valve linkage engages correctly with spring clip drive of governor as housing is pushed on. Link engages between two forks and spring clip and **THAT** is its operating position; it **MUST NOT** enter into centre open portion of clip.
12. Tighten governor housing bolts to 18Nm.
13. Refit engine mounting adapter plate to governor housing.
14. Remove tool 18G 1097.

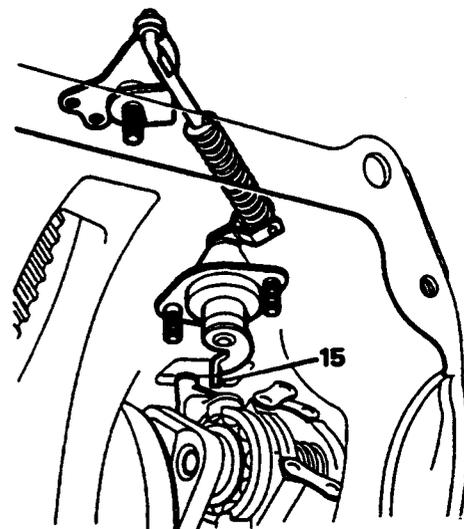

44M0595

15. Refit kick - down control and tighten securing screws to 7 Nm.
16. Refit radiator assembly, see **COOLING SYSTEM**.
17. Refit engine/automatic gearbox assembly, see **ENGINE**.
18. Refill engine/automatic gearbox with oil, see **MAINTENANCE**.

AUTOMATIC GEARBOX

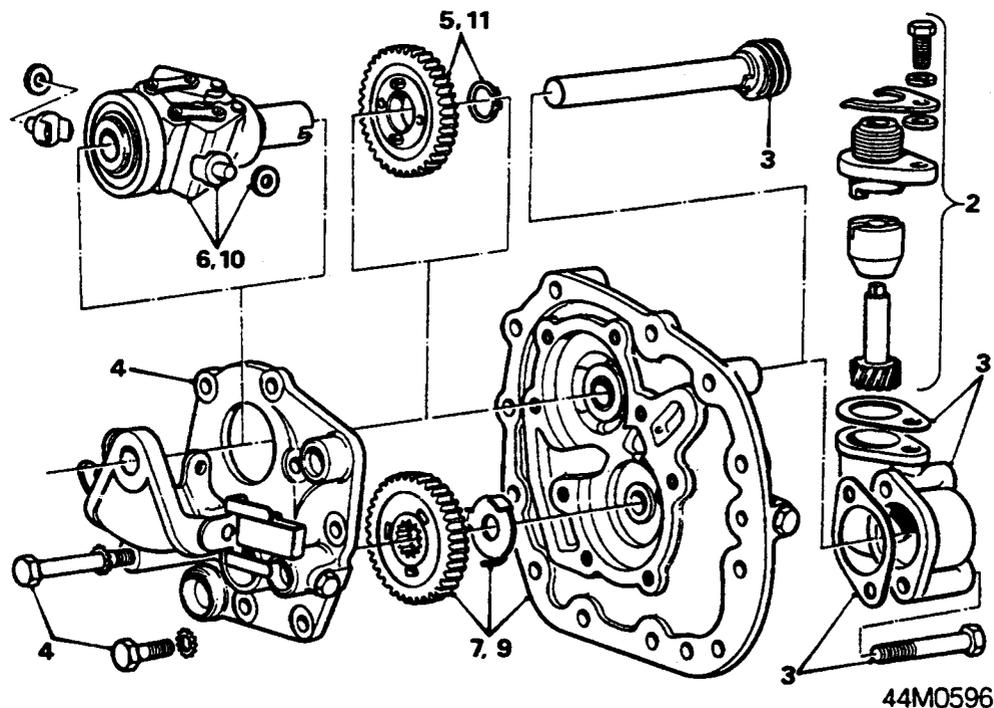

GOVERNOR ASSEMBLY - OVERHAUL

Service Repair No. 44.22.04

Dismantle

1. Remove governor housing assembly, see **Governor housing assembly**.
2. Remove one screw and withdraw speedometer drive pinion components.
3. Remove two securing screws, detach pinion housing and withdraw speedometer drive gear.
4. Remove set screws and bolt securing governor mounting plate and remove it from end housing.
5. Remove circlip and withdraw gear off governor shaft.
6. Remove governor unit with its bearing retaining trunnions and washers.
7. Remove second auxiliary pump gear and steel thrust washer from governor housing end - cover.

Inspection

8. Examine all components for wear or damage; renew the governor assembly if bearing requires replacement. Renew gear and casing assemblies as necessary.

Reassemble

9. Reassemble gear and thrust washer into governor housing end cover.
10. Refit governor assembly with its retaining trunnions and washers to mounting plate.

11. Refit other gear and circlip onto governor assembly.

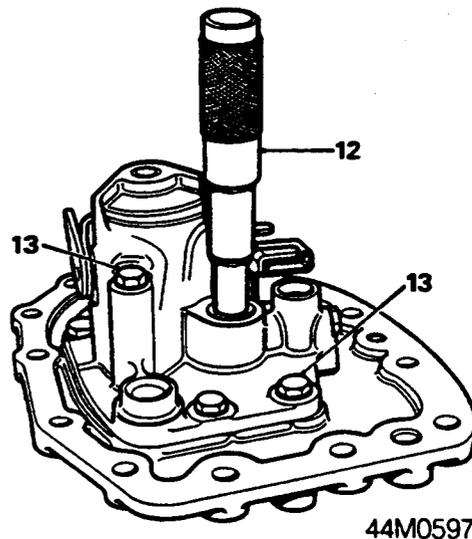

12. Refit two housing assemblies together and centralise the assemblies and gear with **18G 1106**.
13. Tighten retaining screws and bolt to 18Nm, and remove **18G 1106**.
14. Insert speedometer drive gear through end housing and governor unit.
15. Refit pinion housing with a new joint washer and refit pinion assembly.
16. Refit governor housing assembly, see **Governor housing assembly**.

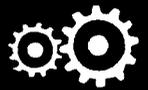

OIL PUMP

Service Repair No. 44.32.01

Remove

1. Remove engine/automatic gearbox assembly, see **ENGINE - Repairs**.
2. Remove converter assembly, see **Converter assembly**.
3. Remove converter housing, see **Converter housing**.
4. Withdraw oil feed pipe from pump to gearbox casing.

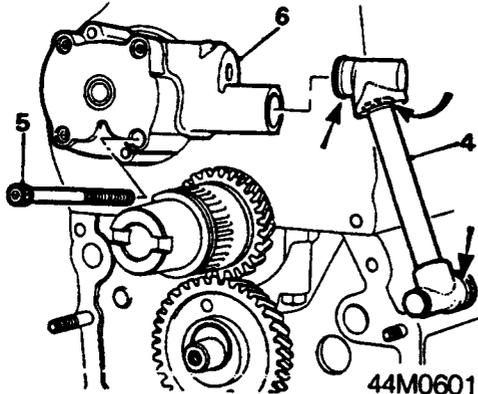

5. Use an Allen key and remove oil pump retaining screws.
6. Remove oil pump assembly; pump drive coupling may also be attached or it may stay in end of camshaft.

Refit

7. Renew oil pump joint washer and ensure that it is correctly fitted.
8. Refit pump with splined shaft engaging drive coupling; refit and tighten retaining screws.
9. Check oil seals on and in oil feed pipe 'arrowed', and renew as required.
10. Refit oil feed pipe.
11. Refit converter housing, see **Converter housing**.
12. Refit converter assembly, see **Converter assembly**.
13. Refit engine/automatic gearbox assembly, see **ENGINE - Repairs**.

OIL PUMP - OVERHAUL

Service Repair No. 44.32.04

Dismantle

1. Remove oil pump, see **Oil pump**.

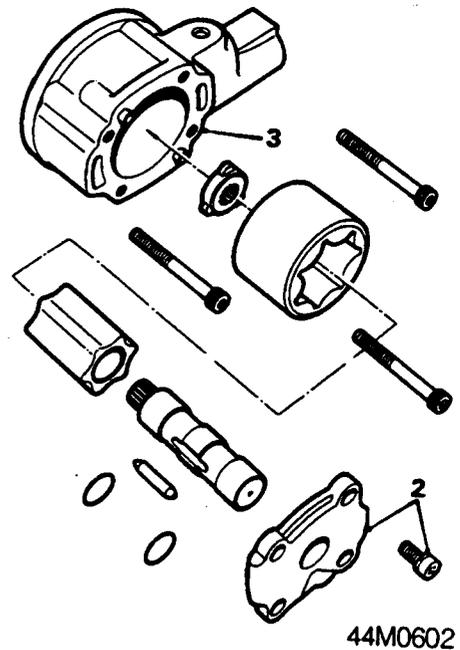
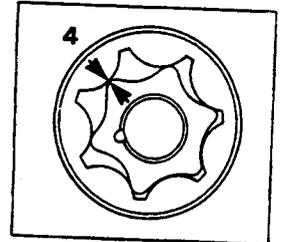

2. Remove retaining screw and detach pump cover.
3. Place a straight - edge across face of pump body and measure clearance between top face of rotors and underside of straight - edge. Clearance should not exceed 0.13mm. If clearance is excessive, this may be ioremediated by lapping joint face of pump body.
4. Measure clearance between rotor lobes when they are positioned as shown. If clearance is in excess of 0.15mm, pump assembly must be renewed.

Inspection

5. Clean and examine components for wear or damage; renew the pump assembly if necessary.

Reassemble

6. Refit pump cover and refit retaining screw.
7. Refit oil pump, see **Oil pump**.

AUTOMATIC GEARBOX

SERVO ASSEMBLY

Service Repair No. 44.34.01

Remove

1. Remove engine/automatic gearbox assembly, see **ENGINE - Repairs**.
2. Remove converter assembly, see **Converter assembly**.
3. Remove converter housing, see **Converter housing**.
4. Remove primary gear train assembly, see **Primary drive gears**.

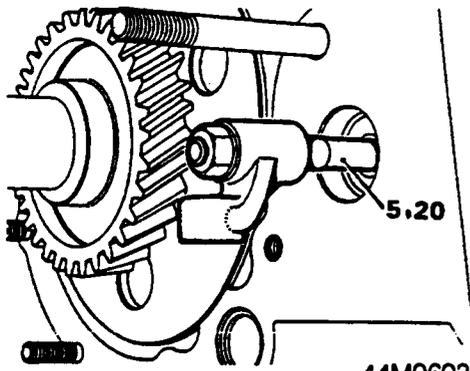

5. Unscrew and remove transverse selector rod.

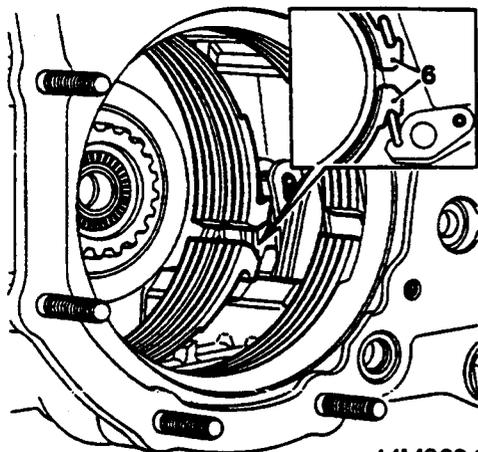

6. Unhook three brake bands from servo reaction levers and struts.
7. Remove front cover securing bolts and lift off cover complete with oil filter assembly.

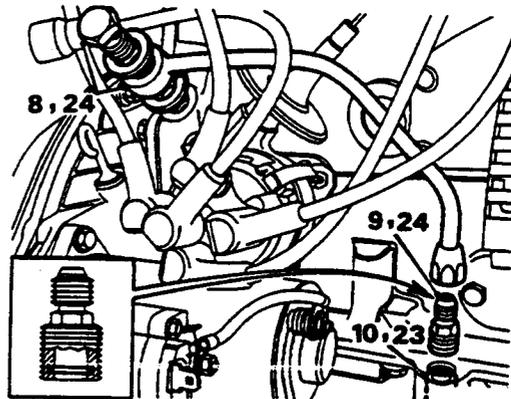

44M0605

8. Slacken engine oil pipe banjo union bolt and disconnect other end of pipe from adapter.
9. Unscrew and remove adapter.
10. Withdraw shaped copper pipe through adapter hole.

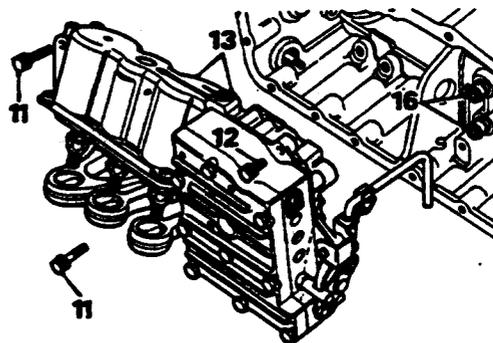

44M0606

11. Remove servo assembly securing bolts.
12. Remove three bolts securing valve block.
13. Withdraw servo unit and valve block as an assembly from gearbox casing.
14. Detach servo unit from valve block.

Refit

15. Assemble servo unit to valve block.
16. Fit valve block connections into locations in gearbox casing.
17. Refit servo/valve block assembly loosely into gearbox casing with valve block linkage located over web in casing.
18. Engage valve block linkage with spring clip drive of governor unit; see procedure in 15 to 17 in **Valve Block Assembly**



19. Refit and tighten valve block and servo unit securing bolts as follows:

Valve block bolts 14Nm
Servo bolts 23Nm

20. Screw transverse selector rod fully into valve block selector valve linkage.
21. Locate brake bands onto servo unit reaction levers and struts.
22. Refit gear train assembly.
23. Refit shaped copper pipe through adapter hole and locate it in valve block pipe chest.
24. Screw in adapter and re - connect engine oil feed pipe.
25. Use a new joint washer coated with Hylomar jointing compound (or equivalent) and refit front cover.
26. Refit converter housing, see **Converter housing**.
27. Refit converter assembly, see **Converter assembly**.
28. Refit engine/automatic gearbox assembly, see **ENGINE - Repairs**.

AUTOMATIC GEARBOX

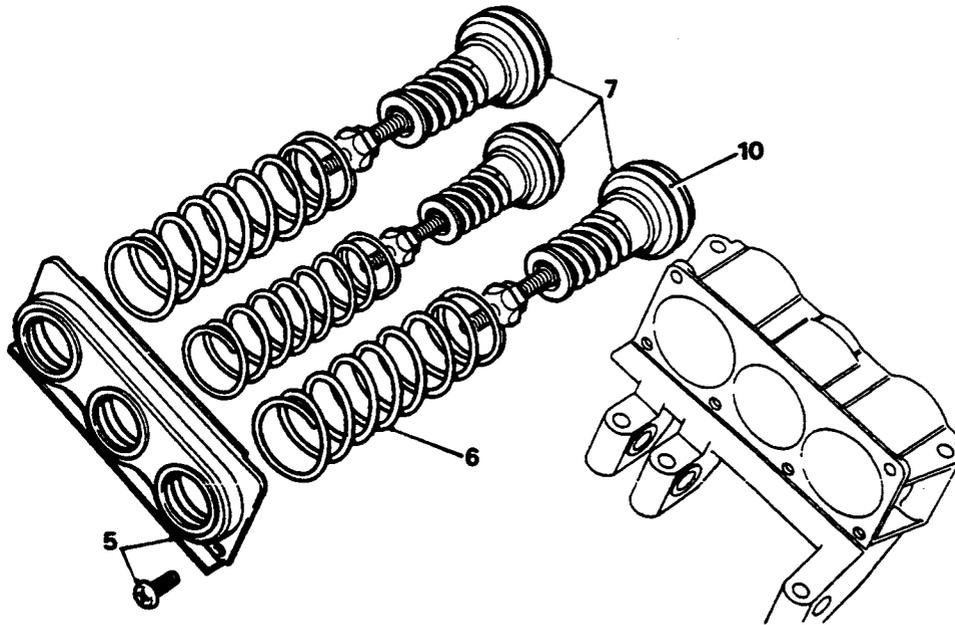

SERVO ASSEMBLY - OVERHAUL

Service Repair No. 44.34.04

Dismantle

1. Remove servo assembly, see **Servo assembly**.
2. Detach servo unit from valve block assembly.

6. Lift out piston springs.
7. Pull out servo pistons.

Inspection

8. Examine all parts for wear and check bores of servo unit for scoring; fit a new assembly if bores are damaged.
9. Renew piston seals and any other parts as required.

Reassemble

10. Lubricate new seals with oil and fit them onto their respective pistons (lips of seals facing inwards towards bores).
11. Reverse remove procedure in 2 to 7, ensuring correct assembly of reaction levers and struts (with washer correctly positioned as illustrated).
12. Reassemble servo unit to valve block.
13. Refit servo assembly, see **Servo assembly**.

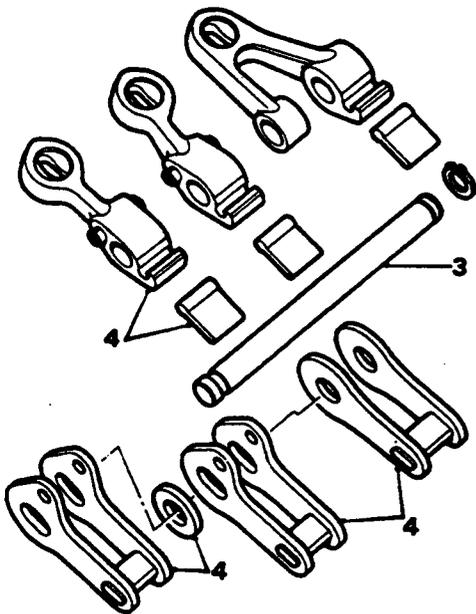

3. Remove centre shaft.
4. Lift out servo levers, reaction levers, washer, and struts.
5. Hold servo cover and remove securing screws and cover.

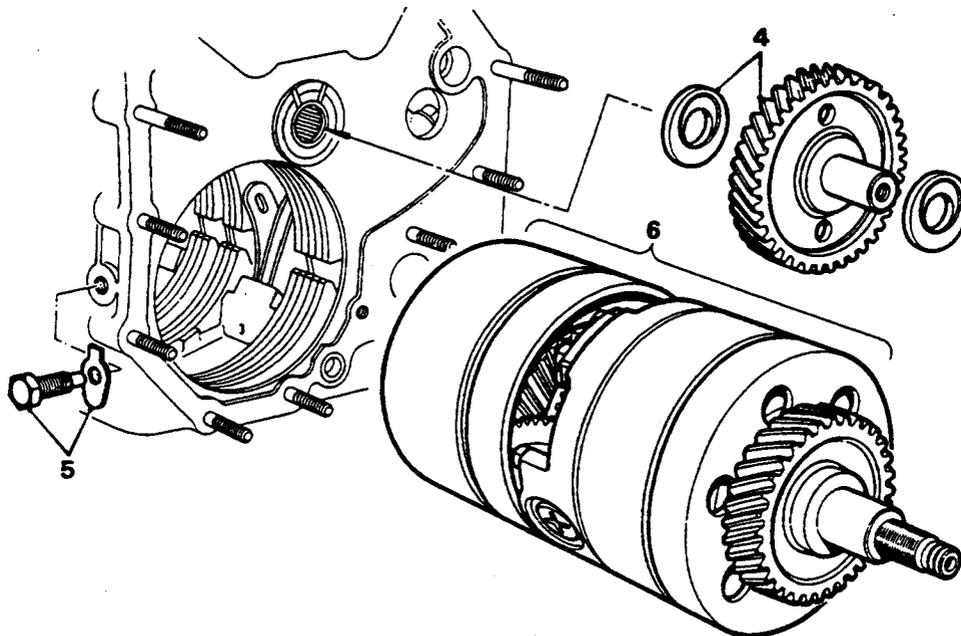
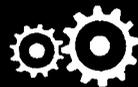

44M0609

GEAR TRAIN

Service Repair No. 44.36.01

Remove

1. Remove engine/automatic gearbox assembly, see **ENGINE - Repairs**.
2. Remove converter assembly, see **Converter assembly**.
3. Remove converter housing, see **Converter housing**.
4. Remove idler gear.
5. Knock back lock washer tab and remove dowel bolt retaining gear train assembly into gearbox casing.
6. Pull out gear train assembly complete with free - wheel reaction member and top and reverse clutch assembly.

AUTOMATIC GEARBOX

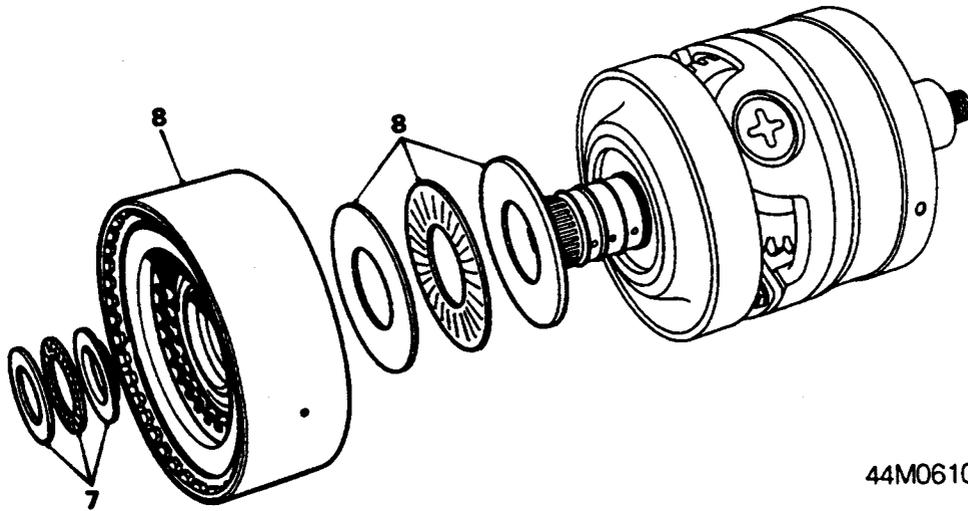

7. Remove thrust washer, needle thrust bearing and the stepped thrust washer from end of top and reverse clutch.

8. Pull top and reverse clutch off gear train, noting thrust washer (thin), needle thrust bearing, and selective thrust washer (thick), which locate onto reverse output gear shaft.

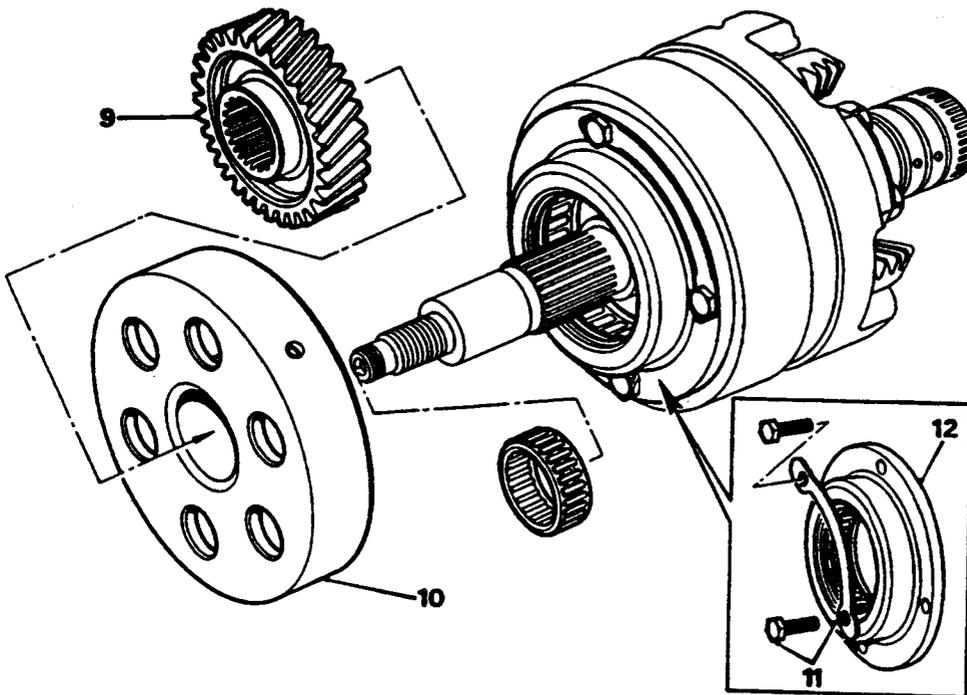

9. Pull off input gear.

10. Remove first gear free - wheel reaction member.

11. Knock back locking plate tabs and remove bolts retaining first gear free - wheel assembly to gear train.

12. Lift off first gear free - wheel housing assembly.

Refit

13. Reverse remove procedure, fitting new locking plates where applicable and lock over locking plate tabs. Torque tighten as follows:

First gear free - wheel bolts 8Nm
 Dowel bolt - gear train 38Nm

CAUTION: Apply hydraulic sealant to dowel bolt threads.

Note: If a new gear train is to be fitted, assembly will be complete with third speed reaction gear; this is equivalent to unit removed and necessary components removed from the unit as detailed in procedure 7 to 12.



14. Check that top and reverse clutch end face is level with output shaft; see procedure in 11 to 17 in **Top and Reverse Clutches**
15. Refit idler gear.
16. Refit converter housing, see **Converter housing**.
17. Refit converter assembly, see **Converter assembly**.
18. Refit engine/automatic gearbox assembly, see **ENGINE**.

SPEEDOMETER DRIVE PINION

Service Repair No. 44.38.04

Remove

1. Disconnect speedometer drive cable from pinion housing.

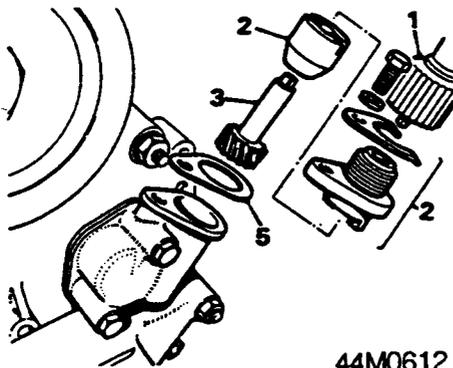

44M0612

2. Remove securing screw and withdraw spring plate, pinion bearing housing and drive pinion assembly.
3. Extract pinion from housing.

Refit

4. Refit pinion into housing.
5. Fit a new joint washer, refit pinion bearing housing and spring plate and tighten securing screw.
6. Connect up speedometer drive cable.

SPEEDOMETER DRIVE GEAR

Service Repair No. 44.38.07

Remove

1. Remove engine/automatic gearbox assembly, see **ENGINE - Repairs**.
2. Remove screws securing radiator to engine mounting adapter bracket.
3. Remove nuts retaining engine mounting adapter bracket to governor housing and detach bracket.

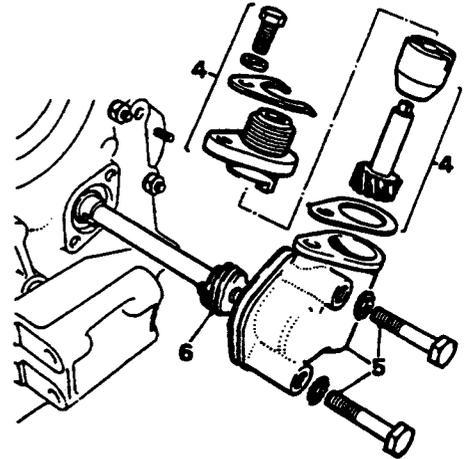

44M0613

4. Remove securing screw and withdraw spring plate, pinion bearing housing and drive pinion assembly.
5. Remove two securing screws and detach drive pinion housing from governor housing.
6. Withdraw speedometer drive gear.

Refit

7. Refit speedometer drive gear, if gear cannot easily be pushed fully into engagement with governor, follow the procedure in 8 to 10.
8. Disconnect kickdown control rod ball-joint, remove the screws and detach kickdown control assembly from gearbox casing.
9. Insert a finger through hole and raise governor end bearing into alignment and push drive gear spindle fully into engagement.
10. Refit and connect up kickdown control assembly.
11. Reverse procedure in 2 to 6.
12. Refit gearbox assembly, see **ENGINE - Repairs**.

AUTOMATIC GEARBOX

VALVE BLOCK ASSEMBLY

Service Repair No. 44.40.01

Remove

1. Remove automatic gearbox assembly, see **ENGINE**.
2. Remove the converter assembly, see **Converter assembly**.
3. Remove the converter housing, see **Converter housing**.

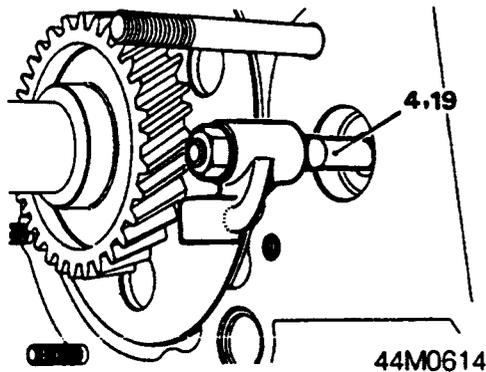

4. Unscrew and withdraw selector rod out of the gearbox.
5. Remove securing bolts and lift off the oil filter assembly.

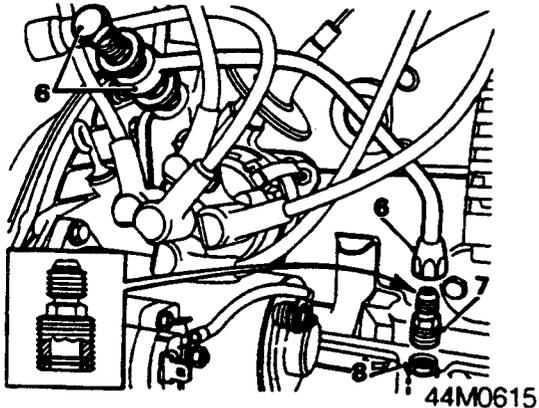

6. Slacken engine oil pipe banjo union bolt and disconnect other end of pipe from adapter.
7. Unscrew and remove adapter.
8. Withdraw shaped copper pipe through adapter hole.

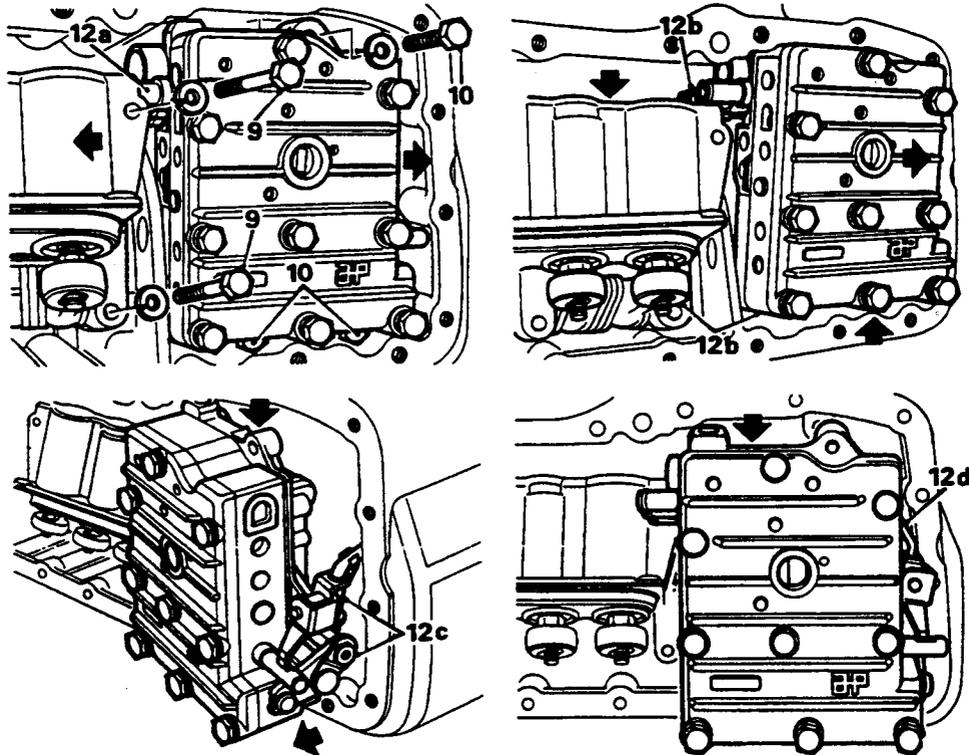

44M0616

9. Remove servo unit securing bolts.
10. Remove three bolts securing valve block to the gearbox casing.
11. Pull valve block outwards to release the governor valve operating link from spring clip drive mechanism of governor unit.
12. To remove complete valve block assembly, follow the operation sequence illustrated and detailed below in 'a' to 'd'. 'Arrows' indicate direction of movement of valve block and servo units:
 - a Move valve block away from servo until three interconnecting pipes are release from servo.
 - b Pull servo unit downwards and move valve block upwards and sideways to get connecting pipes over top of servo unit.
 - c Manoeuvre valve block so that selector valve and governor valve linkage is clear of casing.
 - d Pull linkage end of valve block outwards, lift the governor rod link over web in gearbox casing and remove valve block assembly.
13. Before refitting, check 'O' rings on interconnecting pipes and valve block to casing connections. Fit new 'O' rings as required and refit two short connections into their locations in gearbox casing.

Refit

14. Refit valve block, noting following:
 - a Locate governor link over web in transmission before attempting to position valve block and engage pipes.
 - b Reverse sequence 'a' to 'd' in procedure 12 to get the valve block in position and interconnecting pipes engaged in servo unit.
 - c Finally engage governor valve link with spring clip drive of governor; see procedure in 15 to 17.

AUTOMATIC GEARBOX

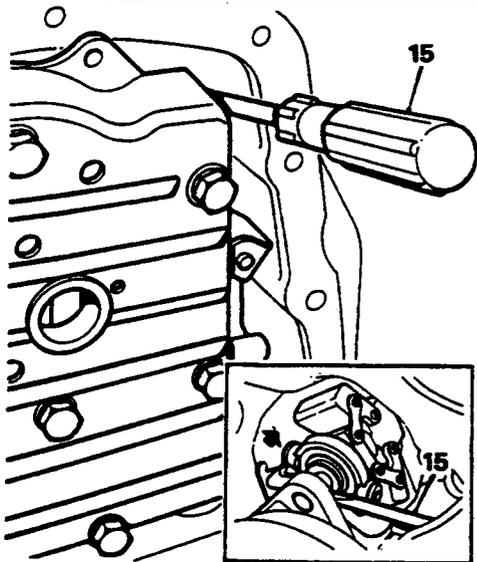

44M0617

15. Using a long thin screwdriver, insert it between governor carrier and bearing to provide required angle of spring clip drive with valve block link.

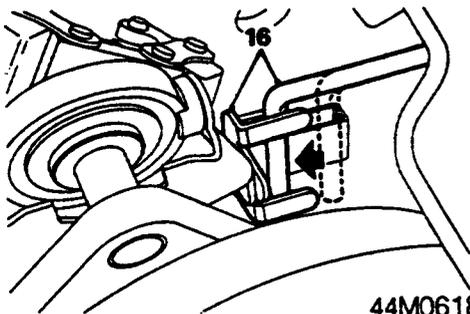

44M0618

16. Hold link with a pair of suitable pliers and push the link fully into engagement with spring clip drive (as illustrated). Pull out screwdriver.
17. Push valve block inwards to engage it with pipe connections in gearbox casing.
18. Refit and tighten valve block and servo unit securing bolts as follows:

Valve block bolts	14Nm
Servo bolts	23Nm

19. Screw transverse selector rod fully into valve block selector valve linkage.
20. Remainder is a reversal of remove procedure.
21. Refit converter housing, see **Converter housing**.
22. Refit converter assembly, see **Converter assembly**.
23. Refit engine/automatic gearbox assembly, see **ENGINE**.

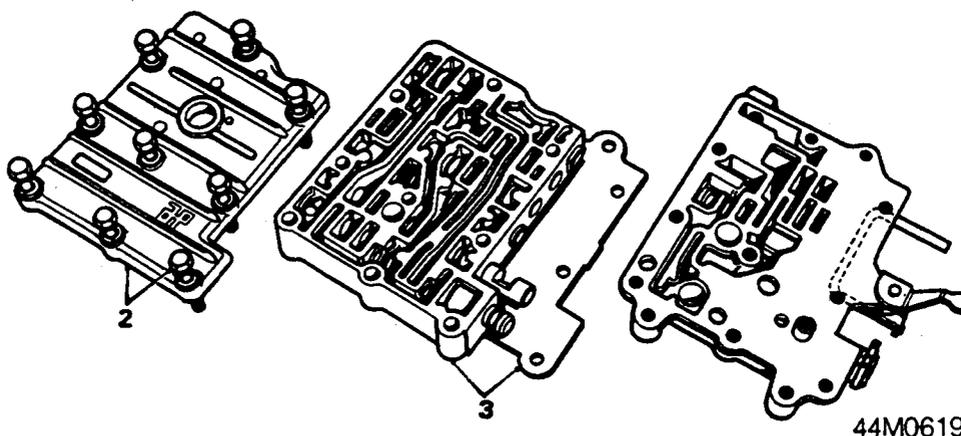
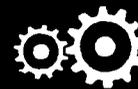

VALVE BLOCK ASSEMBLY - OVERHAUL

Service Repair No. 44.40.04

Dismantle

1. Remove valve block assembly, see Valve block assembly.

Note: Before dismantling valve block it must be

remembered that valves are selected for each bore.

It is important to reassemble each valve into its original bore and position. Absolute cleanliness is essential, therefore it is advisable to dismantle unit on a clean sheet of paper.

2. Remove retaining bolts and detach lid.
3. Remove valve chest and separator plate from pipe chest, not small flap valve fitted between valve chest and separator plate.

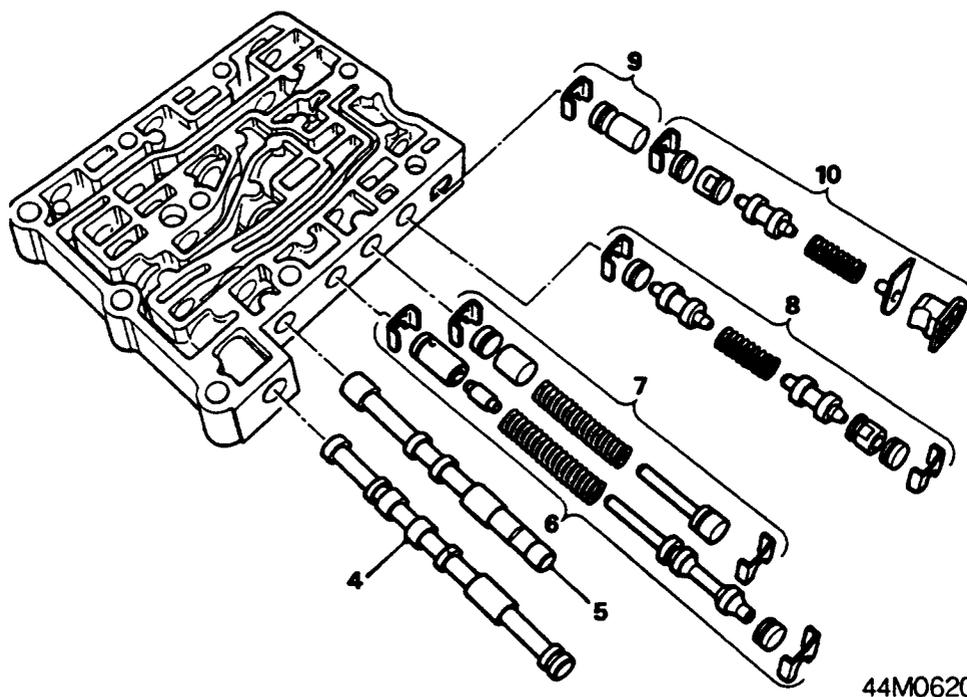

4. Remove selector valve.
5. Remove governor valve.
6. Remove 'C' clips and plugs and withdraw regulator valve components.
7. Remove 'C' clips and plug and withdraw engagement control valve components.
8. Remove 'C' clips and plugs and withdraw second and fourth gear valves and components.
9. Remove end 'C' clip and extract plug and one-way dump valve.

10. Remove centre 'C' clip, plastic end plug and spring retainer; extract third gear valve components.

AUTOMATIC GEARBOX

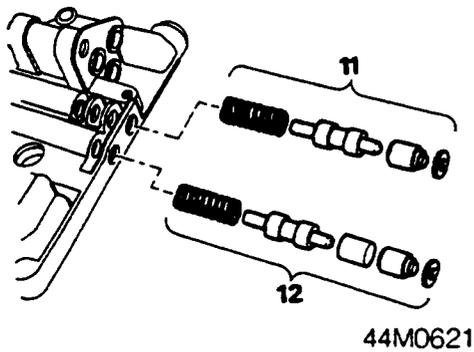

11. *Pipe chest:* Third gear and reverse gear shuttle valves are located in back of pipe chest. Depress abutment plug and remove retaining washer, third gear shuttle valve and spring.
12. Repeat procedure in 11 to remove reverse gear shuttle valve, except that an engagement piston is also fitted in the same bore.

Inspection

13. Clean all parts thoroughly in clean fuel (petrol) or paraffin (kerosene) and dry off using an air pressure line.
14. Check for burrs on valves and bores, check that all valves move freely in their respective bores. Immerse all components in clean engine oil before reassembling.

Reassemble

15. Reverse dismantling procedure in 2 to 12 with the components fitted in order illustrated.

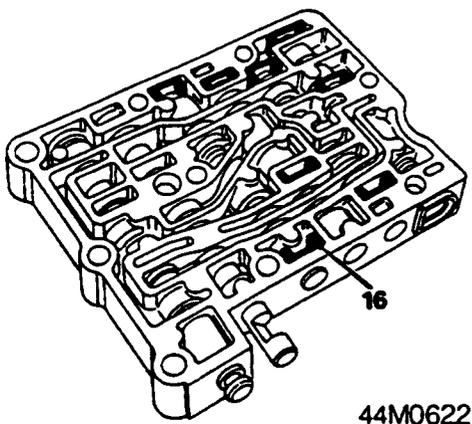

16. Check that all 'C' clips have been correctly located and fitted as shown in illustration.

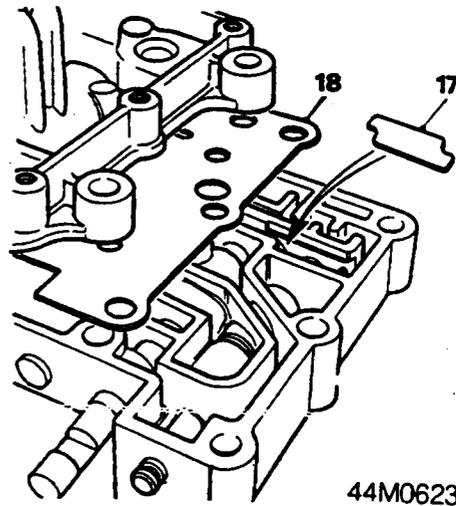

17. When refitting main sections together, start with valve chest - front face downwards and insert flap valve into its location (arrowed).
18. Refit separator plate and pipe chest to valve chest and locate governor operating lever with governor valve, and selector rod link into grooved end of selector valve.
19. Hold complete assembly together, turn it over, and refit lid.
20. Tighten lid retaining bolts as follows:

5/16 in UNF bolts	25Nm.
3/8 in UNF bolts	40Nm.
21. Refit valve block assembly, see Valve block assembly.

DRIVE SHAFTS

CONTENTS

REPAIRS

Page

DRIVE SHAFT ASSEMBLY	1
DRIVE SHAFT BOOT	2
CONSTANT VELOCITY JOINT	2
DRIVE SHAFT INBOARD JOINT	3
DRIVE SHAFT INBOARD JOINT BOOT	3



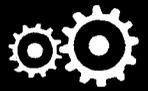

DRIVE SHAFT ASSEMBLY

Service Repair No. 47.10.01

Remove

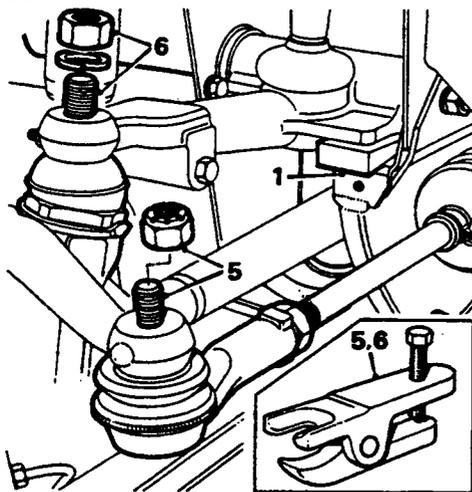

47M0103

1. Remove one screw retaining suspension upper arm rebound rubber and place a solid wedge of same thickness in its place.
2. Slacken road wheel nuts.
3. Remove split pin retaining drive shaft nut and slacken nut.
4. Jack up vehicle, place stands under sub - frame side members and remove road wheel.
5. Remove nut retaining steering tie - rod ball joint and release joint from steering lever, using **18G 1063**.
6. Remove upper swivel hub ball pin retaining nut and spring washer. Release joint, using **18G 1063**, and refit retaining nut loosely. Remove disc shield.

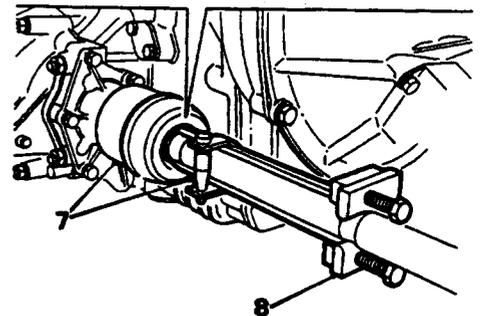
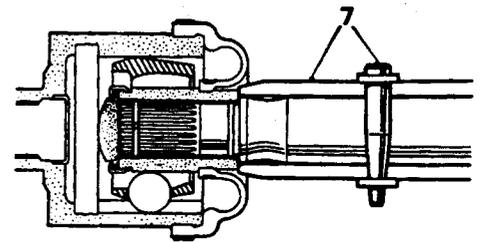

47M0104

7. Assemble Service tool **18G 1243** to drive shaft with tool hard against inboard joint before inserting taper pin.
 8. Insert 'U' shaped part of tool into groove on shaft, tighten two bolts evenly until drive shaft is released from inboard joint. Remove tool.
 9. Remove nut and disconnect swivel hub ball pin from suspension upper arm.
- WARNING: Take care not to stretch brake hose.**
10. Retain position of inboard joint boot and at same time withdraw shaft out of joint.
 11. Push shaft inwards and over top of final drive assembly; remove drive - shaft retaining nut and tap shaft out of driving flange.
 12. Withdraw drive shaft out of swivel hub and then outwards away from vehicle.
- Do not carry out further dismantling if component is removed for access only**

DRIVE SHAFTS

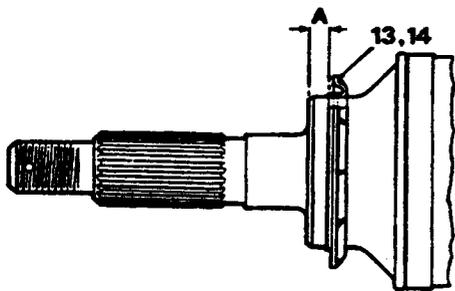

47M0105

13. Remove hub bearing water shield.

Refit

14. Reverse procedure in 1 to 13, noting:
 - a Position hub bearing water shield onto drive shaft as shown:

'A' = 6 mm approximately

- b Push drive shaft smartly into inboard joint to lock shaft into joint.
- c Tighten swivel hub ball pin retaining nut to 52Nm.
- d Tighten drive shaft nut to 262Nm, if necessary, tighten further to align split pin hole.

DRIVE SHAFT BOOT

Service Repair No. 47.10.03

Remove

1. Remove drive shaft assembly.
2. Cut through rings securing boot.
3. Withdraw boot off drive shaft.

Refit

4. Thoroughly clean joint assembly.
5. Position new boot on drive shaft.
6. Pack bearing with 30 cm³ of Duckhams Bentone Grease Q5795.

CAUTION: Do not overfill joint, allowance must be made for grease remaining in joint.

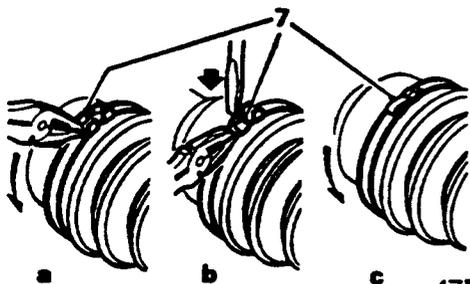

47M0106

7. Use 18G 1099 to secure boot retaining clips, noting following:
 - a Clip must be fitted with fold in clip facing forward rotation of drive shaft.
 - b Pull free end of clip tightly between front locking tabs of clip and close front locking tabs onto clip.

- c Fold clip back over front locking tabs and close rear locking tabs to secure clip end.
8. Alternative method: Secure boot to joint using 1.5mm soft iron wire, wind wire twice around boot, twist ends firmly together several turns and bend ends away from direction of rotation.
 9. Refit drive shaft assembly.

CONSTANT VELOCITY JOINT

Service Repair No. 47.10.04

Remove

1. Remove drive shaft assembly.

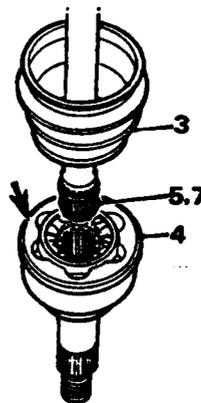

47M0107

2. Cut ring securing boot to outer member of constant velocity joint.
3. Fold back boot to expose joint.
4. Hold drive shaft vertical, use a soft faced mallet and strike edge of constant velocity joint to release it from drive shaft.
5. Remove drive shaft spring ring.

Refit

6. Thoroughly clean constant velocity joint assembly.
7. Fit a new spring ring to drive shaft, compress ring on shaft to assist entry of shaft into inner member; use a soft faced mallet to drift drive shaft into inner member.
8. Pack bearing with 30 cm³ of Duckhams Bentone Grease Q5795.

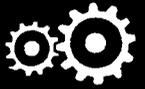

Refit

7. Reverse procedure in 1 to 6, noting following:
 - a Fit a new inboard joint spring clip.
 - b Fit a new oil flinger if it has been damaged.
 - c Tighten swivel hub ball pin retaining nuts to 52Nm.

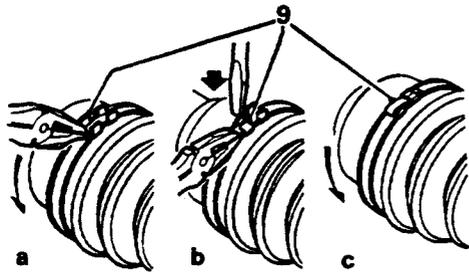

47M0112

9. Use **18G 1099** to secure boot retaining clip, noting following:
 - a Clip must be fitted with fold in clip facing forward rotation of drive shaft.
 - b Pull free end of clip tightly between front locking tabs of clip and close front locking tabs onto clip.
 - c Fold clip back over front locking tabs and close rear locking tabs to secure clip end.
10. Refit drive shaft assembly.

DRIVE SHAFT INBOARD JOINT

Service Repair No. 47.10.14

Remove

1. Withdraw drive shaft from inboard joint, but do not unlock or slacken drive shaft nut, see **Drive Shaft Assembly**
2. Withdraw drive shaft out of inboard joint, position shaft over top of final drive housing.

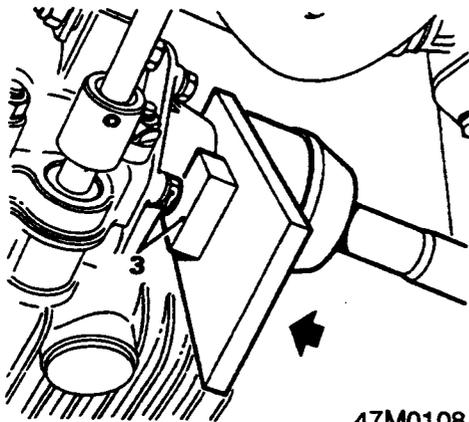

47M0108

3. Use **18G 1240** to release inboard joint from final drive; insert tool between joint and final drive end cover and strike flat face of tool inwards towards final drive, this will release joint.
4. Remove inboard joint.
5. Detach oil flinger from inboard joint.
6. Remove and discard inboard joint spring clip.

DRIVE SHAFTS

DRIVE SHAFT INBOARD JOINT BOOT

Service Repair No. 47.10.16

Remove

1. Remove drive shaft inboard joint.
2. Remove and discard two retaining rings and rubber boot from inboard joint.
3. Withdraw joint inner member and ball cage assembly from joint outer member.

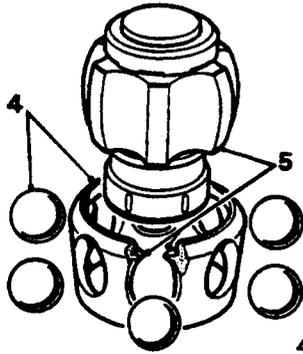

47M0109

4. Insert a screwdriver between joint inner member and each ball in turn and push balls out of ball cage.
5. Rotate ball cage until grooves inside cage coincide with lands on joint inner member and withdraw cage from inner member.

Refit

6. Clean all components in a cleaning solvent.
7. Assemble joint inner member, ball cage and balls, reversing procedure in 4 and 5 and ensuring that long tapered end of ball cage faces towards drive shaft end of joint inner member.
8. Fit joint inner member assembly into joint outer member.

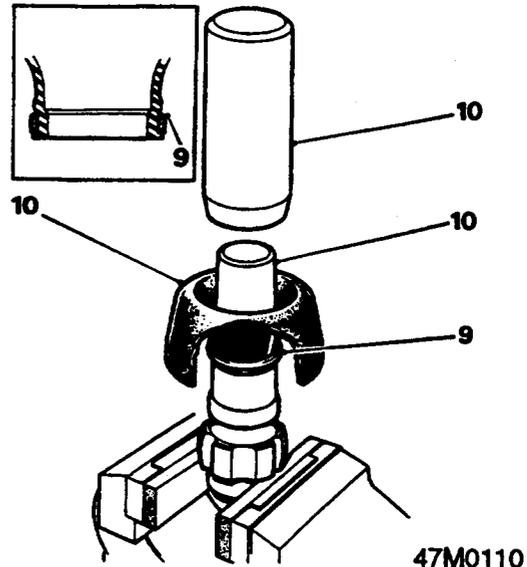

47M0110

9. Fit a new retaining ring to inner neck of a new rubber boot, with chamfered end of ring towards inside of boot.
10. Fold back boot and, using 18G 1251, mandrel of which must be lubricated with a liquid detergent or rubber lubricant, fit boot to joint inner member.
11. Withdraw joint inner member and boot assembly from joint outer member and remove all traces of detergent.
12. Pack joint inner and outer members with 50 cm³ of Shell S7274 Tivella 'A' grease and fit inner member into outer member.

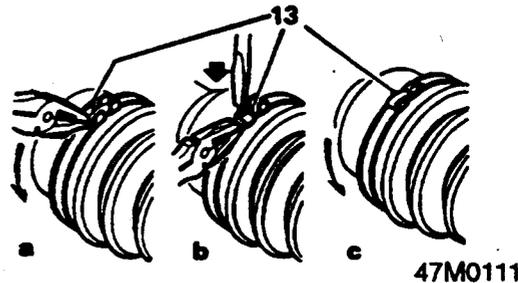

47M0111

13. Secure rubber boot to joint outer member, using a service clip and tool 18G 1099. Clip must be fitted with fold in clip facing towards direction of joint forward rotation.
 - a. Pull free end of clip tightly between clip front locking tabs.
 - b. Close front locking tabs onto clip
 - c. Fold clip back over front locking tabs and close rear locking tabs to secure clip end.
14. Refit drive shaft inboard joint.

DIFFERENTIAL

CONTENTS

DESCRIPTION	Page
DIFFERENTIAL AND FINAL DRIVE DESCRIPTION	2

REPAIRS	Page
DIFFERENTIAL, FINAL DRIVE GEAR AND PINION - OVERHAUL	1
DIFFERENTIAL CAGE BEARINGS	3
DIFFERENTIAL END COVER OIL SEAL	4



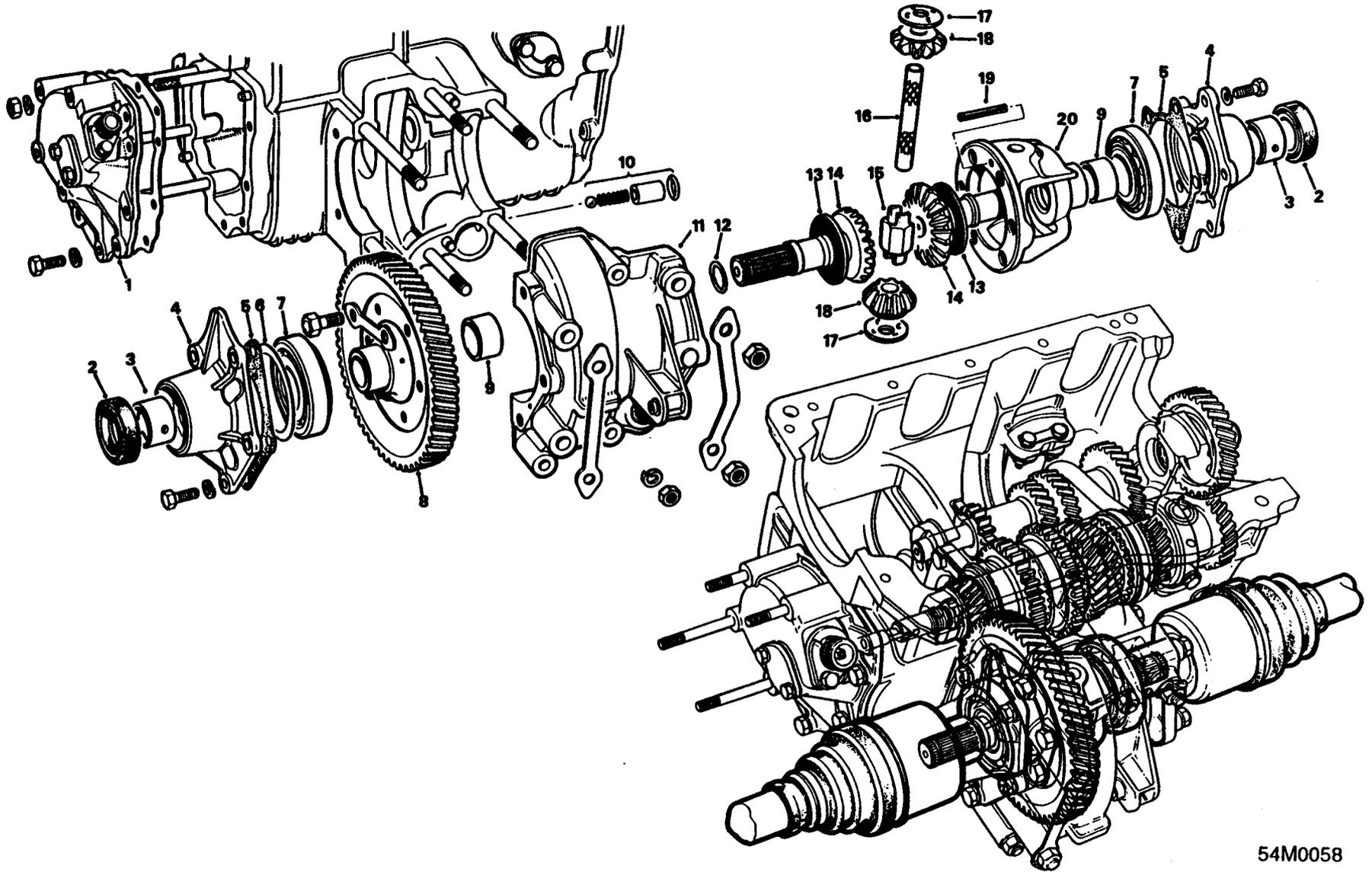

54M0058

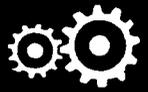
**Differential and final drive components**

1. Speedometer drive housing
2. Oil seal
3. Bush – drive shaft
4. Differential end cover
5. Gasket
6. Shim
7. Bearing
8. Final drive gear
9. Bush – drive gear
10. Detent ball, spring, ball and 'O' ring
11. Differential housing
12. Spring ring
13. Thrust washer
14. Differential gear
15. Differential thrust block
16. Differential pinion pin
17. Thrust washer
18. Differential pinion
19. Roll pin
20. Differential cage



DIFFERENTIAL, FINAL DRIVE GEAR AND PINION - OVERHAUL

Service Repair No. 54.10.08

Dismantle

- 1a Remove engine/gearbox assembly, see **ENGINE**.
- b Remove engine/automatic gearbox assembly, see **ENGINE**.

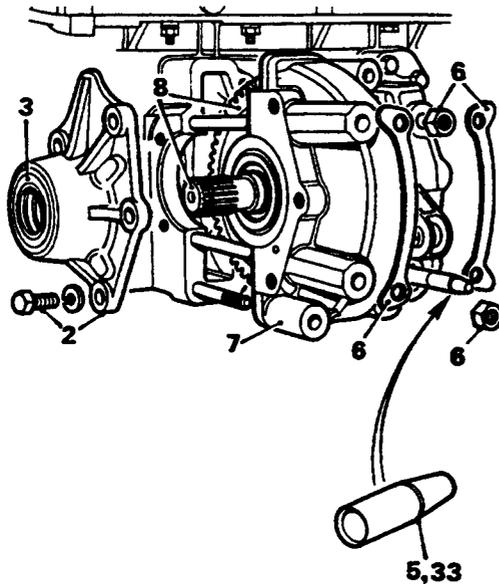

54M0048

2. Remove securing screws and detach differential end covers: note adjustment shims fitted beneath cover on final drive gear side.
3. Remove oil seals from end covers.
4. Extract selector shaft detent spring, sleeve and ball.
5. Locate 18G 1236 oil seal protector sleeve over selector shaft.
6. Knock back locking plate tabs from differential housing securing nuts, remove nuts and locking plates.
7. Pull off differential housing; discard oil seal and remove nylon bush (if fitted) noting type of bush fitted, i.e with or without an 'O' ring.
8. Remove differential unit.

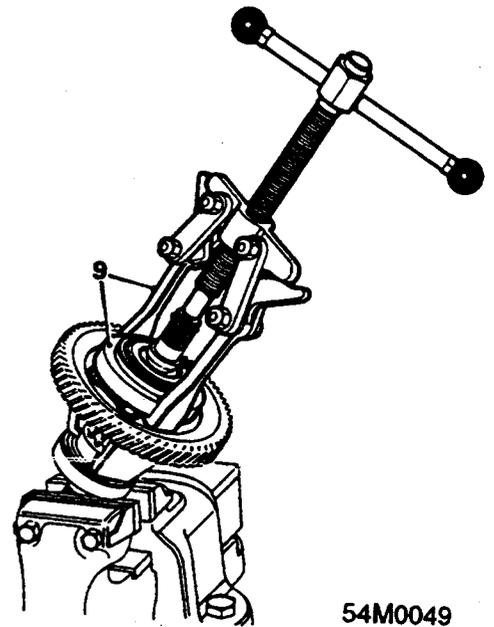

54M0049

9. Use 18G 2 and 18G 2G to pull bearings off differential cage. Bearings are marked 'THRUST' on their outer face.
10. Mark final drive gear and differential cage for assembly purposes.
11. Tap back locking plate tabs and remove final drive gear securing bolts.
12. Remove final drive gear complete with differential gear which is located in it.
13. Pull differential gear out of final drive gear.
14. Drift out roll pin retaining pinion pin from differential cage.
15. Drift out pinion pin from differential cage.
16. Remove differential thrust block.
17. Remove pinions and thrust washers.
18. Withdraw other differential gear and washer.
19. Remove speedometer drive gear pinion, see **MANUAL GEARBOX**.
20. Remove speedometer drive housing, see **MANUAL GEARBOX**.

DIFFERENTIAL

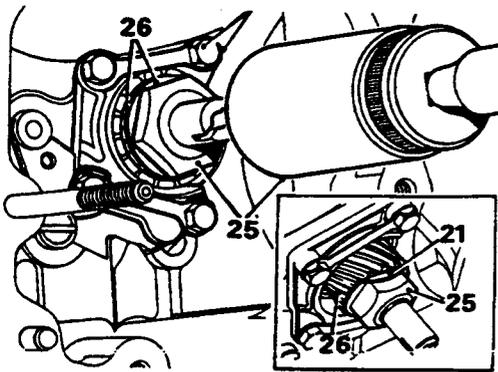

54M0050

21. Knock back lock washer tab from final drive pinion nut.
22. Rotate selector shaft anti-clockwise to disengage the operating stub and interlock spool from bellcrank levers.
23. Lever first/second speed selector fork towards centre web of gearbox casing to engage first gear.
24. Use a screwdriver and carefully drift centre bellcrank lever inwards to select fourth gear; gear train is now locked in two gears.
25. Use 18G 587 to remove final drive pinion securing nut.
26. Withdraw final drive pinion and lock washer.

Inspect

27. Clean and examine all components for wear or damage.

Fit new pinion and differential gears as a complete set if any are worn and reassemble with new thrust washers. If it is necessary to renew the final drive gear and/or pinion they must be renewed as a pair.

Reassemble

28. Reverse procedure in 4 to 26, noting following:

- a Clean off all traces of old gaskets and check all joint faces are free from burrs; fit new joint washers.
- b Fit new locking washers and plates.
- c Tighten the following to correct torque and tap over locking plate tabs:

Final drive gear bolts	80Nm
Pinion nut	200Nm
Differential housing nuts	35Nm
End cover bolts	25Nm

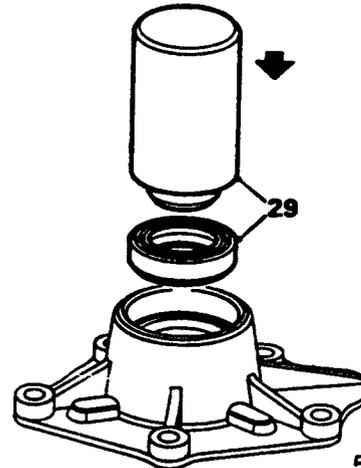

54M0051

29. Fit new oil seals into differential end covers, using 18G 1238.
30. Move selector bellcrank levers into neutral position and rotate interlock spool and selector shaft stub into engagement with bellcrank levers.

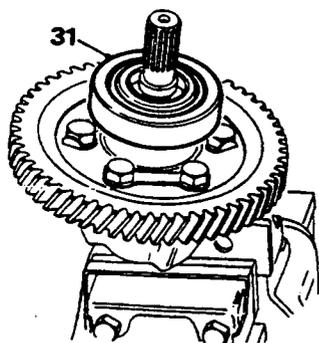
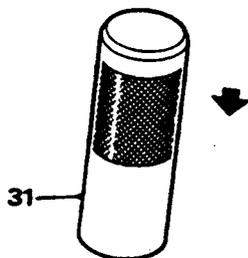
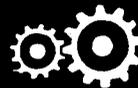

54M0052

31. Use 18G 578 to drift bearings onto differential cage with their 'THRUST' markings facing outwards.
32. Refit differential unit into gearbox casing with a slight bias towards flywheel end engine.
33. Fit nylon bush and 'O' ring into differential housing. Smear bush and 'O' ring with lithium based grease prior to fitting.
34. Fit a new selector shaft oil seal; smear seal with clean engine oil prior to fitting.
35. After fitting seal, check nylon bush does not protrude beyond face of differential housing.
36. Fit oil seal protector sleeve 18G 1236 over selector shaft, then fit differential and housing, taking care not to disturb nylon bush.

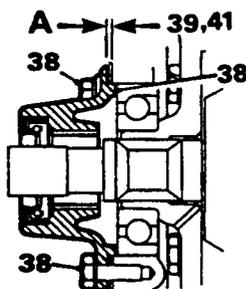

54M0053

37. Fit new locking plates and screw on all securing nuts sufficiently to hold differential unit firmly and yet allow unit to be displaced by fitting of end cover on flywheel.
38. Refit end cover (flywheel end) together with a new gasket; ensure oil holes in end cover are aligned with those on differential housing.

39. Tighten screws evenly in diagonal sequence to ensure maximum contact between inner face of cover and bearing outer race.

Note: As screws are tightened differential unit will be displaced away from flywheel/converter end of engine to allow bearing pre-load adjustment to be carried out.

Bearing pre-load adjustment

40. Fit other end cover without its gaskets shims and tighten securing screws in diagonal sequence just sufficiently for cover register to nip bearing outer race; overtightening will distort cover flange.
41. Take feeler gauge measurements in several positions between the cover flange and gearbox differential housing: variations in measurement will indicate that cover securing screws have not been tightened evenly: adjust tension on screws accordingly until same reading is obtained in all positions.

Note: If no gap exists between flange and housing, remove cover and add a known thickness of shims between cover and bearing to produce a clearance. Thickness of shims fitted must be included in calculation of pre-load shim requirement.

42. Clearance 'A' between cover flange and housing is taken up by new gaskets which has a compressed thickness of 0.18mm, plus necessary number of shims to give pre-load required:

Example:

Gasket (compressed thickness)	0.18mm
Measure clearance 'A'	0.13mm
Therefore endfloat (without shims) =	0.05mm
Mean pre-load required	0.10mm
Therefore thickness of shims required =	0.15mm

DATA

Bearing pre-load	0.1mm
Differential bearing shim sizes available	0.05mm 0.15mm 0.25mm 0.50mm

43. Smear adjustment shims with grease and fit them to thrust face of bearing. Fit new gasket, refit and tighten end cover securing screws to 25Nm.
- 44a Refit engine/gearbox assembly, see ENGINE.

DIFFERENTIAL

- b Refit engine/automatic gearbox assembly, see **ENGINE**.

Refit

DIFFERENTIAL CAGE BEARINGS

Service Repair No. 54.10.12

Remove

- 1a Remove engine/gearbox assembly, see **ENGINE**.
- b Remove engine/automatic gearbox assembly, see **ENGINE**.
- 2. Remove differential assembly from power unit.

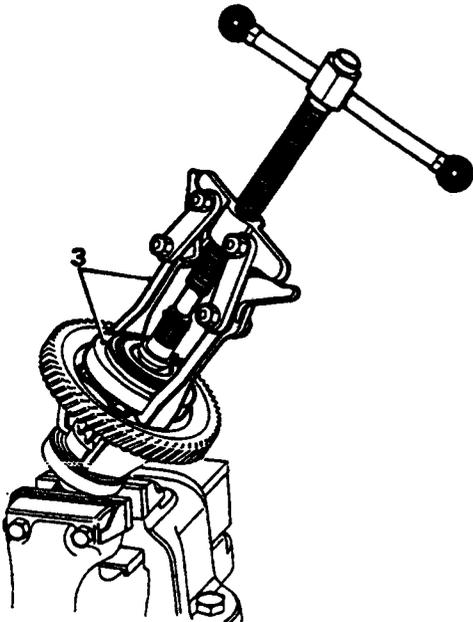

54M0054

- 3. Use 18G 2 and 18G 2G to pull bearings off the differential cage. Bearings are marked 'THRUST' on their outer face.

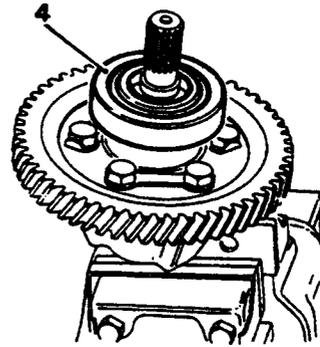
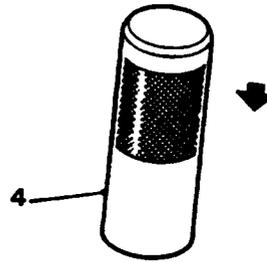

54M0055

- 4. Drift bearings onto differential cage using 18G 578, with 'THRUST' markings facing outwards.
- 5. Refit differential unit into gearbox casing.
- 6a Refit engine/gearbox assembly, see **ENGINE**.
- b Refit engine/automatic gearbox assembly, see **ENGINE**.

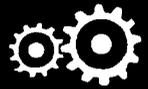

DIFFERENTIAL END COVER OIL SEAL

Refit

Service Repair No. 54.10.17

Remove

1. Raise front of car and place stands beneath body front side members.

WARNING: Support on safety stands.

2. Drain engine/gearbox oil.
3. Remove road wheel(s).

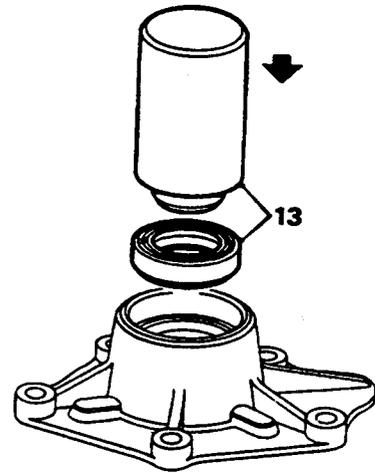
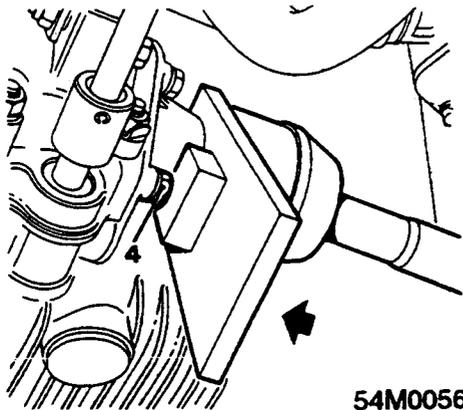

13. Use 18G 1238 to drift new oil seal into end cover.
14. Fit a new gasket to end cover.
15. Reverse procedure in 1 to 10, noting following:
Tighten end cover retaining screws to 25Nm.

4. Use 18G 1240 to release required drive shaft inboard joint from differential.
5. Release and disconnect suspension lower arm from swivel hub, using 18G 1063.
6. Release and disconnect suspension upper arm from swivel hub, using 18G 1063.
7. Support swivel hub assembly to avoid stretching hydraulic brake hose.
8. Withdraw drive shaft assembly complete with inboard joint out of differential sufficiently to enable differential end cover to be removed.
9. Locate upper swivel pin into suspension arm and screw securing nut on loosely to hold swivel hub and avoid stretching brake hose.
10. Remove differential end cover as follows:
 - a LH side: Remove securing screws and withdraw end cover complete with its gasket, note that adjustment shims are fitted against face of differential cage bearing.
 - b RH side: Remove securing screws and withdraw end cover complete with its gasket; note that cover is under tension from gearbox selector shaft detent spring which will be partly exposed.
11. Remove old seal from end cover.
12. Clean off all traces of old gasket from mating faces of cover and housing.

STEERING

CONTENTS

Description and Operation	Page
Rack and pinion and steering column components	3

Repairs	Page
Steering wheel	1
Steering column nacelle.	1
Steering column top bush	2
Steering column	3
Steering column overhaul	3
Track rod end	4
Steering rack gaiter	5
Steering lever	5
Steering rack and pinion	6
Steering rack and pinion overhaul	7



STEERING



57M0260



RACK AND PINION AND STEERING COLUMN COMPONENTS

1. Track rod end
2. Locknut
3. Clip
4. Gaiter
5. Clip
6. Ball housing
7. Track rod
8. Ball seat
9. Locknut and grooved pin
10. Thrust spring
11. Rack
12. Rack housing
13. Plug - rack centring
14. Rack bush
15. Retaining screw
16. Cover plate - damper*
17. Shims - selective*
18. Thrust spring
19. 'O' ring
20. Rack support yoke
21. End cover - pinion
22. Joint washer
23. Shim - standard
24. Shims - selective
25. Pinion bearings
26. Pinion
27. Pinion to body seal
28. Sealing washer - pinion to floor
29. Ignition/starter switch and steering lock
30. Lower bush
31. Steering column - outer
32. Upper bush
33. Steering column - inner
34. Steering wheel
35. Lock washer
36. Nut
37. Hub cover
38. Retaining clip
39. Column bracket and shear bolt
40. Clamp plate - column to parcel shelf
41. 'U' bolt
42. Anti-friction strip - 'U' bolt
43. Nacelle - LH
44. Nacelle - RH
45. Spire nut

* Up to VIN 068303 - RHD and VIN 067688 - LHD



STEERING WHEEL

Service Repair No. 57.60.01

Remove

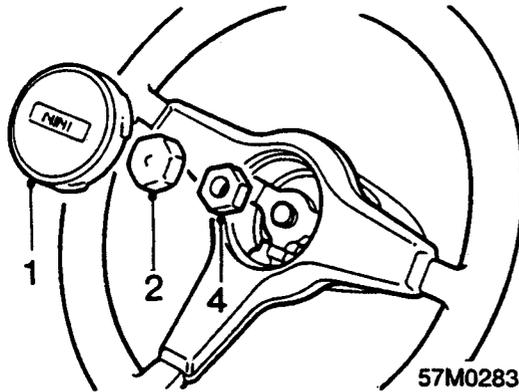

1. Remove cover from centre of steering wheel.
2. Remove cover from steering wheel nut.
3. Align wheels straight ahead and suitably mark fitted position of steering wheel to inner column.
4. Restrain steering wheel and slacken the self-locking nut securing the wheel to the column.
5. Loosen steering wheel from column splines by applying impact to the rear of the steering wheel directed as close to the steering wheel centre as possible.

CAUTION: Do not fully remove nut until the steering wheel is loosened from the column.

6. Remove and discard self-locking nut.
7. Remove steering wheel.

Refit

1. Fit steering wheel ensuring that reference marks are aligned.

CAUTION: Ensure indicator cancelling ring is aligned with steering wheel.

2. Fit new self-locking nut and tighten 33 Nm.
3. Fit cover to centre of steering wheel.

STEERING COLUMN NACELLE

Service Repair No. 57.40.29

Remove

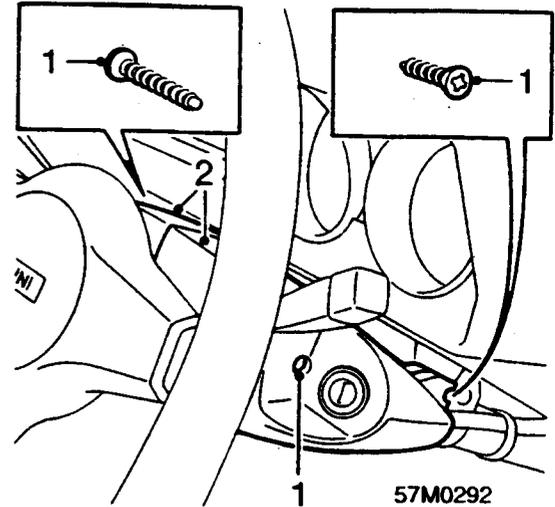

1. Remove 3 screws securing 2 halves of steering column nacelle to column.
2. Remove steering column nacelle.

Refit

1. Align 2 halves of steering column nacelle to column and secure with screws

STEERING

STEERING COLUMN TOP BUSH

Service Repair No. 57.40.09

Remove

1. Disconnect battery earth lead.
2. Remove steering wheel, see **Steering wheel**.

Remove steering column nacelle, see **Steering column nacelle**.

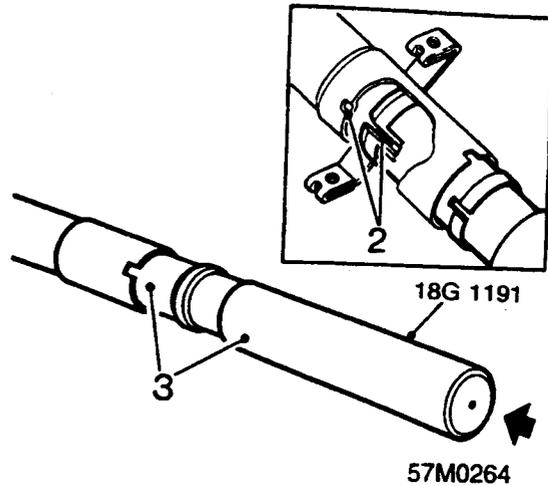
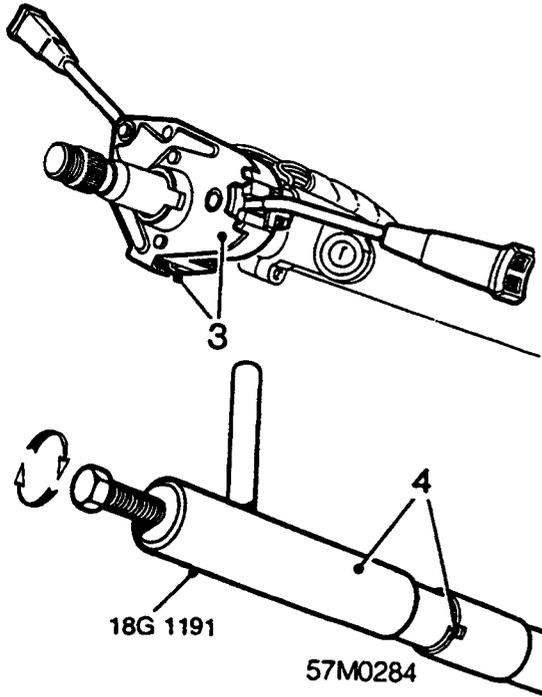

2. Position top bush, chamfered end leading into outer column ensuring that shouldered slot in bush is located in detent in outer column.
3. Using tool 18G 1191, drift bush into column.
4. Position column switch to column, tighten securing screw.
5. Fit steering column nacelle, see **Steering column nacelle**.
6. Fit steering wheel, see **Steering wheel**.
7. Connect battery earth lead.

3. Slacken screw securing column switch assembly to steering column, withdraw switch assembly.
4. Using tool 18G 1191, remove and discard top bush from column.

Refit

1. Lubricate inside surface of replacement top bush with lithium grease, see **INFORMATION - CAPACITIES, FLUIDS AND LUBRICANTS**.



STEERING COLUMN

Service Repair No. 57.40.01

Remove

1. Raise front of vehicle.

WARNING: Support on safety stands.

2. Remove steering column nacelle, see **Steering column nacelle**.

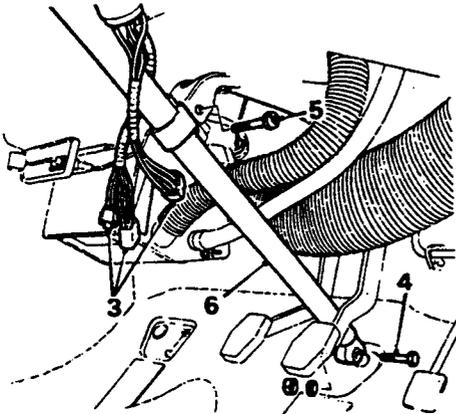

57M0265

3. Disconnect column switch and ignition switch multiplugs.
4. Remove inner column to pinion pinch bolt.
5. Cut a slot in the head of steering column shear bolt, remove and discard bolt.
6. Set road wheels in straight ahead position, release inner column from pinion; remove steering column assembly.

Refit

1. Pull back floor covering in passenger footwell and remove grommet from floor.
2. Using an Allen key, remove plug from steering rack.
3. Using assistance, move road wheels until a 6 mm diameter rod can be inserted into the centralising hole in the steering rack.
4. Position steering column assembly ensuring steering wheel spokes are in straight ahead position.

5. Fit but do not tighten steering column to mounting bracket shear bolt.

CAUTION: Do not force steering column sideways to align steering column to mounting bracket. Slacken screws securing mounting bracket to fascia rail and move bracket to obtain correct alignment. Tighten screws on completion.

6. Fit inner column to pinion pinch bolt and tighten to 16 Nm.
7. Position outer column to give 2 mm clearance between steering wheel hub and boss of column switch.
8. Tighten steering column to mounting bracket shear bolt until head shears off.

9. Connect starter switch and column switch multiplugs.
10. Remove 6 mm rod from steering rack, fit and tighten plug.
11. Fit grommet to floor and reposition floor covering.
12. Fit steering column nacelle, see **Steering column nacelle**.
13. Remove stand(s) and lower vehicle.

STEERING COLUMN OVERHAUL

Service Repair No. 57.40.10

Dismantle

1. Remove steering wheel, see **Steering wheel**.
2. Remove steering column, see **Steering column**.
3. Slacken screw securing column switch assembly to column and remove.
4. Centre punch the top of then drill out shear bolts securing steering column lock and saddle to column. Remove steering column lock.

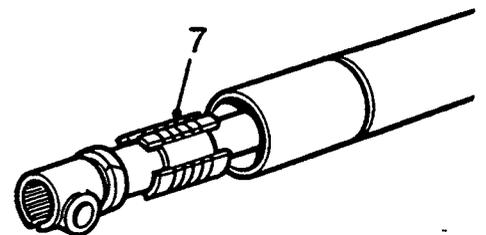
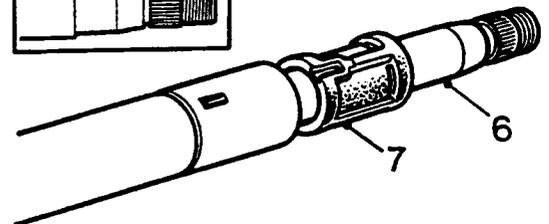
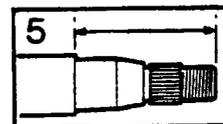

57M0266

5. Measure and record distance from end of inner column to end of outer column.
6. Withdraw inner column from outer column.
7. Remove and discard top and bottom bushes.

STEERING

Assembly

1. Lubricate inside surfaces of replacement bushes with lithium based grease, see **INFORMATION - CAPACITIES, FLUIDS AND LUBRICANTS**.
2. Slide bottom bush on to inner column.
3. Slide inner column into outer column.

Note: Ensure distance from top of outer column to top of inner column is the same as that obtained during dismantling.

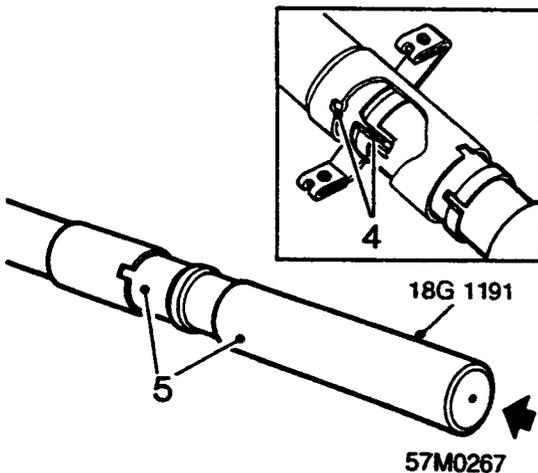

4. Position top bush, chamfered end leading into column ensuring that shouldered slot in bush is located in detent in outer column.
5. Using tool 18G 1191, drift top bush into column.
6. Fit column switch assembly and tighten securing screw.
7. Position steering column lock and lock saddle, fit but do not tighten new shear bolts.
8. Fit steering column, see **Steering column**.
9. Fit steering wheel, see **Steering wheel**.
10. Check steering column lock and ignition/starter switch for correct operation. Tighten steering lock shear bolts until heads shear off.
11. Fit steering column nacelle, see **Steering column nacelle**.

TRACK ROD END

Service Repair No. 57.55.02

Remove

1. Raise front of vehicle.

WARNING: Support on safety stands.

2. Remove road wheel(s).

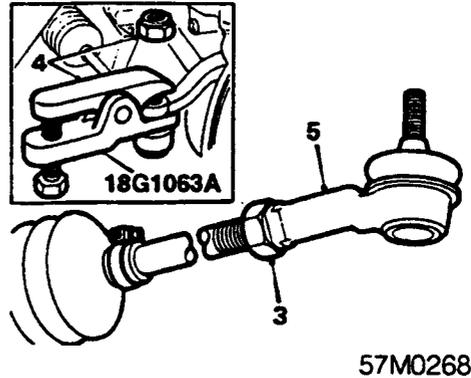

3. Slacken track rod end locknut.
4. Remove track rod end ball joint nut, break taper joint using tool 18G 1063A .

Note: Mark fitted position of track rod end.

5. Unscrew track rod end.

Refit

1. Fit track rod end.

Note: Do not tighten locknut at this stage.

2. Connect track rod end ball joint to steering lever, fit a new nut and tighten to 30 Nm.
3. Fit road wheel(s) and tighten nuts to 60 Nm.
4. Check/adjust front wheel alignment, see **MAINTENANCE**.

5. Remove stand(s) and lower vehicle.



STEERING RACK GAITER

Service Repair No. 57.25.03

Remove

1. Raise front of vehicle.

WARNING: Support on safety stands.

2. Remove road wheel(s).

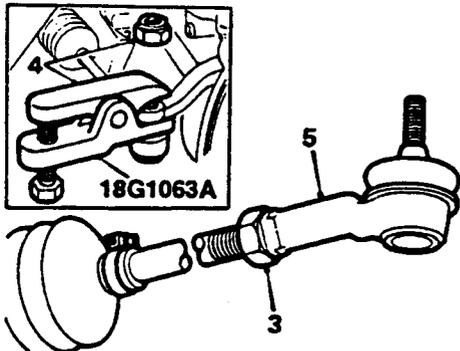

57M0268

3. Slacken track rod end locknut.
4. Remove track rod end ball joint nut, break taper joint using tool 18G 1063A .

Note: Mark fitted position of track rod end.

5. Unscrew track rod end.

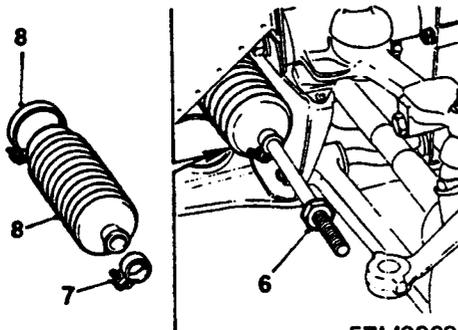

57M0269

6. Remove track rod end locknut.

Note: Mark fitted position of gaiter on track rod.

7. Remove clip securing outer end of gaiter to track rod.
8. Slacken clip securing inner end of gaiter to track rod, remove gaiter, recover clip.

Refit

1. Clean track rod and gaiter location on rack housing.
2. Smear inside end of each gaiter with silicone grease.
3. Position gaiter to rack housing, fit and tighten clip.
4. Position gaiter on track rod, fit and tighten clip.
5. Fit track rod end locknut and track rod end.

Note: Do not tighten locknut at this stage.

6. Connect track rod end ball joint to steering lever, fit new nut and tighten to 30 Nm.
7. Fit road wheel(s) and tighten nuts to 60 Nm.

8. Check/adjust front wheel alignment, see **MAINTENANCE**.

9. Remove stand(s) and lower vehicle.

STEERING LEVER

Service Repair No. 57.55.29

Remove

1. Raise front of vehicle.

WARNING: Support on safety stands.

2. Remove road wheel(s).

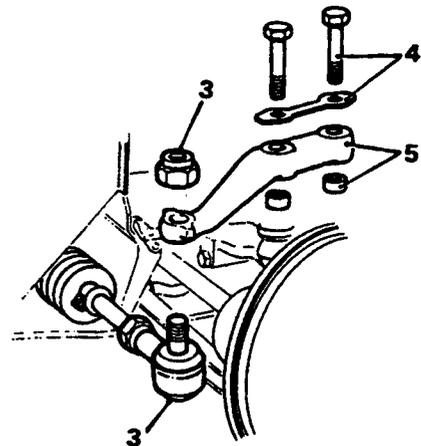

57M0270

3. Remove track rod end ball joint nut, break taper joint using tool 18G 1063A .
4. Bend back locking tabs of tab washer, remove 2 bolts securing steering lever to swivel hub and discard tab washer.
5. Remove steering lever; remove 2 ring dowels.

Refit

1. Check ring dowels for wear, replace if necessary.
2. Insert ring dowels into steering lever.
3. Position steering lever to swivel hub and fit new tab washer. Fit bolts and tighten to 45 Nm.
4. Bend up tabs of tab washer.
5. Connect track rod end ball joint to steering lever, fit a new nut and tighten to 30 Nm.
6. Fit road wheel(s) and tighten nuts to 60 Nm.
7. Remove stand(s) and lower vehicle.

STEERING

STEERING RACK AND PINION

Service Repair No. 57.25.01

Remove

1. Raise front of vehicle.

WARNING: Support on safety stands.

2. Remove road wheel(s).
3. Remove air cleaner, see **MAINTENANCE**.

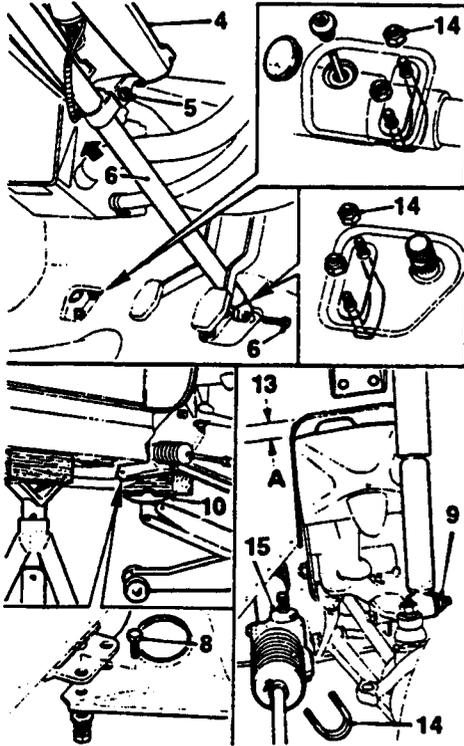

57M0271

4. Remove steering column nacelle, see **Steering column nacelle**.
5. Cut a slot in top of shear bolt securing steering column to mounting bracket, remove and discard bolt.
6. Remove bolt securing inner column to steering rack pinion and release steering column.
7. Remove track rod end ball joint nuts, break taper joints using **18G 1063A**.
8. Remove 4 bolts securing front sub-frame to rear mountings.
9. Remove bolts securing front dampers to suspension top arms, recover spacers and washers.
10. Position jack to support front sub-frame.

CAUTION: Insert a block of wood between lifting pad of jack and sub-frame.

11. Remove 2 bolts securing purge valve, move valve aside.
12. Remove cover from windscreen wiper motor.
13. Remove 2 bolts securing sub-frame turret to body; lower the sub-frame to give a

clearance of 20 mm between turret and body.

14. Remove 4 nuts securing the 2 steering rack 'U' bolts body, release steering rack and recover 'U' bolts and anti-friction strips.
15. Manoeuvre rack out from RH side of vehicle, remove steering rack pinion seal from body.

Refit

1. Check anti-friction strips and pinion to body seal for wear, replace if necessary.
2. Fit steering rack pinion seal to body.
3. Position steering rack to body, fit 'U' bolts and anti-friction strips to body, fit but do not tighten 'U' bolt securing nuts.
4. Raise sub-frame, fit turret to body bolts and tighten to 67 Nm.
5. Fit cover to windscreen wiper motor.
6. Position purge valve to body and secure with bolts.
7. Position front dampers to suspension top arms, fit spacers, washers and bolts, tighten nuts to 48 Nm.
8. Align sub-frame to rear mounting, fit bolts and tighten to 25 Nm.
9. Connect track rod end ball joints to steering levers, fit new nuts and tighten to 30 Nm.
10. Using assistance, centralise steering rack pinion in footwell hole and tighten 'U' bolt nuts to 15 Nm.
11. Fold back floor covering in passenger footwell and remove grommet from floor.
12. Using an Allen key, remove plug from rack.
13. Using assistance, move track rods from side to side until a 6 mm diameter rod can be inserted into the centralising hole in the rack.
14. Position steering column to steering rack pinion ensuring steering wheel spokes are in straight ahead position.
15. Fit but do not tighten a new steering column to mounting bracket shear bolt.

CAUTION: Do not force steering column sideways to align column to mounting bracket. Slacken screws securing mounting bracket to fascia rail and reposition mounting bracket to obtain correct alignment. Tighten mounting bracket screws on completion.

16. Fit steering column to steering rack pinion bolt and tighten to 16 Nm.
17. Tighten steering column to mounting bracket bolt until head shears off.
18. Remove 6 mm rod from rack, fit and tighten plug.
19. Fit grommet to floor and reposition floor covering.
20. Fit air cleaner, see **MAINTENANCE**.
21. Fit road wheels and tighten nuts to 60 Nm.



22. Check/adjust wheel alignment. see **MAINTENANCE**.

STEERING RACK AND PINION OVERHAUL

Service Repair No. 57.25.07

Note: It is not possible to overhaul steering racks fitted from VIN 068303 - RHD or VIN 067688 - LHD. These racks can be identified by means of a plastic plug inserted in the rack damper housing.

Dismantle

1. Remove steering rack, see **Steering rack and pinion**.
2. Hold steering rack housing securely in a soft-jawed vice.

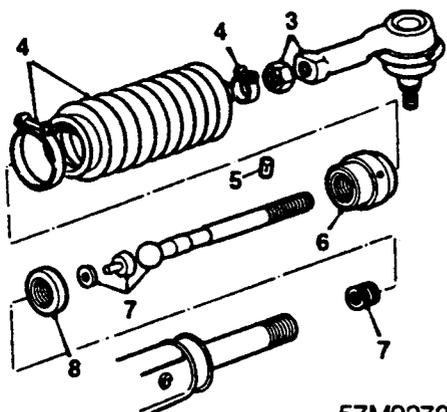

57M0272

3. Slacken track rod end locknuts, remove track rod ends and locknuts.
4. Slacken clips and remove gaiters.
5. Drill out grooved pins retaining the ball housings to steering rack.

CAUTION: Do not drill deeper than 4.0 mm.

6. Remove ball housings using tool 18G 1278.

CAUTION: If ball housings are to be refitted, suitably identify each housing to its respective track rod before removal.

7. Withdraw track rods, ball seats and springs.

CAUTION: If components are to be refitted, suitably identify them to the steering rack before removal.

8. Remove locknuts.

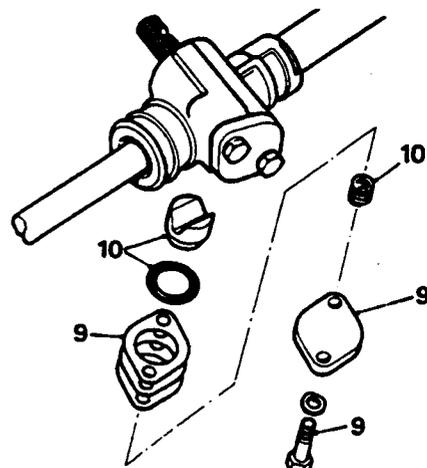

57M0273

9. Remove 2 bolts securing rack damper cover plate, remove plate and collect shims.
10. Remove damper thrust spring, 'O' ring and support yoke, discard 'O' ring.

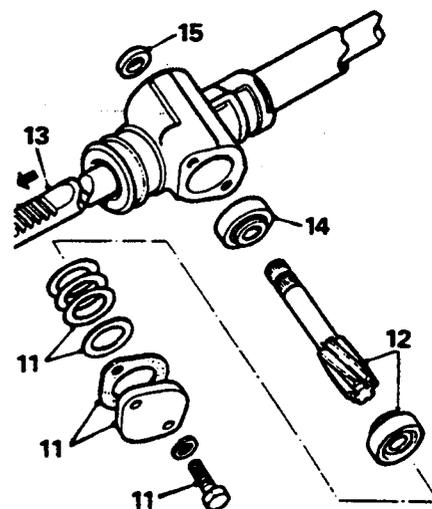

57M0274

11. Remove 2 bolts securing steering rack pinion end cover to rack. Carefully remove cover, gasket and shims.

CAUTION: Do not discard gasket.

12. Push pinion downwards, remove lower bearing and pinion.

13. Withdraw rack from steering rack pinion end of rack housing.

CAUTION: Do not attempt to remove rack from opposite end of rack housing because the rack teeth will damage bush.

14. Remove upper bearing.
15. Remove and discard seal.

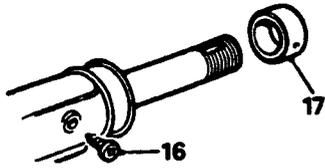

57M0275

16. Remove screw retaining rack bush.
17. Remove rack bush.

Inspect

18. Clean all components.
19. Check rack and pinion teeth for wear.
20. Check bearings for wear and smoothness of operation.
21. Check rack bush, ball housings and seats for wear.
22. Replace components as necessary.

Assembly

Note: Smear all components with recommended grease prior to assembly, see **INFORMATION – CAPACITIES, FLUIDS AND LUBRICANTS.**

1. Press bush into rack housing until it contacts the stop.

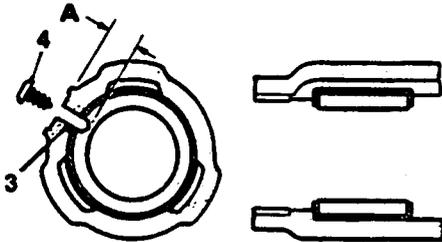

57M0276

2. Drill a 3.0 mm hole into rack bush to a depth of 10.5 mm A.
3. Coat retaining screw with silicone sealant, fit and tighten screw.
4. Check, after tightening screw that bore of bush is not distorted. If distortion is evident, a new bush must be fitted.

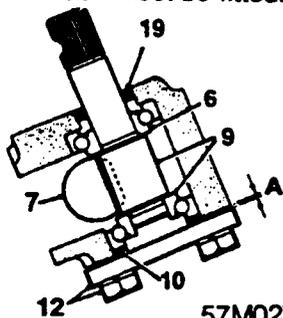

57M0277

5. Fit upper bearing to pinion, insert pinion into housing and push bearing fully into recess; remove pinion.
6. Insert rack into rack housing from pinion housing end.

7. Remove centralising plug from rack housing and position rack to enable a 6.0 mm diameter rod to be inserted through centralising hole in housing and into hole in rack.
8. Fit pinion and lower bearing.
9. Make up a shim pack which must include the standard 1.52 mm thick shim. The shim pack must be sufficiently thick so that when fitted, shims are protruding beyond end face of pinion housing.
10. Fit shim pack, pinion end cover and original gasket.
11. Fit and lightly tighten bolts.
12. Determine pinion bearing pre-load:
 - i) Measure and record gap A.
 - ii) Calculate thickness of shims required to add to, or remove from the shim pack in order to achieve a gap of 0.28 to 0.33 mm between pinion housing and end cover.
13. Remove pinion end cover and shim pack, discard gasket.
14. Select appropriate shims to make up a shim pack of the required thickness.

Note: A Standard shim of 1.52 mm thickness must be included in the shim pack.

15. Fit selected shims ensuring that standard shim is next to pinion end cover.
16. Fit new gasket and pinion end cover.
17. Smear threads of bolts with silicone sealant, fit bolts and tighten to 15 Nm.
18. Smear a new pinion oil seal with recommended grease and fit to pinion housing.

Note: When fitted, seal must be flush with face of housing.

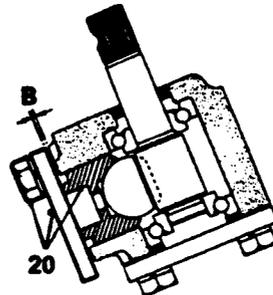

57M0278

19. Fit support yoke and cover plate, fit and tighten bolts until rack is lightly clamped by the yoke.

Note: Do not fit 'O' ring, shims or thrust spring at this stage.

20. Remove 6 mm diameter rod from centralising hole.
21. Rotate pinion by hand through 180° in each direction and if necessary, slacken cover plate bolts until pinion moves freely with no trace of binding.
22. Measure and record gap B between cover plate and pinion housing.



23. Add to the measurement obtained the support yoke to cover plate clearance and calculate thickness of shims required to fit between the cover plate and housing.

DATA: Support yoke to cover plate clearance = 0.05 to 0.13 mm

24. Remove cover plate and support yoke.
25. Pack pinion housing with 25 grams of recommended grease, see **INFORMATION - CAPACITIES, FLUIDS AND LUBRICANTS**.

Note: Move rack from side to side to distribute grease along rack teeth.

26. Fit support yoke, new 'O' ring, thrust spring and selected shims.
27. Fit cover plate.
28. Smear threads of bolts with silicone sealant, fit bolts and tighten to 15 Nm.
29. Rotate pinion by hand through 180° in each direction, ensure that there is no tightness or binding.
30. Fit tools 18G 207 and 18G 207A to pinion.
31. Check that torque required to start pinion movement does not exceed 0.40 Nm.

CAUTION: If torque exceeds above figure, it will be necessary to repeat shimming operations.

32. Centralise rack and insert 6.0 mm diameter rod into centralising hole.

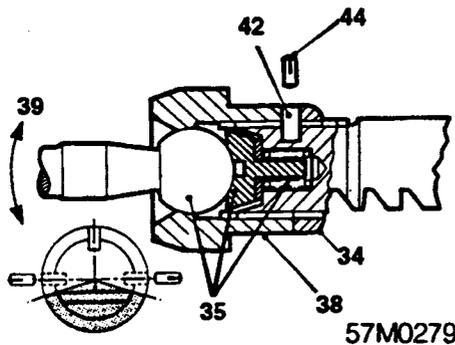

33. Screw ball housing locknuts on each end of rack to the limits of the thread.
34. Fit thrust spring, ball seat and track rod into ball housing.
35. Lubricate ball and housing with recommended grease, see **INFORMATION - CAPACITIES, FLUIDS AND LUBRICANTS**.
36. Tighten ball housing until ball end of track rod is just pinched.

CAUTION: If original components are being refitted, ensure they are fitted to their respective sides of steering rack.

37. Screw locknuts up to ball housings and tighten using tool 18G 1278.

CAUTION: Ensure ball housings do not turn.

38. Attach a spring balance to end of each track rod and check that force required to articulate rod is between 0.36 to 0.59 kgfm.
39. If necessary, adjust ball housing until force is correct.
40. Drill a 3.97 mm diameter hole to a depth of 8.00 mm between locknut and ball housing.

CAUTION: Do not drill hole in the arc covered by the rack teeth. If locknut and ball housing have previously been drilled, the new hole must be at 90° from the original. Components must not be drilled more than three times.

41. Remove all traces of swarf.
42. Drive a new grooved pin into hole, peen over edge of hole in four positions.
43. Apply silicone grease to ends of rack gaiters, fit gaiters and tighten clips.
44. Fit track rod ball joint locknuts.
45. Screw track rod ends equally onto track rods until ball pin centres are 1057 mm apart then lightly tighten locknuts.
46. Fit steering rack, see **Steering rack and pinion**.

SUSPENSION

CONTENTS

Description and Operation	Page
Front suspension components	3
Rear suspension components	5
Front hub components	6

Repairs	Page
Front bump and rebound rubbers	1
Front damper	1
Rear damper	2
Upper arm - front suspension	3
Lower arm - front suspension	4
Upper ball joint	5
Lower ball joint	6
Front hub bearings	7
Rear hub bearings	9
Rubber cone spring unit - front	10
Rubber cone spring unit - rear	11
Radius arm pivot bearings	11
Front sub - frame mounting - front	13
Front sub - frame mounting - rear	13
Rear sub - frame mounting - front	14
Rear sub - frame mounting - rear	14



SUSPENSION

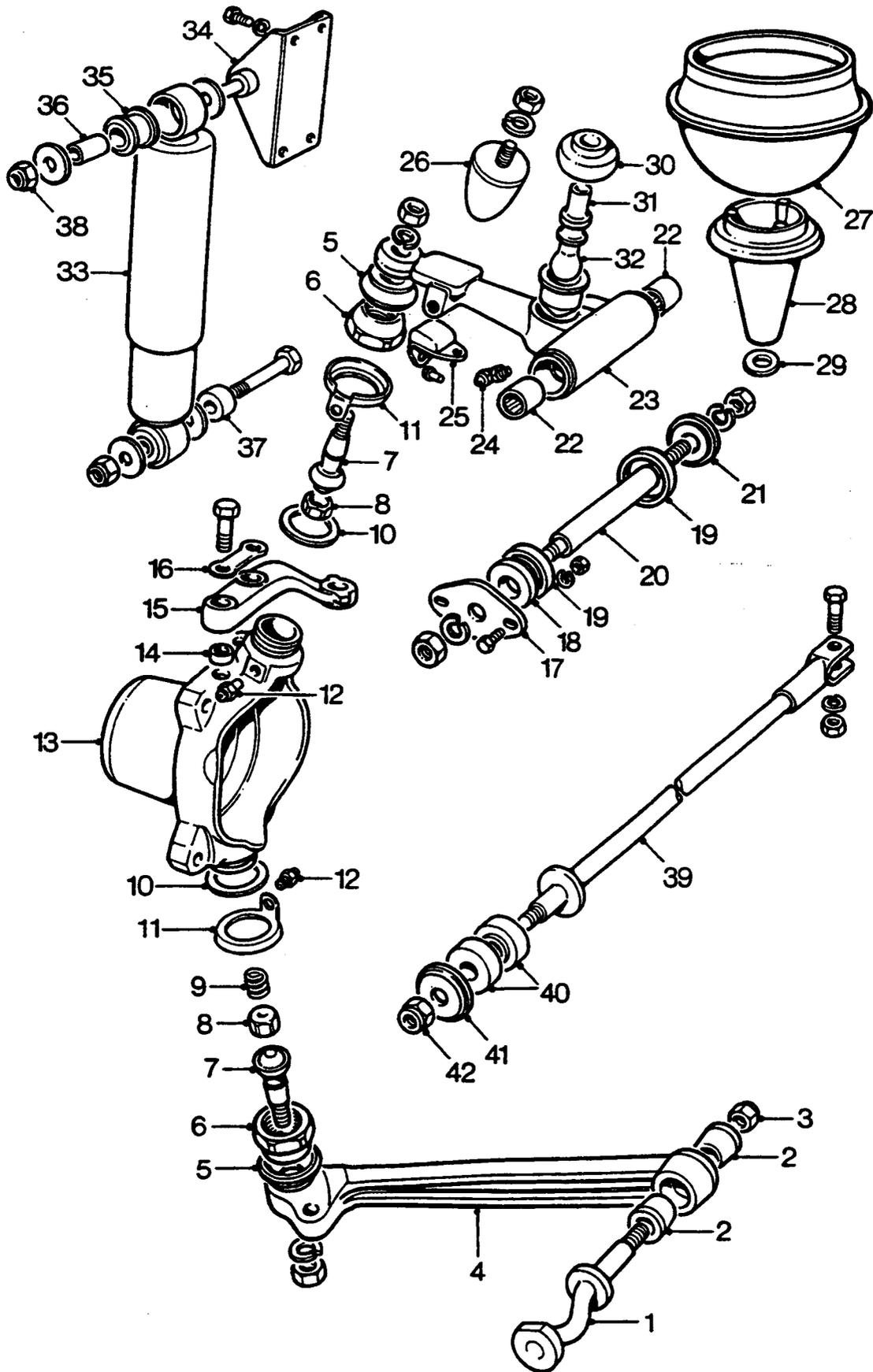

60M0046

**FRONT SUSPENSION COMPONENTS**

1. Pivot shaft
2. Bushes
3. Locknut
4. Lower support arm
5. Dust cover
6. Ball pin retainer
7. Ball pin
8. Ball seat
9. Spring - lower ball joint
10. Shims
11. Lockwasher
12. Grease nipple
13. Swivel hub
14. Ring dowel
15. Steering arm
16. Lockwasher
17. Retaining plate
18. Thrust collar
19. Sealing rings
20. Pivot shaft
21. Thrust washer
22. Needle roller bearing
23. Upper arm
24. Grease nipple
25. Rebound rubber
26. Bump rubber
27. Cone spring
28. Front strut
29. Packing washers (if fitted)
30. Dust cover
31. Knuckle end
32. Ball socket
33. Damper
34. Damper mounting bracket
35. Ferrule - rubber
36. Ferrule sleeve
37. Spacer - damper to upper arm
38. Locknut
39. Tie - rod
40. Rubber mountings
41. Cup washer
42. Locknut

SUSPENSION

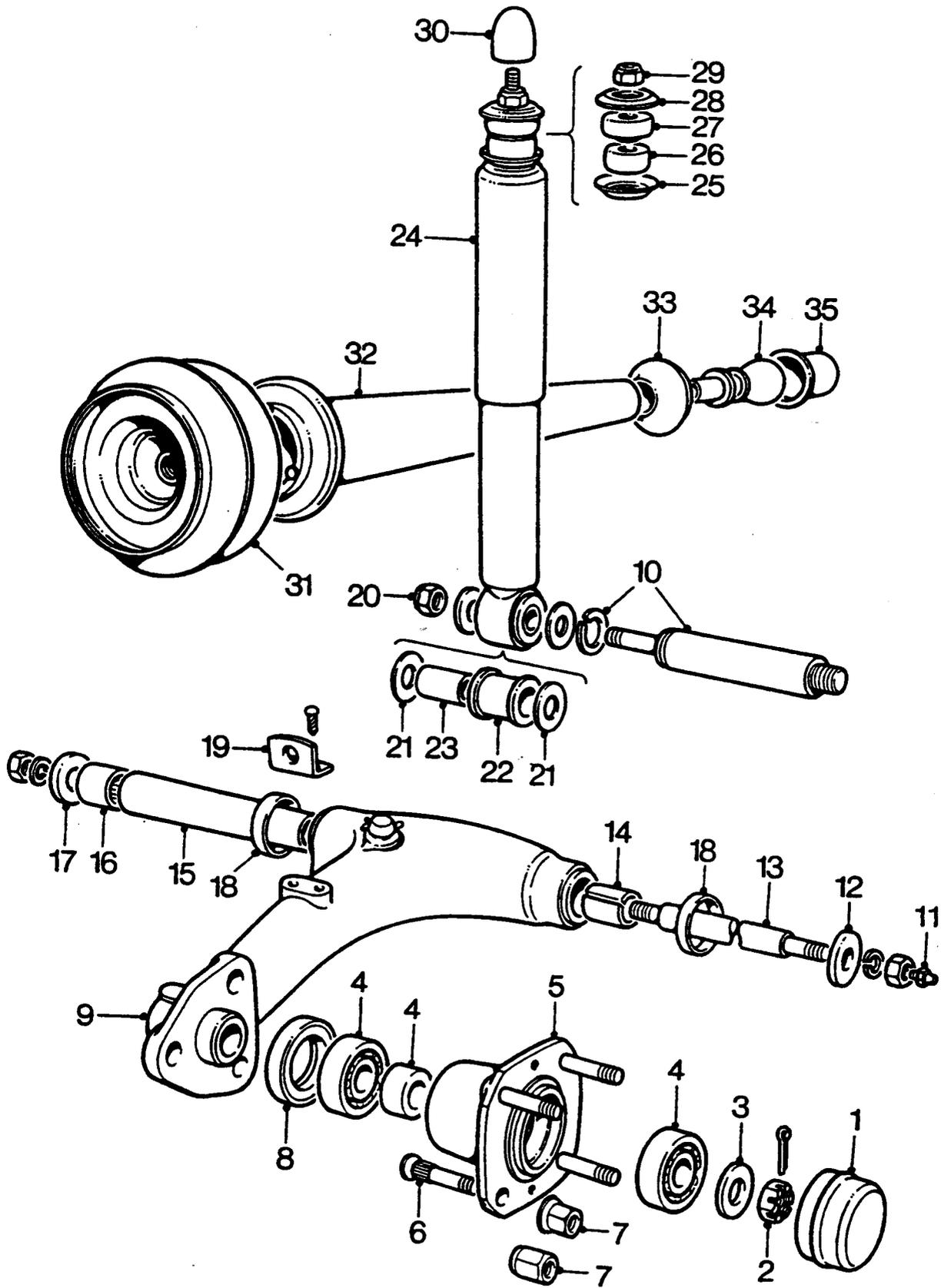

60M0047

**REAR SUSPENSION COMPONENTS**

1. Grease retaining cap
2. Nut - stub shaft
3. Washer
4. Taper bearing and spacer
5. Rear hub
6. Wheel stud
7. Wheel nut
8. Oil seal
9. Radius arm
10. Stub shaft and circlip
11. Grease nipple
12. Thrust washer
13. Pivot shaft
14. Bush - bearing
15. Lubricating tube
16. Needle roller bearing
17. Thrust washer
18. Sealing rings
19. Hose bracket
20. Locknut - damper to pin
21. Washer
22. Ferrule - rubber
23. Ferrule sleeve
24. Damper
25. Washer
26. Bush
27. Spigoted bush
28. Washer
29. Locknut
30. Buffer
31. Cone spring
32. Rear strut
33. Dust cover
34. Knuckle end
35. Ball socket

SUSPENSION

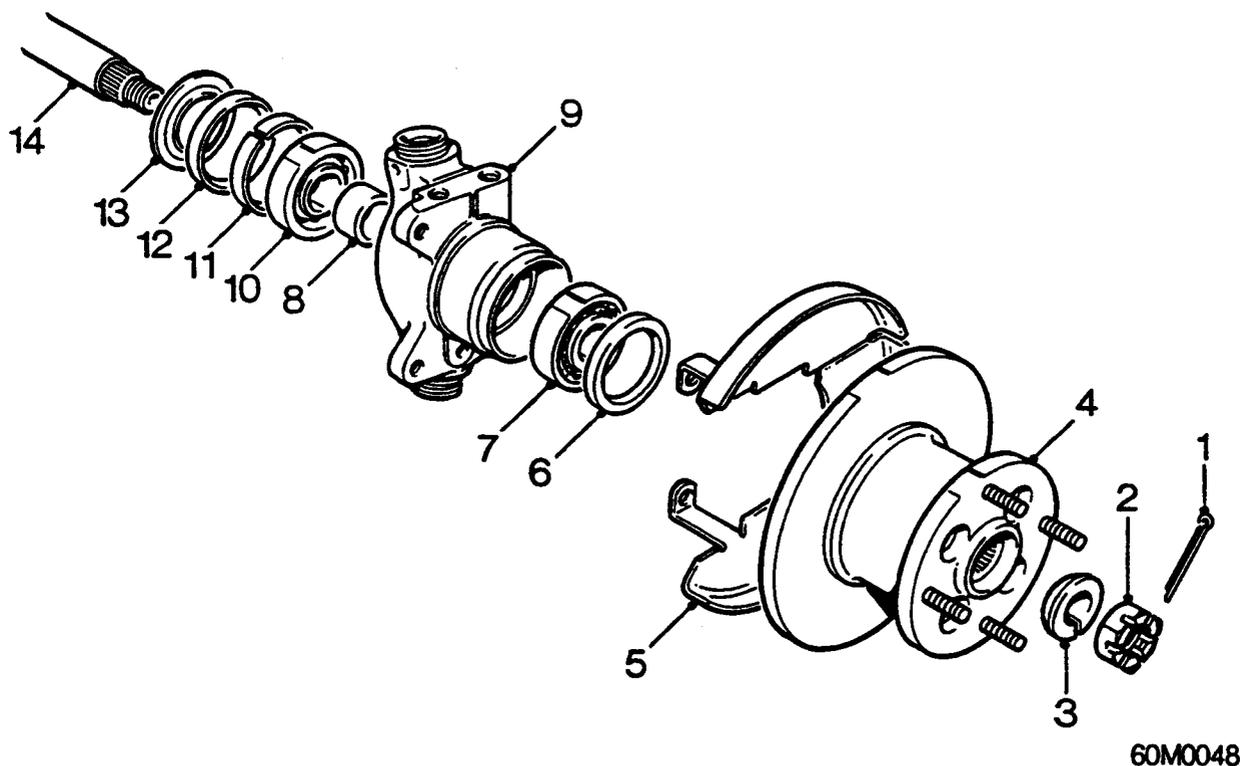

FRONT HUB COMPONENTS

- | | |
|----------------------------|--------------------------|
| 1. Split pin | 9. Swivel hub |
| 2. Hub nut | 10. Taper roller bearing |
| 3. Outer collar - split | 11. Split spacer |
| 4. Drive flange/brake disc | 12. Inner oil seal |
| 5. Disc shield | 13. Bearing water shield |
| 6. Outer oil seal | 14. Drive shaft |
| 7. Taper roller bearing | |
| 8. Inner spacer | |



FRONT BUMP AND REBOUND RUBBERS

Service Repair No. 68.15.01

Remove

1. Raise front of vehicle, one side.

WARNING: Support on safety stands.

2. Remove road wheel(s).
3. Remove front strut assembly, see **Upper arm - front suspension.**

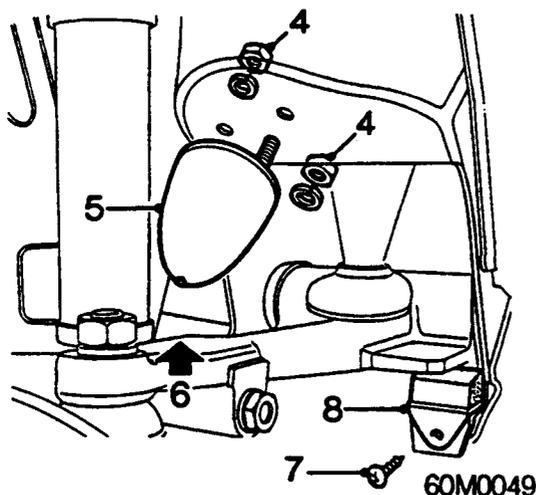

4. Remove two nuts and washers securing bump rubber to sub - frame.
5. Remove bump rubber.
6. Place a jack under lower arm and raise until upper arm is clear of rebound rubber.
7. Remove screw securing rebound rubber to sub - frame.
8. Remove rebound rubber.

Refit

1. Fit rebound rubber, tighten screw.
2. Lower jack from lower arm.
3. Fit bump rubber
4. Tighten nuts securing bump rubber to sub - frame.
5. Fit front strut assembly, see **Upper arm - front suspension.**
6. Fit road wheel and tighten nuts to 60 Nm.
7. Remove stand(s) and lower vehicle.

FRONT DAMPER

Service Repair No. 68.15.16.

Remove

1. Raise front of vehicle, one side.

WARNING: Support on safety stands.

2. Remove road wheel(s).

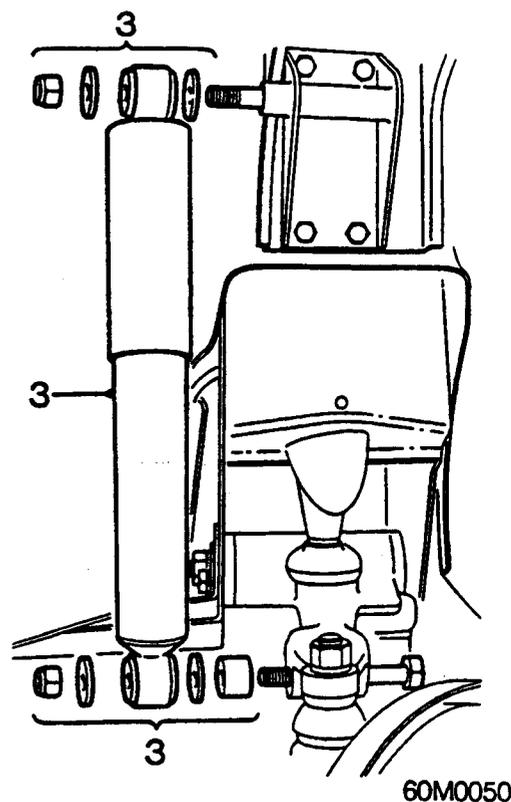

3. Unscrew locknuts and remove damper, washers and spacers.

Note: Store damper upright if it is to be refitted.

Refit

1. Hold new damper upright in vice and compress and extend it through its full stroke until there is no free travel when changing direction of stroke.
2. Position damper on locating bolts.
3. Fit washers and tighten locknuts to; damper upper locknut = 37Nm, damper lower locknut = 48Nm.
4. Fit road wheel and tighten nuts to 60 Nm.
5. Remove stand(s) and lower vehicle.

SUSPENSION

REAR DAMPER

Service Repair No.

Left hand - 68.15.22.

Right hand - 68.15.23.

Remove

1. *Left hand damper:* Remove fuel tank, see **FUEL DELIVERY SYSTEM**.
2. Raise rear of vehicle, one side.

WARNING: Support on safety stands.

3. Remove road wheel(s).

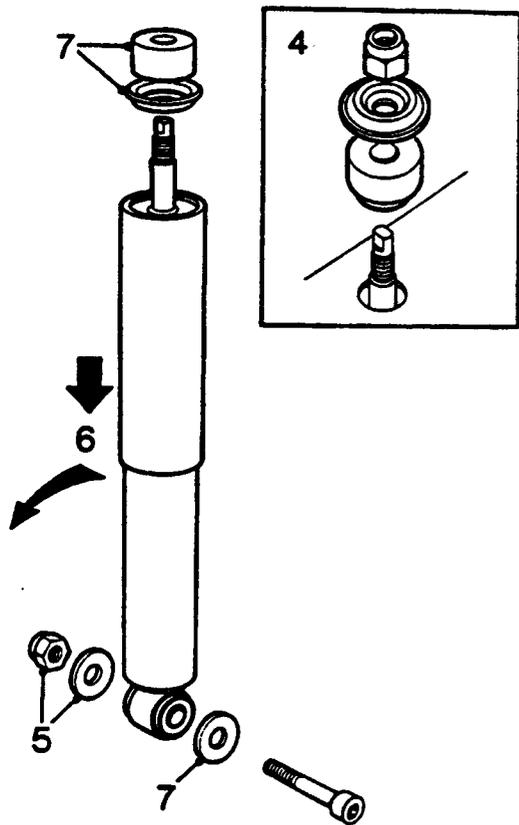

60M0051

4. From inside boot, hold damper stud, unscrew locknut and remove the washer and spigoted bush.
5. Remove locknut and washer securing damper to stub shaft.
6. Compress damper, move it rearwards and remove it from stub shaft.
7. Remove rubber bush and washer from top of damper and plain washer from stub shaft.

Note: Store damper upright if it is to be refitted.

Refit

1. Hold new damper upright in vice and compress and extend it through its full stroke until there is no free travel when changing direction of stroke.
2. Fit rubber bush and washer to top of the damper and plain washer to stub shaft.
3. Position damper to stub shaft and tighten nut.
4. From inside boot, fit washer and spigoted bush, hold damper stud and tighten locknut.
5. *Left hand damper:* Fit fuel tank, see **FUEL DELIVERY SYSTEM**.
6. Fit road wheel and tighten nuts to 60 Nm.
7. Remove stand(s) and lower vehicle.



UPPER ARM - FRONT SUSPENSION

Service Repair No. 68.20.02.

Remove

1. Raise front of vehicle, one side.

WARNING: Support on safety stands.

2. Remove road wheel(s).

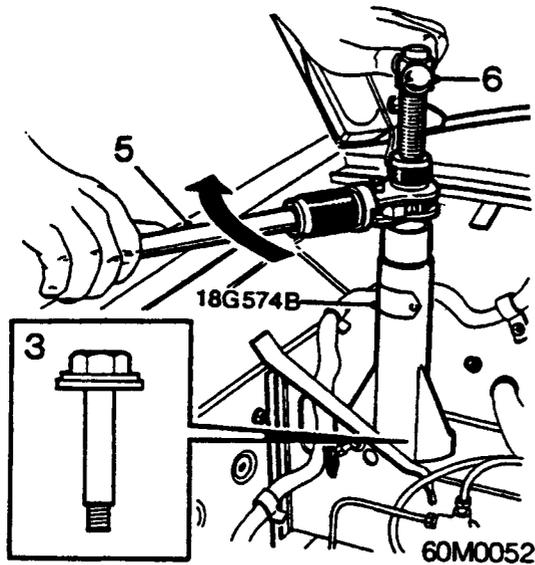

3. Remove bolt securing sub - frame to body crossmember.
4. Fit tool 18G 574B and screw centre screw 9 complete turns into spring unit.
5. Turn ratchet handle until the centre nut makes contact with body of tool.
6. Hold centre screw to prevent rotation and turn ratchet handle clockwise to compress cone spring enough to allow it to be removed.

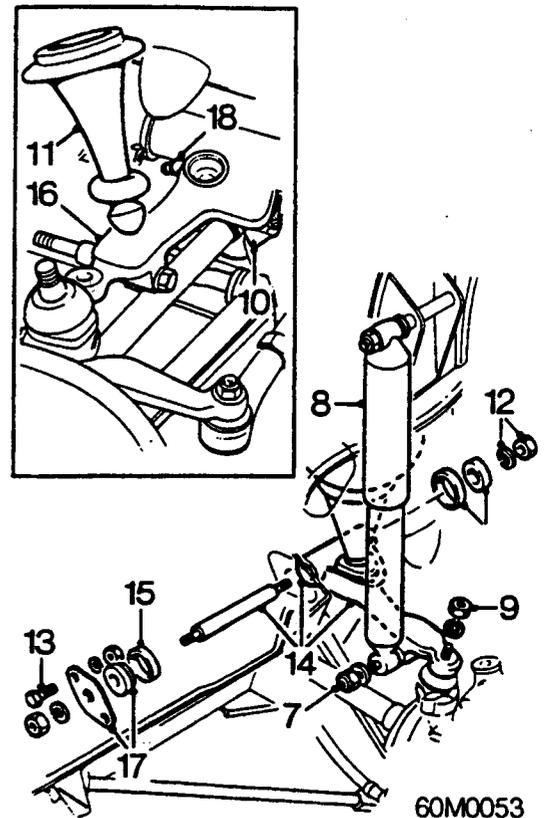

7. Remove nut securing damper to upper arm, collect washers.
 8. Move damper aside.
 9. Remove retaining nut and using tool 18G 1063 release upper ball joint.
- Note: Support driving flange to avoid straining the brake hose.**
10. Remove screw securing rebound rubber, remove rebound rubber.
 11. Lever knuckle end from its seat in upper arm, extract front strut assembly.
 12. Remove nut and spring washer from rear end of the pivot shaft.
 13. Remove 2 screws securing thrust collar retaining plate to sub - frame.
 14. Lever pivot arm forward, twist upper arm outwards and pull from pivot shaft.
 15. Remove thrust washer and seals from upper arm.
 16. Remove upper arm assembly.
 17. Remove thrust collar from pivot shaft.
 18. Remove grease nipple.

SUSPENSION

Overhaul

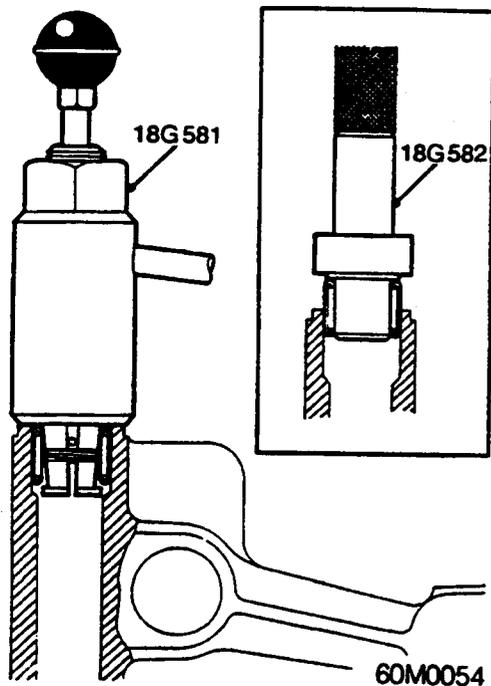

1. Hold upper arm in vice and extract needle roller bearings using tool 18G 581.
2. Press needle roller bearings, with their marked ends outwards into the upper arm using tool 18G 582.
3. Smear bearings with grease.

Refit

1. Fit and tighten grease nipple.
2. Refit thrust collar to pivot shaft.
3. Position upper arm in sub - frame.
4. Fit rear thrust washers and seals to upper arm.
5. Fit upper arm to pivot shaft.
6. Fit thrust collar retaining plate, secure with screws.
7. Fit pivot shaft spring washer and nut, tighten to 72Nm.
8. Fit front strut assembly to upper arm.
9. Fit rebound rubber.
10. Fit upper ball joint and tighten nut to 52Nm.
11. Position damper.
12. Fit nut securing damper to upper arm, tighten to 48Nm.
13. Fit cone spring.
14. Remove tool 18G 574B.
15. Fit bolt securing sub - frame to body crossmember.
16. Fit road wheel and tighten nuts to 60Nm.
17. Remove stand(s) and lower vehicle.

LOWER ARM - FRONT SUSPENSION

Service Repair No. 68.20.10.

Remove

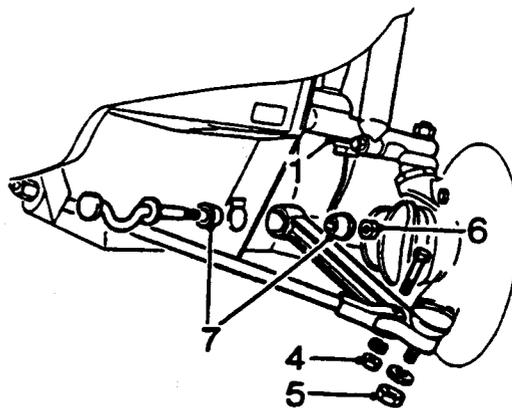

60M0055

1. Insert packing wedge between upper arm and rebound rubber.
 2. Raise front of vehicle, one side.
- WARNING: Support on safety stands.**
3. Remove road wheel(s).
 4. Remove bolt and disconnect tie - rod from lower arm.
 5. Remove nut and release lower ball joint using tool 18G 1063.
 6. Remove nut and washer from rear end of pivot shaft.
 7. Remove the lower arm and mounting rubbers.

Refit

1. Position lower arm and refit mounting rubbers.
2. Fit pivot shaft nut. DO NOT tighten.
3. Fit lower ball joint, tighten nut to 52Nm.
4. Position tie rod to lower arm, fit bolt and tighten nut to 26Nm.
5. Fit road wheel and tighten nuts to 60Nm.
6. Remove stand(s) and lower vehicle.
7. Tighten pivot shaft nut to 45Nm.



UPPER BALL JOINT

Service Repair No. 68.20.43.

Remove

1. Raise front of vehicle, one side.

WARNING: Support on safety stands.

2. Remove road wheel(s).

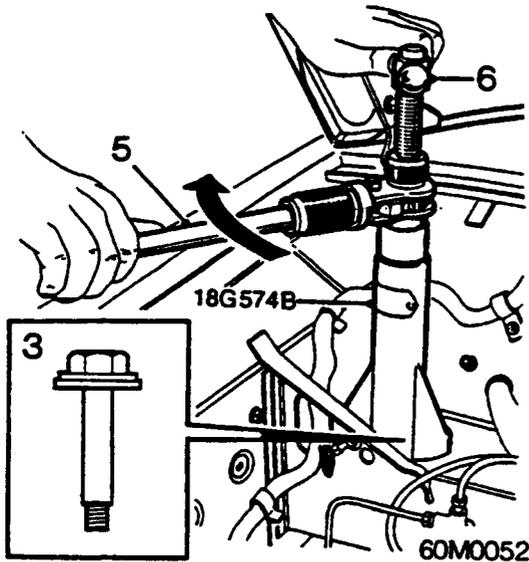

3. Remove bolt securing sub - frame to body crossmember.
4. Fit tool 18G 574B and screw centre screw 9 complete turns into spring unit.
5. Turn ratchet handle until the centre nut makes contact with body of tool.
6. Hold centre screw to prevent rotation and turn ratchet handle clockwise to compress cone spring enough to allow top arm to be lifted.
7. Support the lower arm.
8. Remove retaining nut and using tool 18G 1063 release upper ball joint.

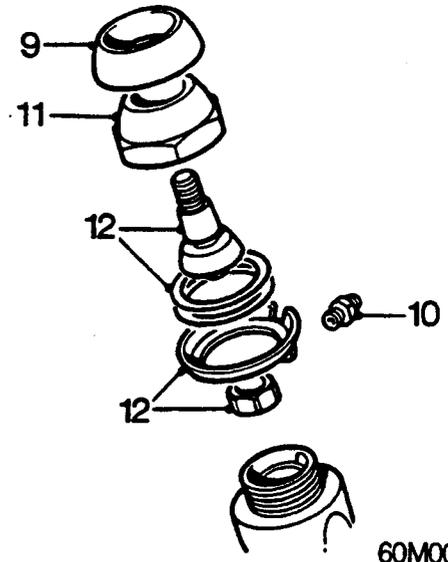

9. Remove dust cover.
10. Remove grease nipple.
11. Knock back lockwasher tab and unscrew ball pin retainer, using tool 18G 587.
12. Remove ball pin, seat, shims and lockwasher.

Refit

1. Thoroughly clean all components. Fit new parts as necessary.

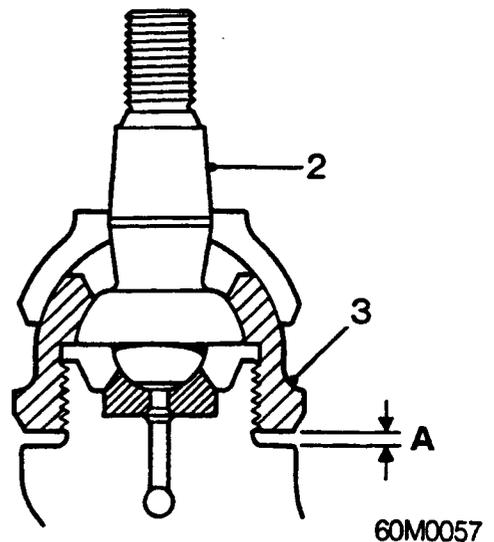

2. Assemble ball pin without shims and lockwasher.
3. Tighten retainer nut until there is no free movement between ball pin and its seat, but ball pin is free to swivel.
4. Measure gap 'A' between retainer nut and hub.
5. Deduct 0.90 mm. from gap measured to find thickness of shim required.

Note: The ball pin must have no nip to 0.08 mm end - float. Add a further 0.05 mm shim if necessary.

SUSPENSION

6. Select shim size which will set the correct gap.
Shims available in 0.05 mm, 0.08 mm, 0.13 mm, 0.25 mm and 0.51 mm sizes.

Note: The ball joint should be able to rotate freely in all planes after adjustment has taken place.

7. Pack the joint with grease and assemble complete with lockwasher and grease nipple.
8. Tighten the retainer nut to 102Nm.
9. Knock over lockwasher tab.
10. Refit dust cover.
11. Fit upper arm ball joint and tighten nut to 52Nm.
12. Remove tool **18G 574B**.
13. Fit bolt securing sub - frame to body crossmember.
14. Fit road wheel and tighten nuts to 60Nm.
15. Remove stand(s) and lower vehicle.

LOWER BALL JOINT

Service Repair No. 68.20.44.

Remove

1. Remove swivel hub assembly, see **Front hub bearings**.
2. Hold hub in vice with ball joint uppermost.

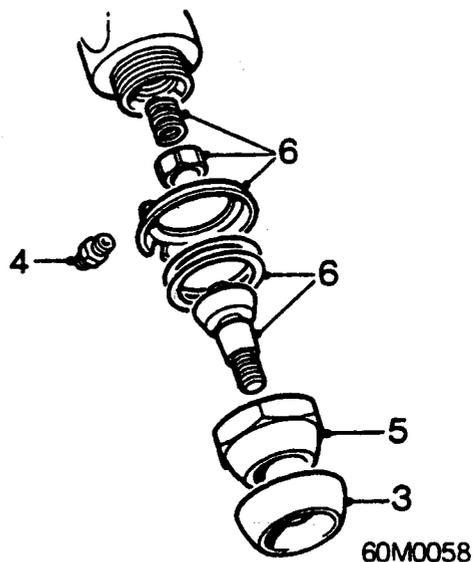

3. Remove dust cover.
4. Remove grease nipple.
5. Knock back lockwasher tab and unscrew ball pin retainer, using tool **18G 587**.
6. Remove ball pin, shims, lockwasher, seat and spring.



Refit

1. Thoroughly clean all components. Fit new parts as necessary.

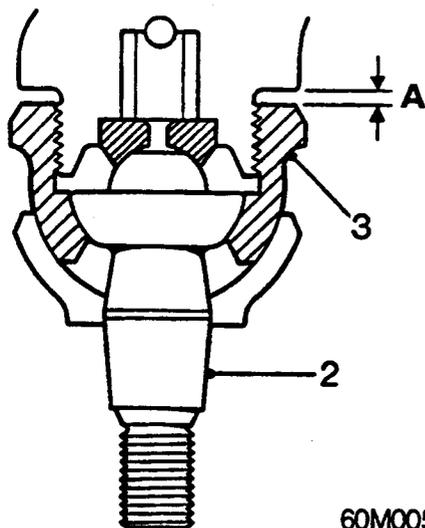

2. Assemble ball pin without shims, spring and lockwasher.
3. Tighten retainer nut until there is no free movement between ball pin and its seat, but ball pin is free to swivel.
4. Measure gap 'A' between retainer nut and hub.
5. Deduct 0.90 mm from gap measured to find thickness of shim required.

Note: The ball pin must have no nip to 0.08 mm end - float. Add a further 0.05 mm shim if necessary.

6. Select shim size which will set the correct gap.
Shims available in 0.05 mm, 0.08 mm, 0.13 mm, 0.25 mm and 0.51 mm sizes.

Note: The ball joint should be able to rotate freely in all planes after adjustment has taken place.

7. Pack joint with grease and assemble complete with spring, seat, lockwasher and grease nipple.
8. Tighten retainer nut to 102Nm.
9. Knock over lockwasher tab.
10. Refit dust cover.
11. Refit swivel hub, see Front hub bearings.

FRONT HUB BEARINGS

Service Repair No. 68.25.13

Remove

1. Raise front of vehicle, one side.
- WARNING:** Support on safety stands.
2. Remove road wheel(s).
 3. Extract split pin and slacken hub nut.

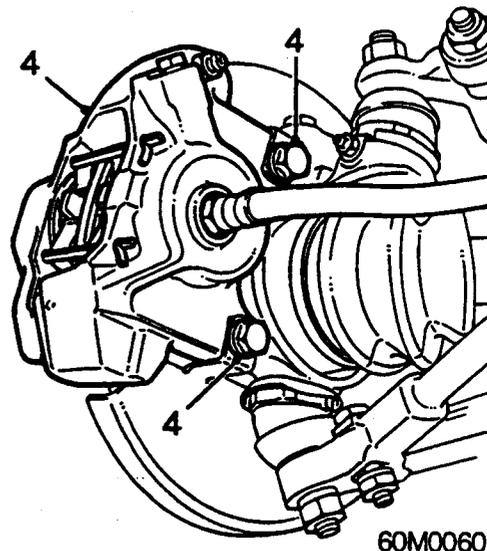

4. Remove 2 bolts and release brake caliper from hub.

Note: Support caliper ensuring hose is not strained.

SUSPENSION

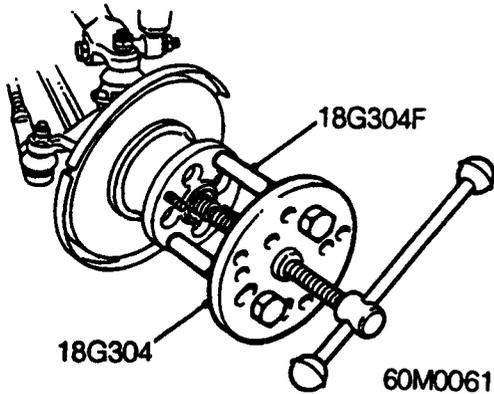
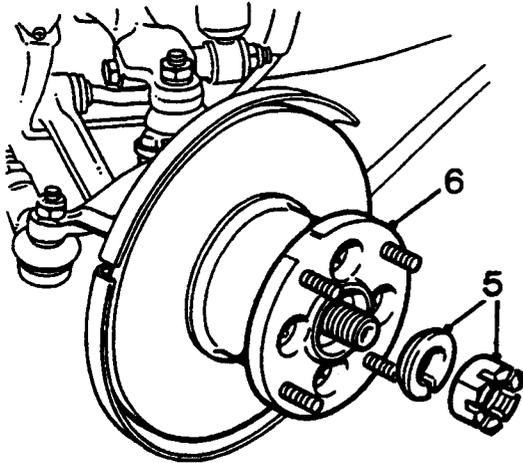

5. Remove hub nut and split collar.
6. Using tools 18G 304 and 18G 304F pull drive flange and brake disc from drive shaft.

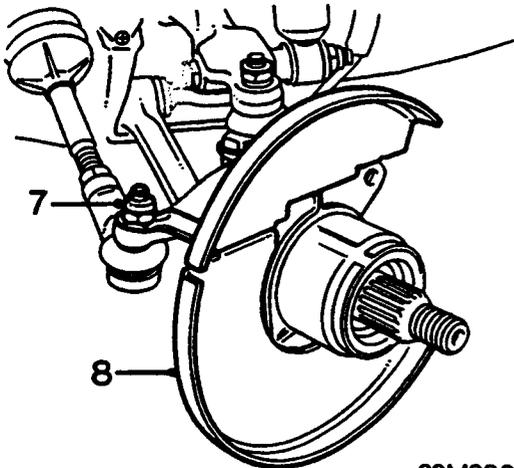

7. Remove retaining nut and using tool 18G 1063 release steering tie rod ball joint from steering arm.
8. Remove water shield.

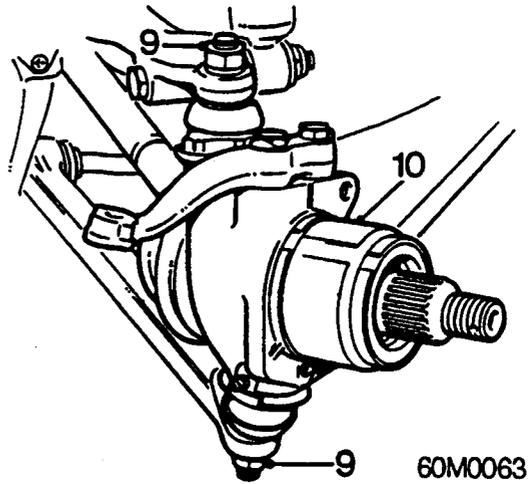

9. Remove retaining nuts and using tool 18G 1063 release upper and lower ball joints.
10. Release hub assembly from drive shaft.
Do not carry out further dismantling if component is removed for access only

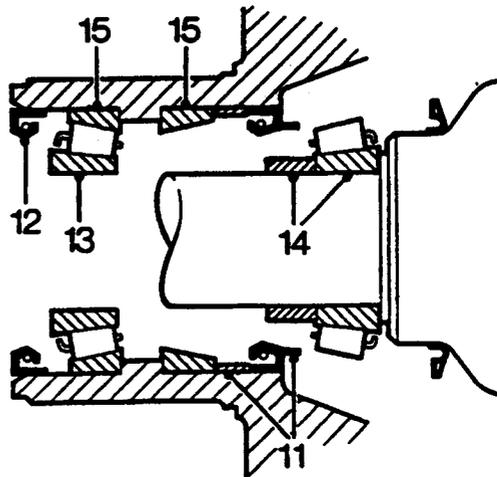

11. Extract inner oil seal and spacer.
12. Extract outer oil seal.
13. Remove outer bearing race from hub.
14. Remove spacer and inner bearing race from drive shaft.
15. Drive bearing outer races out of hub.



Refit

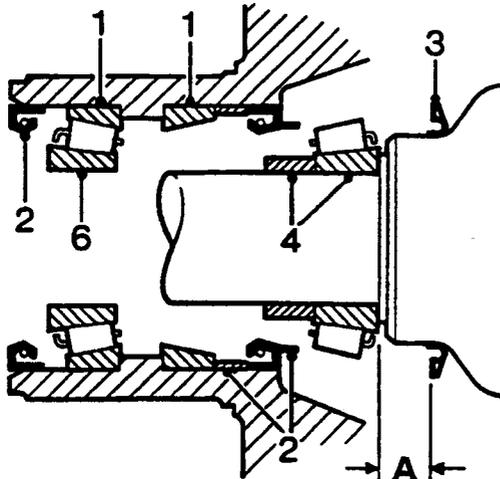

60M0065

1. Press new outer bearing shells into hub until they contact machined shoulder. Pack bearings with grease.

Note: Do not fill the space between bearings with grease.

2. Using tools 18G 134 and 18G 134DO fit oil seals and inner oil seal spacer. Pack space between the bearings and oil seals with grease.

Note: The inner oil seal has a lip on its outer face.

3. Position water shield 6 mm, 'A' onto drive shaft. Fill sealing face of water shield with grease.
4. Fit drive shaft to hub.
5. Fit outer bearing race to hub assembly.
6. Fit upper and lower ball joints, tighten nuts to 52Nm.
7. Fit steering arm ball joint, tighten nut to 30Nm.
8. Fit drive flange and brake disc assembly.
9. Refit split collar and tighten hub nut to 260Nm.
10. Align nut to next split pin hole and fit new split pin.
11. Refit brake caliper, tighten bolts to 52Nm.
12. Fit road wheel and tighten nuts to 60Nm.
13. Remove stand(s) and lower vehicle.

REAR HUB BEARINGS

Service Repair No. 68.25.38.

Remove

1. Release handbrake
2. Raise rear of vehicle, one side.

WARNING: Support on safety stands.

3. Remove road wheel(s).
4. Slacken brake shoe adjuster.

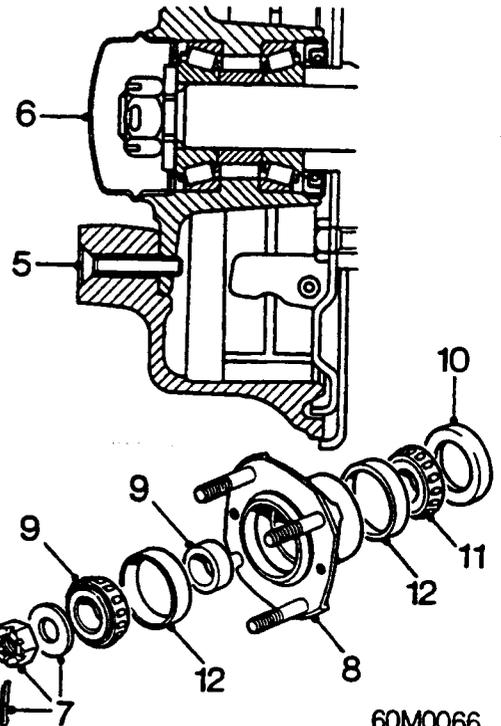

60M0066

5. Remove 2 retaining screws and remove brake drum.

Note: Wash all dust from backplate assembly and drum.

6. Prise off grease retaining cap
7. Extract split pin, unscrew hub nut and remove washer.

Note: The left hand hub has a left hand thread, The right hand hub has a right hand thread.

8. Pull hub assembly from drive shaft.
9. Remove inner race of outer bearing, remove spacer.
10. Extract oil seal.
11. Remove inner race of inner bearing.
12. Drive out bearing outer races from hub.

SUSPENSION

Refit

1. Thoroughly clean all components, discard oil seal.
2. Replace components as necessary.
3. Pack new bearing with grease and lubricate oil seal.
4. Press bearings into hub assembly.
5. Fit oil seal.

Note: Fitted with the lip AWAY from bearing.

6. Fit hub assembly to drive shaft.
7. Fit washer and tighten hub nut to 80Nm
8. Align nut to next split pin hole and fit new split pin.
9. Fit grease retaining cap.
10. Fit brake drum, secure with screws.
11. Adjust brakes, see **MAINTENANCE**.
12. Fit road wheel and tighten nuts to 60Nm.
13. Remove stand(s) and lower vehicle.

RUBBER CONE SPRING UNIT - FRONT

Service Repair No. 68.30.62.

Remove

1. Remove the upper arm, see **Upper arm - front suspension**.

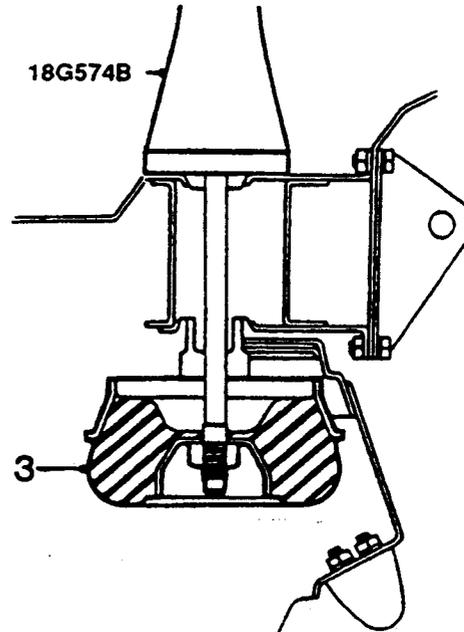

60M0067

2. Hold centre screw of tool **18G 574B** to prevent rotation, turn ratchet anti-clockwise to release spring compression.
3. Remove tool and extract spring unit from inside the subframe tower.

Refit

1. Position spring unit to subframe.
2. Turn ratchet on tool **18G 574B** clockwise to compress spring.
3. Fit upper arm, see **Upper arm - front suspension**.



RUBBER CONE SPRING UNIT - REAR

Service Repair No. 68.30.64.

Remove

1. Raise rear of vehicle, one side.

WARNING: Support on safety stands.

2. Remove road wheel(s).
3. Remove rear damper.

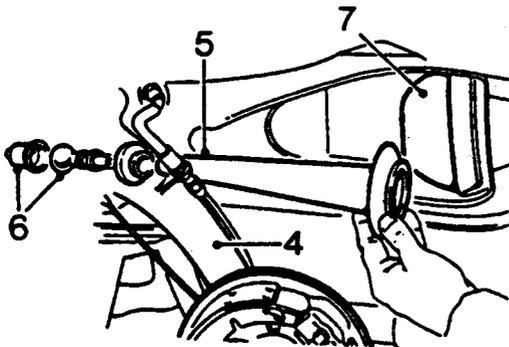

60M0068

4. Remove radius arm, see **Radius arm pivot bearings**.
5. Pull strut from spring unit and knuckle joint assembly.
6. Drive knuckle joint from strut.
7. Release rubber cone from sub - frame.

Refit

1. Assemble knuckle joint.

Note: Lubricate with grease.

2. Locate joint in radius arm.
3. Position rubber cone in sub - frame.
4. Engage strut to knuckle joint and fit radius arm, see **Radius arm pivot bearings**.
5. Fit rear damper.
6. Fit road wheel and tighten nuts to 60 Nm.
7. Remove stand(s) and lower vehicle.

RADIUS ARM PIVOT BEARINGS

Service Repair No. 68.35.10

Remove

1. Raise rear of vehicle, one side.

WARNING: Support on safety stands.

2. Remove road wheel(s).

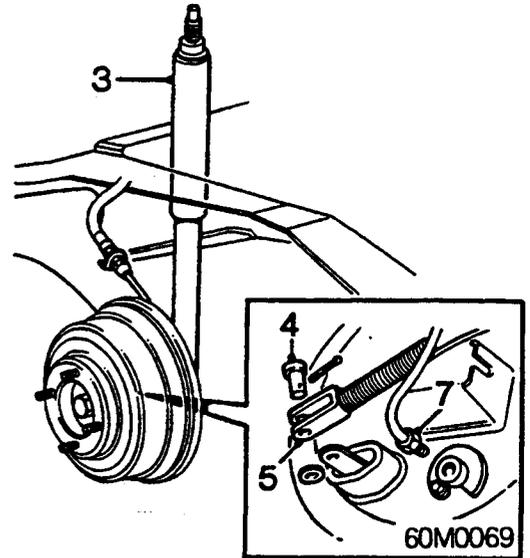

60M0069

3. Support radius arm and remove rear damper.
4. Remove clevis pin from handbrake cable.
5. Disconnect handbrake cable from brake lever.
6. Move cable aside.
7. Undo brake pipe union from brake back plate.

CAUTION: Plug the connections.

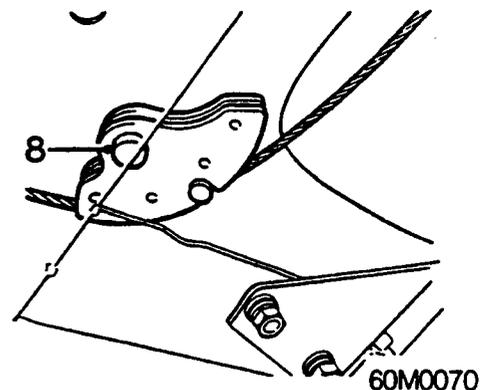

60M0070

8. Remove split pin from clevis pin and remove handbrake cable quadrant from radius arm.

SUSPENSION

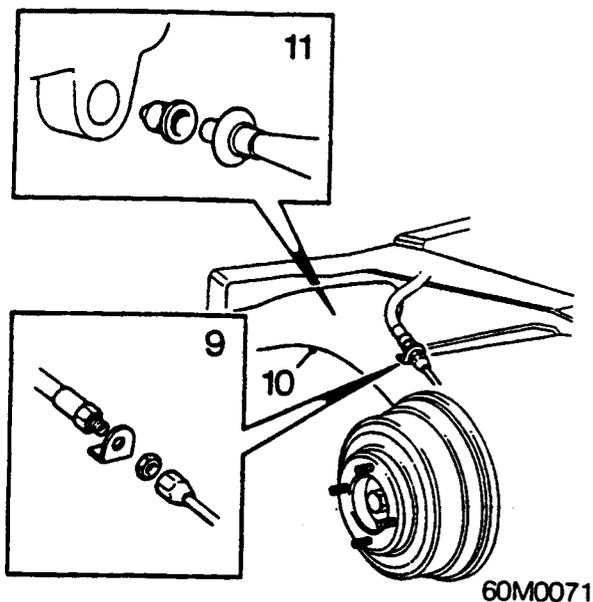

9. Disconnect brake hose from radius arm bracket.

CAUTION: Plug the connections.

10. Remove the support and lower the radius arm.

Do not carry out further dismantling if component is removed for access only

11. Lever the strut from rubber cone, remove strut and knuckle joint assembly.

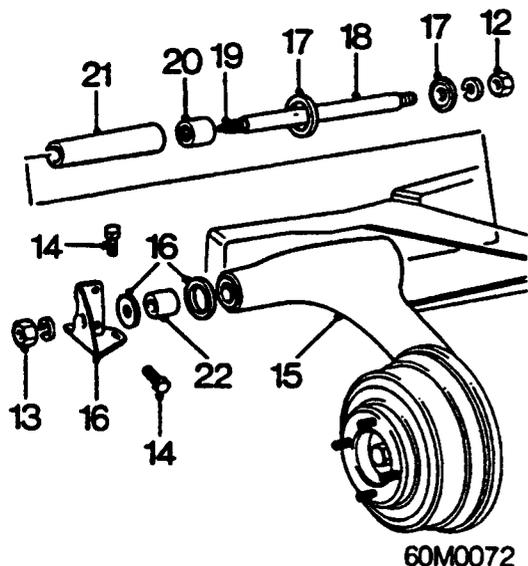

12. Remove inner nut and spring washer securing pivot shaft to sub - frame.
13. Remove outer nut and spring washer securing pivot shaft to bracket.
14. Remove 4 bolts securing bracket to sub - frame.
15. Remove radius arm assembly.
16. Remove bracket, small thrust washer and seal from outside face of radius arm.
17. Remove large thrust washer and seal from inside face of radius arm.
18. Pull pivot shaft from radius arm.
19. Unscrew grease nipple from shaft.

20. Using tools 18G 583 and 18G 583B pull needle roller bearing from inner end of arm.
21. Extract lubrication tube.
22. Using tool 18G 583 pull outer bronze bush from arm.

Refit

1. Using tools 18G 584, 18G 588 and 18G 588A fit bronze bush.
2. Fit lubrication tube.
3. Using tool 18G 620 fit needle roller bearing.
4. Using tool 18G 583 fit outer bronze bush.

Note: Lubricate bush and bearing.

5. Fit grease nipple to pivot shaft and fit to radius arm.
6. Fit thrust washers and dust shields

Note: Lubrication groove towards radius arm.

7. Position radius arm to sub - frame.
8. Fit pivot shaft bracket and tighten bolts.
9. Fit inner and outer spring washers and nuts to pivot shaft, tighten nuts to 72Nm.
10. Fit strut and knuckle joint assembly.
11. Connect brake hose to radius arm bracket.
12. Position handbrake cable quadrant to radius arm, fit clevis pin and secure with split pin.
13. Connect brake pipe union to brake back plate.
14. Connect handbrake cable to brake lever.
15. Fit rear damper.
16. Fit road wheel and tighten nuts 60 Nm.
17. Remove stand(s) and lower vehicle.



FRONT SUB - FRAME MOUNTING - FRONT

Service Repair No. 68.40.02.

Remove

1. Raise front of vehicle, one side.

WARNING: Support on safety stands.

2. Position jack to support sub - frame on side to be released.

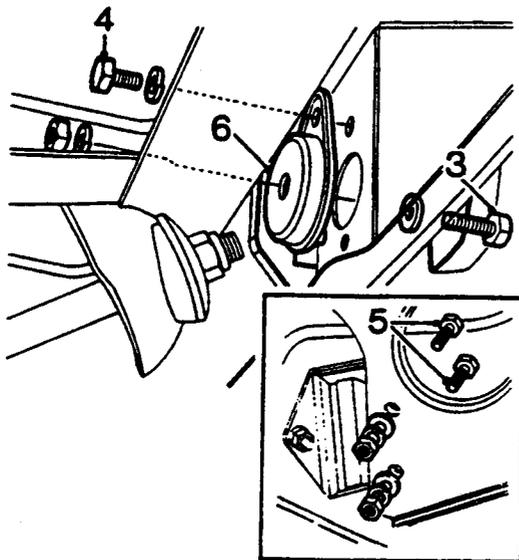

60M0073

3. Remove bolt securing front mounting to sub - frame.
4. Remove bolt securing front mounting bracket to body.
5. Remove 2 bolts securing rear mounting to sub - frame.
6. Lower sub - frame and remove front mounting.

Refit

1. Fit and tighten rear mounting bolts to 25Nm.
2. Fit bolt securing front mounting to body.
3. Raise jack to align sub - frame with mounting.
4. Fit bolt securing front mounting to sub - frame.
5. Remove stand(s) and lower vehicle.

FRONT SUB - FRAME MOUNTING - REAR

Service Repair No. 68.40.03

Remove

1. Raise front of vehicle, one side.

WARNING: Support on safety stands.

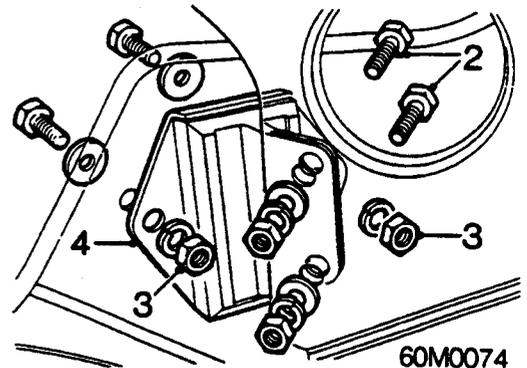

60M0074

2. Remove 2 bolts securing rear mounting to sub - frame.
3. From inside car, pull back carpet and remove 2 nuts and spring washers securing rear mounting to body.
4. Remove rear mounting.

Refit

1. Position rear mounting.
2. Fit nuts and spring washers securing rear mounting to body.
3. Fit and tighten rear mounting to sub - frame bolts to 25Nm.
4. Remove stand(s) and lower vehicle.

SUSPENSION

REAR SUB - FRAME MOUNTING - FRONT

Service Repair No. 68.40.08.

Remove

1. Raise rear of vehicle, one side.

WARNING: Support on safety stands.

2. Remove radius arm assembly, see **Radius arm pivot bearings**.

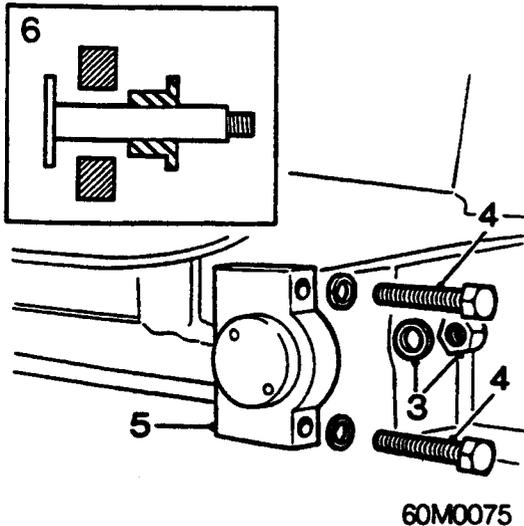

3. Remove locknut and plain washer securing support pin to sub - frame.
4. Remove 2 bolts securing trunnion to body.
5. Lever sub - frame downwards and remove trunnion assembly.
6. Withdraw the support pin and extract bushes from trunnion.

Refit

1. Fit bushes to trunnion.
2. Fit support pin to trunnion assembly.
3. Fit bolts, trunnion to body.

Note: The step in trunnion and the short trunnion to body bolt are at the top.

4. Fit locknut and plain washer securing support pin to sub - frame.
5. Refit radius arm assembly, see **Radius arm pivot bearings**.
6. Remove stand(s) and lower vehicle.

REAR SUB - FRAME MOUNTING - REAR

Service Repair No. 68.40.09.

Remove

1. Raise rear of vehicle, one side.

WARNING: Support on safety stands.

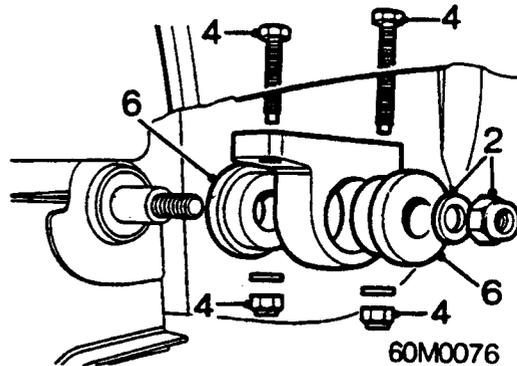

2. Remove locknut and plain washer securing trunnion to sub - frame.
3. *Left hand mounting:* Remove fuel tank, see **FUEL DELIVERY SYSTEM**.
4. Remove 2 locknuts, plain washers and bolts securing trunnion to body floor.
5. Lever sub - frame away from body and remove trunnion assembly.
6. Extract bushes from trunnion.

Refit

1. Fit bushes to trunnion.
2. Fit nuts and bolts, trunnion to body floor.

Note: The step in trunnion and short trunnion to body bolt are at the front.

3. Fit locknut and plain washer securing trunnion to sub - frame.
4. *Left hand mounting:* Refit fuel tank, see **FUEL DELIVERY SYSTEM**.
5. Remove stand(s) and lower vehicle.

BRAKES

CONTENTS

Repairs	Page
Brake system - bleed	2
Front brake pads	3
Front brake caliper	3
Front brake caliper overhaul	4
Front brake disc	5
Front dust shield	6
Rear brake drum	6
Rear brake shoes	7
Rear wheel cylinder	8
Rear wheel cylinder overhaul	8
Rear brake backplate	8
Brake pedal	9
Brake servo	10
Brake master cylinder	11
Brake master cylinder overhaul	12
Handbrake cable	14
Pressure reducing valve	16



BRAKES

BRAKE SYSTEM - BLEED

Service Repair No.

Complete system - 70.25.02

Front brakes - 70.25.04

Rear brakes - 70.25.05

Note: The following procedure covers bleeding the complete hydraulic system but where only the front or rear systems have been disturbed in isolation, it should only be necessary to bleed that system. Partial bleeding of the hydraulic system is only permissible if a brake pipe or hose has been disconnected with only a minor fluid loss.

CAUTION: Never re-use fluid that has been bled from the system. Do not allow the fluid level to fall so low that air can enter the system during bleeding. Check reservoir fluid level frequently during bleeding operation and top-up as necessary. Do not fill above the MAX mark.

CAUTION: Do not allow brake fluid to contact paint finished surfaces as paint may be damaged. If spilled, remove fluid and clean area with clean, warm water.

WARNING: Absolute cleanliness must be maintained, do not allow dirt or foreign liquids to enter reservoir when topping-up.

Use only AP Premium Super DOT 4 or Castrol Girling Universal DOT 4 brake fluid from airtight containers.

Bleed

1. Raise front and rear of vehicle.

WARNING: Support on safety stands.

2. Adjust rear brakes, see **MAINTENANCE**.
3. Check that all pipe and hose connections are tight and bleed screws are closed.
4. Top up the master cylinder reservoir with recommended brake fluid, see **INFORMATION - CAPACITIES, FLUIDS AND LUBRICANTS**.

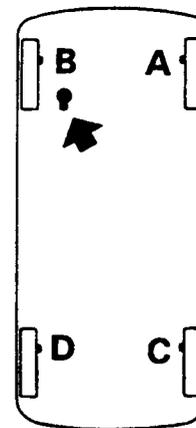
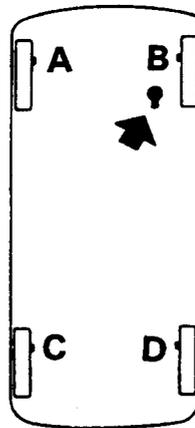

70M0348

RH Drive

LH Drive

5. Connect bleed tube to front bleed screw A and submerge end in a transparent container containing clean brake fluid. Start bleeding the system working round the vehicle in sequence shown - A, B, C and D.
6. Open bleed screw three-quarters of a turn.
7. Depress brake pedal through its full stroke, keep pedal depressed for a few seconds then release pedal allowing it to return unassisted.
8. Repeat this action until a flow of clean, air free fluid is obtained. Use an assistant to tighten the bleed screw to 9 Nm at the end of a downward stroke.
9. Repeat the procedure at each bleed screw in turn.

CAUTION: Ensure that the fluid level is maintained during bleeding by topping up with new brake fluid.

10. Apply working pressure to the brake pedal for two minutes during which time examine the entire system for leaks and that brake pedal travel does not increase.
11. Top-up fluid in master cylinder reservoir to correct level, fit filler cap.
12. Drive the vehicle and test the brakes. Pedal travel should be short and feel solid with no indication of sponginess.



FRONT BRAKE PADS

Service Repair No. 70.40.02

Remove

WARNING: Brake pads must be renewed in axle sets only. Braking efficiency may otherwise be impaired.

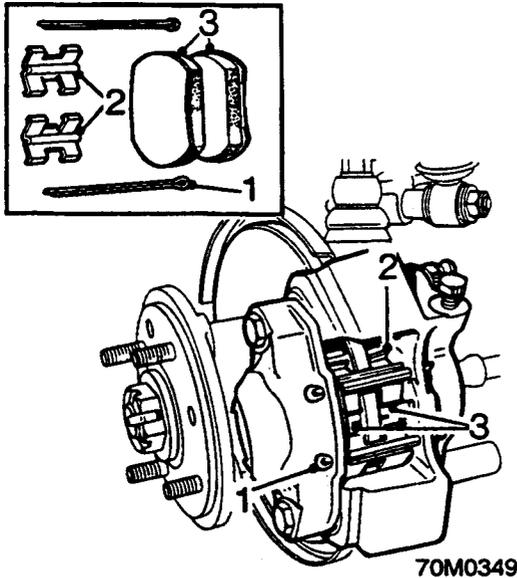

1. Remove split pins.
2. Remove anti - rattle springs.
3. Extract brake pads from calipers.
4. Clean the dust from calipers.

WARNING: Do not use an airline to blow lining dust, asbestos dust can be a serious health hazard if inhaled. Use brake cleaning fluid or industrial alcohol.

5. Ensure that the piston dust covers are in good condition.
6. Examine caliper for signs of hydraulic leakage; rectify as necessary.
7. Rotate brake disc by hand, remove all scale and rust from around the edge of the disc with a scraper.
8. Scrape the pad locating surfaces in the caliper free of rust.

Refit

1. Remove filler cap from master cylinder reservoir.
2. Position clean cloth around filler neck to absorb displaced fluid.
3. Using tool 18G 590, press the pistons back into their bores.
4. Fit pads.
5. Fit anti - rattle springs.
6. Fit split pins.
7. Depress footbrake several times to give correct pad to disc clearance.
8. Check/top - up fluid level in reservoir, fit filler cap.
9. Fit road wheels and tighten nuts to 60 Nm

10. Remove stand(s) and lower vehicle.

FRONT BRAKE CALIPER

Service Repair No. 70.55.02

Remove

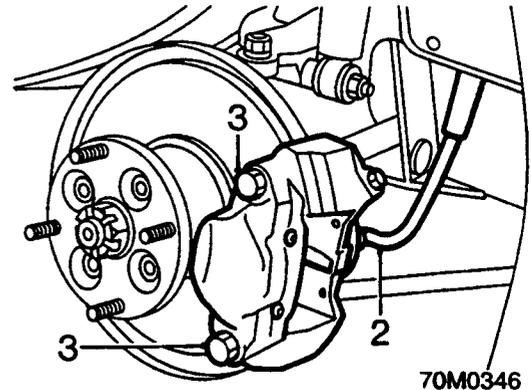

WARNING: Do not use an airline to blow lining dust, asbestos dust can be a serious health hazard if inhaled. Use brake cleaning fluid or industrial alcohol.

1. Remove brake pads, see Front brake pads.
2. Disconnect front hose from brake pipe.

CAUTION: Plug the connections.

3. Remove 2 retaining bolts and lift the caliper from the swivel hub.

Refit

1. Position caliper to swivel hub, fit bolts and tighten to 52 Nm.
2. Connect front hose to brake pipe.

CAUTION: Do not overtighten union.

3. Fit brake pads, Front brake pads.
4. Fit road wheels and tighten nuts to 60 Nm.
5. Bleed braking system, see Brake system - bleed.

BRAKES

FRONT BRAKE CALIPER OVERHAUL

Service Repair No. 70.55.13

Dismantle

WARNING: Do not use an airline to blow lining dust, asbestos dust can be a serious health hazard if inhaled. Use brake cleaning fluid or industrial alcohol.

1. Remove brake pads, see Front brake pads.

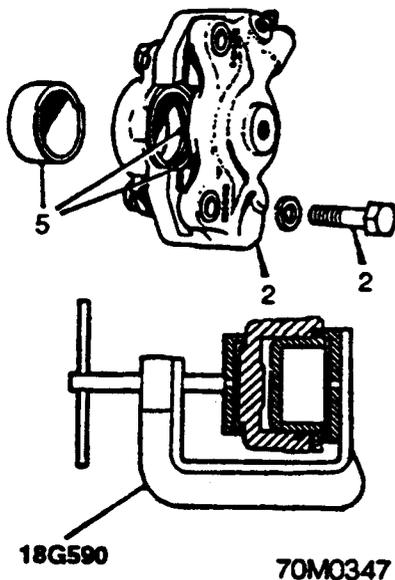

2. Remove 2 bolts, remove caliper from swivel hub.

CAUTION: Do not allow weight of caliper to hang on brake hose.

3. Retain inner piston using tool 18G 590.
4. Apply brake pedal gently to force outer piston almost from its bore.
5. Withdraw piston, dust seal and fluid seal; discard seals.

Inspection

6. Check caliper bore and piston, if scored or showing signs of wear, renew caliper assembly.

Assembly

WARNING: Absolute cleanliness must be observed at all times. Use only clean brake fluid for cleaning internal components. Lubricate all components with brake fluid prior to assembly.

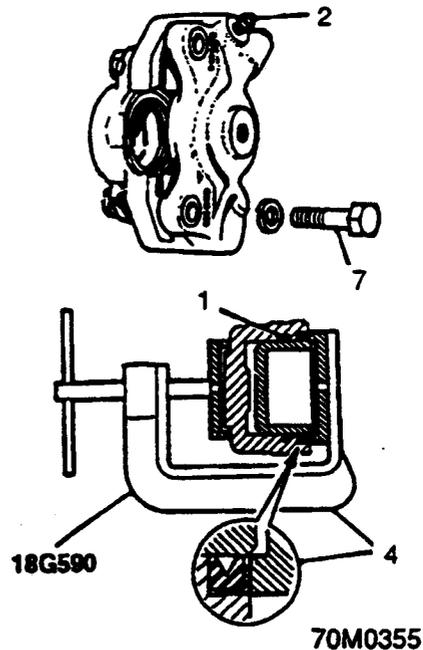

1. Lubricate new seals with brake fluid, and fit the piston seal.
2. Slacken bleed screw.
3. Lubricate the piston with brake fluid and insert it into the bore with the cut - away at the top. Press the piston in using tool 18G 590 until 8 mm (0.32 in) remains protruding.
4. Fit a new dust seal into the retainer part of tool 18G 590, fit the seal and retainer onto the piston. Press the piston and seal into the caliper.
5. Tighten bleed screw.
6. Repeat above procedure for the other piston.
7. Position caliper to swivel hub, fit bolts and tighten to 52 Nm.
8. Fit brake pads, see Front brake pads.
9. Bleed braking system, see Brake system - bleed.



FRONT BRAKE DISC

Service Repair No. 70.10.10

Remove

1. Raise front of vehicle, one side.

WARNING: Support on safety stands.

2. Remove road wheel(s).
3. Remove 2 bolts securing caliper and support caliper.

CAUTION: Do not allow weight of caliper to hang on brake hose.

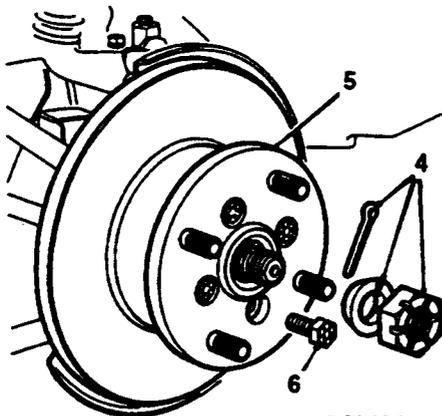

70M0343

4. Remove split pin and discard. Remove drive shaft nut and split collar.
5. Pull drive flange and disc assembly from the drive shaft.
6. Hold disc assembly in a vice and remove 4 bolts securing drive flange to brake disc.
7. Separate drive flange from brake disc.

Refit

1. Clean mating surfaces of drive flange and brake disc.
2. If necessary, apply recommended grease to hub bearings; see **INFORMATION - CAPACITIES, FLUIDS AND LUBRICANTS.**
3. Fit brake disc to drive flange and tighten bolts to 57 Nm.
4. Fit drive flange and disc assembly to drive shaft.

CAUTION: The following operation must be carried out to ensure correct seating of the drive flange.

5. Fit a suitably sized plain washer to drive shaft, fit hub nut and tighten to 260 Nm.

CAUTION: Rotate hub as nut is tightened to settle bearings.

6. Remove hub nut and discard plain washer.
7. Fit the split collar and hub nut; tighten hub nut to 260 Nm.

CAUTION: Rotate hub as nut is tightened to settle

bearings.

Note: Do not fit split pin at this stage.

8. Attach a magnetic base dial gauge to caliper mounting lug on swivel hub and check disc run - out.

Disc run - out = 0.05 mm.

Note: If disc run - out is excessive, either reposition disc on drive flange or reposition disc and drive flange assembly on drive shaft, then re - check disc run - out.

9. Remove dial gauge.

10. Fit new split pin to secure hub nut

Note: If necessary, tighten nut to align to next split pin hole.

11. Fit caliper and tighten bolts to 52 Nm.
12. Fit road wheel and tighten nuts to 60 Nm
13. Remove stand(s) and lower vehicle.

BRAKES

FRONT DUST SHIELD

Service Repair No. 70.10 18.

Remove

1. Raise front of vehicle, one side.

WARNING: Support on safety stands.

2. Remove road wheel(s).

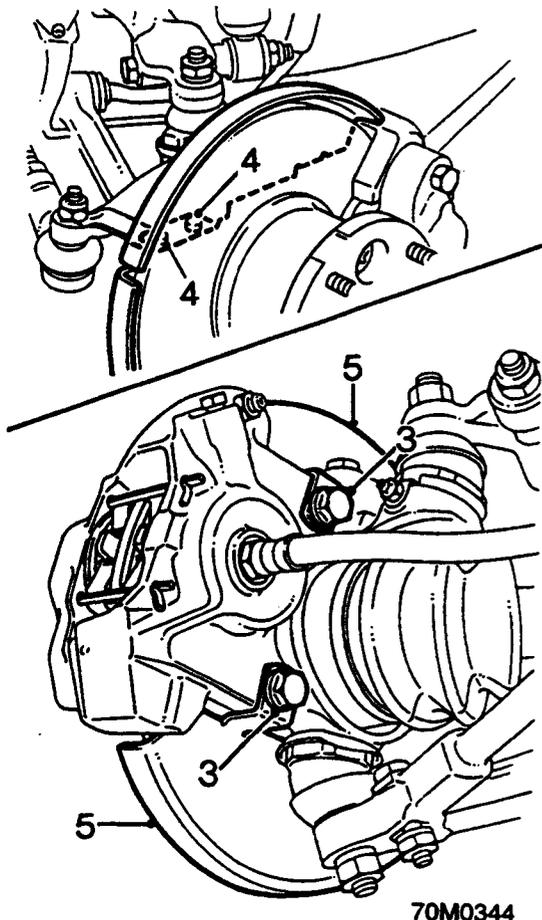

3. Remove the caliper securing bolts, support caliper.
4. Remove screws retaining two halves of the dust shield.
5. Remove dust shield.

Refit

1. Fit dust shield, position steering arm bracket.
2. Fit screws retaining two halves of the dust shield.
3. Fit caliper and tighten bolts to 52 Nm.
4. Fit road wheel and tighten nuts to 60 Nm.
5. Remove stand(s) and lower vehicle.

REAR BRAKE DRUM

Service Repair No. 70.10.03.

Remove

1. Release handbrake.
2. Raise rear of vehicle, one side.

WARNING: Support on safety stands.

3. Remove road wheel(s).

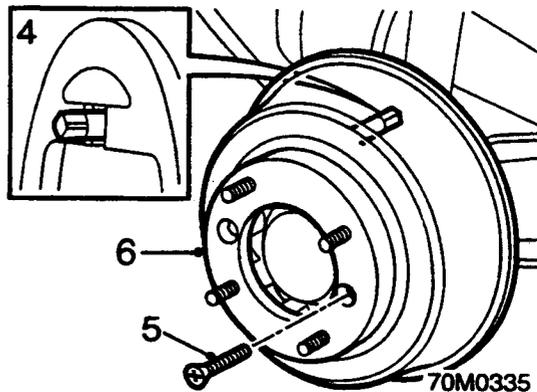

4. Slacken brake shoe adjuster.
5. Remove brake drum securing screw.
6. Withdraw brake drum from hub.
7. Wash all brake dust from back plate and drum.

WARNING: Do not use an airline to blow lining dust, asbestos dust can be a serious health hazard if inhaled. Use brake cleaning fluid or industrial alcohol.

Refit

1. Fit brake drum to hub and tighten securing screw.
2. Fit road wheel and tighten nuts to 60 Nm
3. Adjust rear brakes, see **MAINTENANCE**.
4. Remove stand(s) and lower vehicle. -



REAR BRAKE SHOES

Service Repair No. 70.40.03

Renew

WARNING: Brake shoes must be replaced in axle sets only. Braking efficiency may otherwise be impaired.

1. Remove rear brake drums, see **Rear brake drum**.

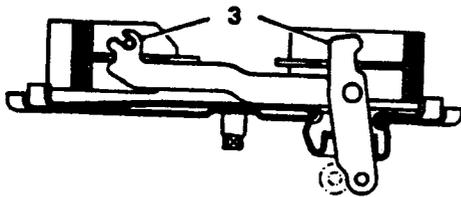
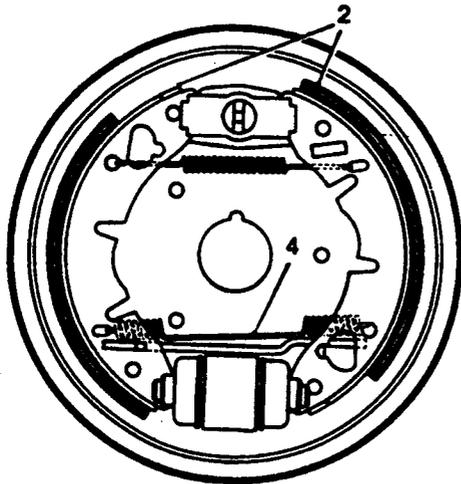

70M0350

2. Release brake shoes from adjuster and then from wheel cylinder.
3. Disengage handbrake levers and remove brake shoes; recover pull-off springs.
4. Position shoes and fit the bottom pull-off spring ensuring the connecting wire is to the bottom.
5. Locate handbrake levers and fit brake shoes onto the wheel cylinder.
6. Fit top pull-off spring and lift brake shoes onto the adjuster.
7. Fit rear brake drums, see **Rear brake drum**.
8. Adjust rear brakes, see **MAINTENANCE**.

REAR WHEEL CYLINDER

Service Repair No. 70.60.18

Remove

1. Remove rear brake shoes, see **Rear brake shoes**.
2. Slacken brake pipe where it connects to the brake hose.

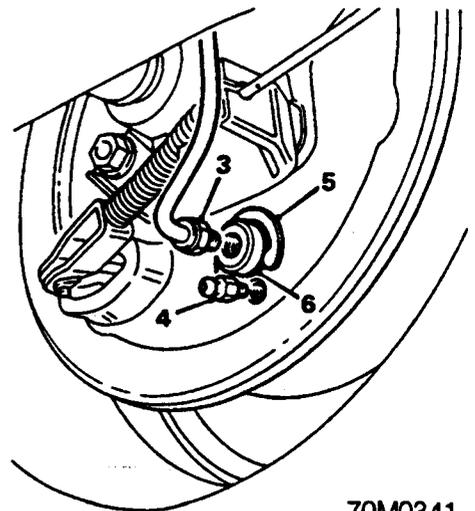

70M0341

3. Disconnect brake pipe from wheel cylinder.

CAUTION: Plug the connections.

4. Remove bleed screw.
5. Remove circlip retaining the wheel cylinder and discard.
6. Remove wheel cylinder and gasket; discard gasket.

Refit

1. Position wheel cylinder and new gasket to brake backplate, retain cylinder using a new circlip.
 2. Fit, but do not tighten bleed screw.
 3. Connect brake pipe to wheel cylinder and tighten union.
 4. Tighten brake pipe to brake hose union.
- CAUTION:** Do not overtighten the unions.
5. Fit rear brake shoes, see **Rear brake shoes**.
 6. Bleed braking system, see **Brake system bleeding**.

BRAKES

REAR WHEEL CYLINDER OVERHAUL

Service Repair No. 70.60.26

Dismantle

1. Remove wheel cylinder, see Rear wheel cylinder.

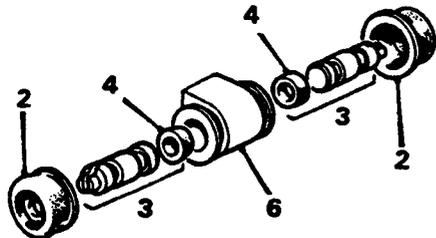

2. Remove 2 dust covers from wheel cylinder.
3. Withdraw 2 pistons.
4. Remove and discard seals from pistons.

Inspect

5. Clean all components in brake cleaning fluid or denatured alcohol.
6. Examine wheel cylinder bore and piston; if scored or damaged renew assembly.

Assemble

WARNING: Absolute cleanliness must be observed at all times. Use only clean brake fluid for cleaning internal components. Lubricate all components with clean brake fluid prior to assembly and assemble using the fingers only.

1. Fit new seals to pistons.
2. Insert pistons into wheel cylinder bore and fit dust covers.
3. Press pistons fully into wheel cylinder bore.
4. Fit wheel cylinder, see Rear wheel cylinder.

REAR BRAKE BACKPLATE

Service Repair No. 70.10.26.

Remove

1. Remove the brake shoes, see Rear brake shoes.

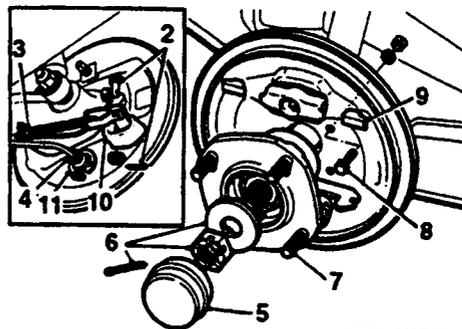

2. Remove and discard split pin from handbrake clevis pin. Remove clevis pin and disconnect handbrake cable.
3. Release handbrake cable from abutment bracket.
4. Disconnect brake pipe union from wheel cylinder.

CAUTION: Plug the connections.

5. Remove grease retaining cap from the hub.
6. Remove hub nut split pin and discard. Remove hub nut.
7. Using tools 18G 304 and 18G 304F remove hub.
8. Remove 3 bolts securing backplate and remove backplate.

Do not carry out further dismantling if component is removed for access only

9. Remove brake shoe adjuster wedges.
10. Remove handbrake lever shield.
11. Remove circlip retaining wheel cylinder to backplate, remove wheel cylinder and discard circlip and gasket.

Refit

1. Fit wheel cylinder and new gasket to backplate, secure with new circlip.
2. Fit handbrake lever shield and brake shoe adjuster wedges to backplate.
3. Fit backplate and tighten bolts to 28 Nm.
4. If necessary, apply recommended grease to hub bearings, see **INFORMATION - CAPACITIES, FLUIDS AND LUBRICANTS**.
5. Fit rear hub and tighten nut to 81 Nm.

CAUTION: Rotate hub as nut is tightened to settle bearings. If necessary, tighten nut to align to next split pin hole.

6. Fit new split pin.
7. Fit grease retaining cap.



8. Connect brake pipe union to wheel cylinder and tighten.
9. Fit handbrake cable to the abutment bracket.
10. Position handbrake cable to handbrake lever.
11. Fit new split pin and clevis pin to secure handbrake cable.
12. Fit brake shoes, see **Rear brake shoes**.

BRAKE PEDAL

Service Repair No. 70.35.01

Remove

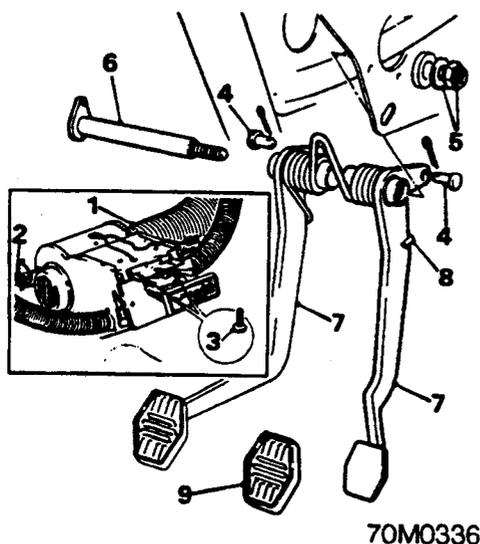

1. Disconnect air intake tube from between the heater and wheel arch duct.
2. Slacken, but do not remove nut securing the rear of the heater to body.
3. Remove 2 screws securing front of heater unit to the fascia and lower the assembly.
4. Remove and discard split pins from brake and clutch pedal clevis pins. Remove clevis pins from pedal.
5. Remove pedal shaft retaining nut and washer.
6. Withdraw pedal shaft.
7. Remove brake and clutch pedals from the pedal bracket.
8. Detach pedal return spring.
9. Remove pedal rubbers.

Do not carry out further dismantling if component is removed for access only

10. Check pedal shaft bushes for wear, replace if necessary.

CAUTION: Bushes must be replaced in pairs.

11. Using a hand press and suitable mandrel, press bushes out of pedal tube; discard bushes.

12. Using a hand press and suitable mandrel, press new bush into each end of pedal tube.
- Note:** End of each bush must be just below end face of pedal tube.
13. Check that pedal shaft is free to rotate in bushes.

Refit

1. Lightly oil pedal shaft.
2. Fit new pedal rubbers.
3. Position pedal return spring to pedals ensuring ends of spring are fully engaged.
4. Position brake and clutch pedals to pedal bracket ensuring cranked portion of pedal return spring is located in bracket.
5. Fit pedal shaft, fit washer and retaining nut; tighten nut.
6. Position brake and clutch push rods to pedals, fit clevis pins and secure with new split pins.
7. Raise heater unit to its fitted position, fit and tighten 2 screws.
8. Tighten heater securing nut.
9. Connect air intake tube to heater and wheel arch duct.

BRAKES

BRAKE SERVO

Service Repair No. 70.50.01

Remove

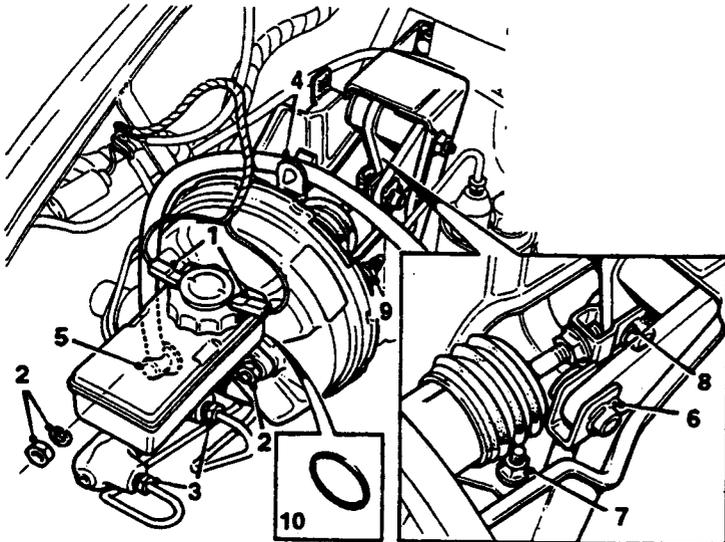

70M0337

1. Disconnect 2 Lucars from the brake fluid reservoir filler cap.
2. Remove 2 nuts and washers securing the master cylinder to the servo.
3. Position absorbent cloth around master cylinder brake pipe unions, slacken the brake pipe union nuts and withdraw the master cylinder from servo. Immediately tighten the union nuts to prevent excess loss of fluid.
4. Release servo hose from retaining clip on bracket.
5. Release servo hose adaptor from servo.
6. Remove and discard split pin from brake push rod clevis pin. Remove clevis pin securing brake push rod to fulcrum.
7. Remove 3 nuts, bolts and washers securing the servo mounting bracket to body. Remove the servo and bracket assembly.
8. Remove and discard split pin from the servo push rod clevis pin. Remove clevis pin securing servo push rod to fulcrum.
9. Remove 4 nuts and washers securing servo to mounting bracket. Remove brake servo.
10. Remove and discard 'O' ring from master cylinder.

Refit

1. Lubricate a new 'O' ring with brake fluid and fit to master cylinder.
2. Lubricate master cylinder push rod with brake fluid.
3. Position servo to mounting bracket, fit washers and nuts; tighten nuts to 25 Nm.
4. Align servo push rod to fulcrum bracket, fit clevis pin and secure with new split pin.
5. Position servo and mounting bracket to body. Align brake pedal push rod to fulcrum, fit clevis pin and secure with new split pin.
6. Fit servo bracket to body retaining nuts and bolts and tighten to 25 Nm.
7. Connect servo hose adaptor to servo and secure clip to bracket.
8. Slacken brake pipes to master cylinder union nuts.
9. Position master cylinder to servo ensuring push rod is correctly located, fit nuts and tighten to 15 Nm.
10. Tighten brake pipe union nuts to 15 Nm.
11. Bleed braking system, see **Brake system bleed**.



BRAKE MASTER CYLINDER

Service Repair No. 70.30.08

Remove

1. Attach a bleed tube to the front and rear brake bleed screws: -
LH Steering - Left hand side of car
RH Steering - Right hand side of car.
2. Open bleed screws and operate brake pedal until master cylinder reservoir is empty.
3. Tighten bleed screws and discard the fluid drained from the system.

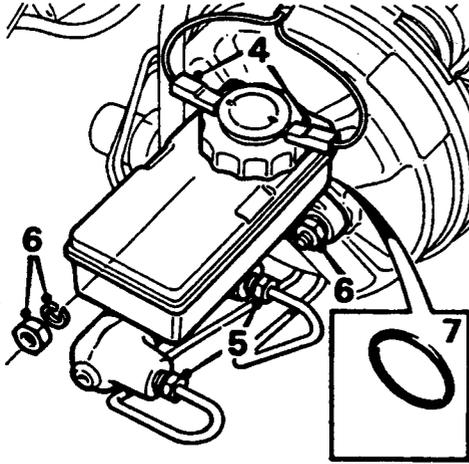

70M0352

4. Disconnect 2 Lucars from the brake fluid reservoir filler cap.
5. Disconnect 2 brake pipes from the master cylinder.

CAUTION: Plug the connections.

6. Remove 2 nuts and washers securing the master cylinder to the servo. Remove the master cylinder.
7. Remove and discard 'O' ring from master cylinder.

Refit

1. Smear new 'O' ring with clean brake fluid and fit to master cylinder.
2. Fit master cylinder to servo ensuring that push rod is correctly located. Fit nuts and washers and tighten to 15 Nm.
3. Connect brake pipes to master cylinder and tighten unions to 15 Nm.

CAUTION: Do not overtighten the unions.

4. Connect Lucars to reservoir filler cap.
5. Bleed the brake system, see **Brake system bleed**.
6. Check that the float mechanism is operating by depressing the plunger in the middle of the cap.
7. Release the handbrake. Switch on the ignition, unscrew the reservoir filler cap and raise the cap slightly. With the cap raised, check that the low fluid level warning light is illuminated.
8. Refit reservoir cap, switch off ignition and apply the handbrake.

BRAKES

BRAKE MASTER CYLINDER OVERHAUL

Service Repair No. 70.30.09

Dismantle

1. Remove master cylinder, see **Brake master cylinder**.
2. Drain any surplus brake fluid from reservoir and refit cap.

3. Plug pipe connections and thoroughly clean the exterior of master cylinder – use industrial alcohol or brake cleaning fluid.
4. Grip the cylinder body in a soft jawed vice with the reservoir uppermost.

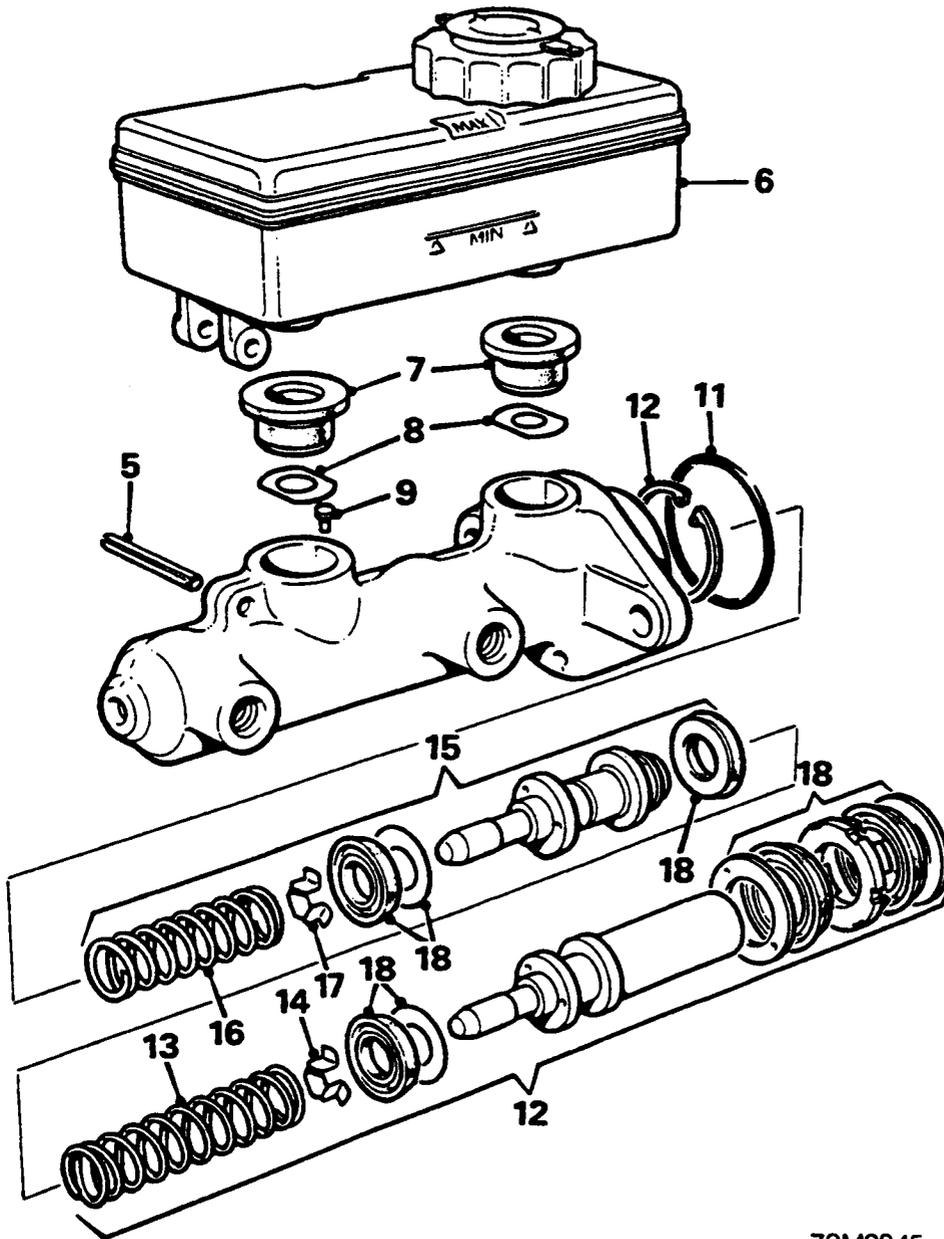

70M0345

5. Using a suitably sized, flat ended punch, drive out the roll pin securing the reservoir to the cylinder body.
6. Remove reservoir from master cylinder.
7. Remove 2 reservoir sealing washers.
8. Extract 2 metal seating washers.
9. Push the primary piston in as far as possible and using a pair of long nosed pliers, remove the secondary piston stop pin from the recess in the cylinder body.

10. Position the cylinder vertically in the vice with the primary piston uppermost.
11. Remove and discard the 'O' ring from the recess in the cylinder body.
12. Depress the primary piston and using tool 18G 1112, remove the circlip; withdraw the primary piston assembly and spring.
13. Remove the spring from the primary piston.
14. Carefully expand the spring retainer and slide it off the piston rod.



15. Apply low air pressure to the recess from where the secondary piston stop pin was removed and expel the secondary piston assembly and spring.
16. Remove the spring from the secondary piston.
17. Carefully expand the spring retainer and slide it off the piston rod.
18. Remove the rubber seals, washers and plastic bearing from the pistons.

Inspect

19. Clean all components with brake fluid and dry with lint free cloth.
20. Examine the cylinder bore – if scored or damaged, renew the assembly. Renew all seals, worn, damaged or suspect parts.

Assembly

CAUTION: *Thorough cleanliness must be observed during reassembly. Dip all components in clean brake fluid and assemble using fingers only.*

1. Fit new washers, new seals and plastic bearing to pistons.
2. Fit the spring retainers to primary and secondary pistons ensuring that each retainer is located behind the machined shoulder on the pistons.
3. Fit the springs to the retainers noting that the thicker of the two springs is attached to the secondary piston retainer.
4. Insert secondary piston assembly into cylinder bore taking care not to turn back the lip of piston seal.
5. Using a soft metal drift, push the secondary piston down the cylinder bore; hold the piston down and insert stop pin.
6. Insert primary piston assembly into cylinder bore; push the piston down and using tool **18G 1112**, fit circlip.
7. Fit metal seating washers in the cylinder recesses.
8. Fit reservoir sealing washers.
9. Fit brake fluid reservoir ensuring that the securing pin holes in the cylinder and reservoir are aligned.
10. Secure reservoir to master cylinder with roll pin.
11. Fit master cylinder, see **Brake master cylinder**.

BRAKES

HANDBRAKE CABLE

Service Repair No. Front cable - 76.35.14

Service Repair No. Rear cable - 76.35.15

Remove

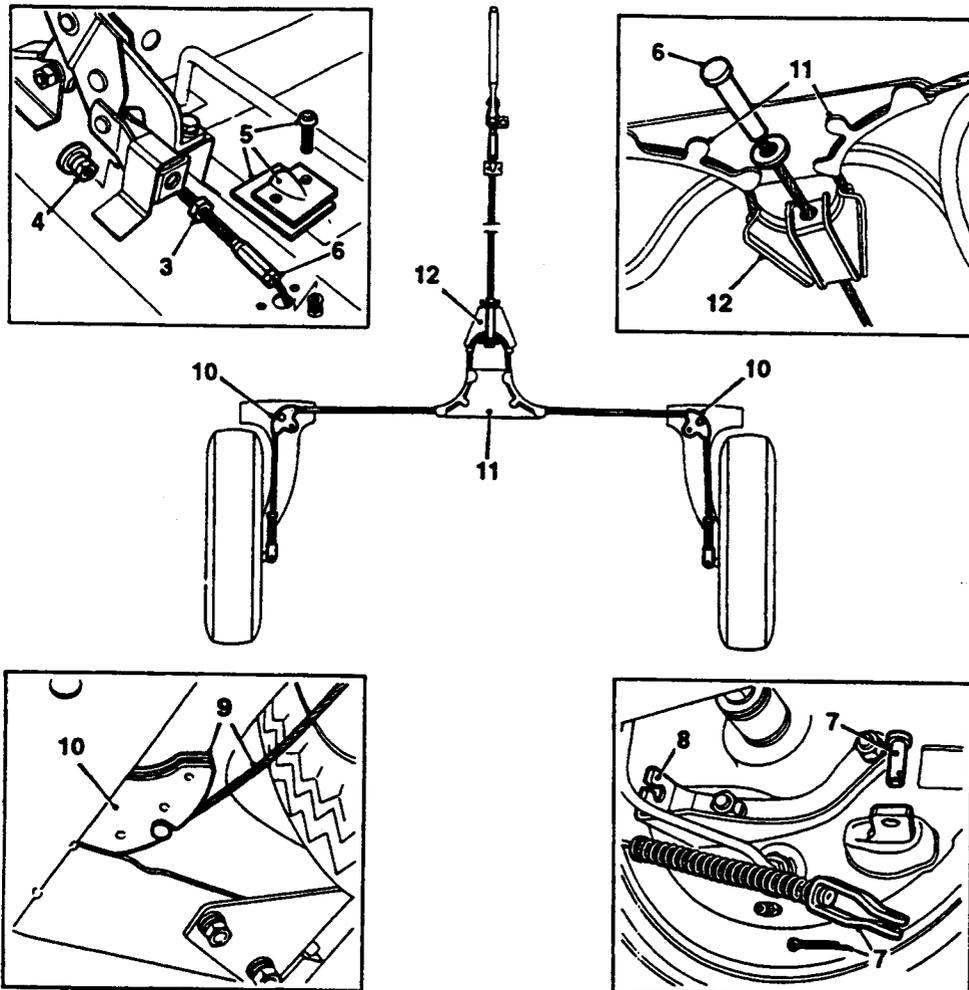

70M0339

CAUTION: It will be necessary to remove the front cable prior to removing the rear cable.

Front cable

1. Tilt both front seats forwards, fold back rear floor covering.
2. Raise front and rear of vehicle.

WARNING: Support on safety stands.

3. Slacken locknut.
4. Unscrew front cable adjusting nut, release cable from handbrake.
5. Remove screws securing front cable guide plate, remove guide plate, sealing pad and cable locknut.
6. Pull front cable through floor and disconnect cable from compensator assembly.

Rear cable

7. Remove and discard split pins from handbrake lever clevis pins. Remove clevis

pins and release rear cable from the handbrake levers.

8. Release rear cable from abutment brackets.
9. Lever back the flange at sector corners where it retains the rear cable.
10. Release rear cable from sectors.
11. Lever back retaining tags at sub-frame guide plate.
12. Remove rear cable and compensator assembly.

Refit

Rear cable

1. Position rear cable and compensator assembly.
2. Locate cable in sub-frame guide plate, lever up retaining tags.

CAUTION: Ensure cable is free to move in guide plate.



3. Locate cable in flange of each sector and compress flange to retain cable.

CAUTION: *Ensure cable is free to move in sector.*

4. Compress spring and locate cable in each abutment bracket.
5. Connect cable to each handbrake lever, fit clevis pins and secure with new split pins.

Front cable.

6. Thread front cable through compensator assembly.
7. Using assistance, thread cable through floor.
8. Fit sealing pad and cable guide plate, fit and tighten screws.
9. Fit cable locknut.
10. Position cable in handbrake, fit but do not tighten adjusting nut.
11. Adjust handbrake, see **MAINTENANCE**.

BRAKES

PRESSURE REDUCING VALVE

Service Repair No. 70.25.21

Remove

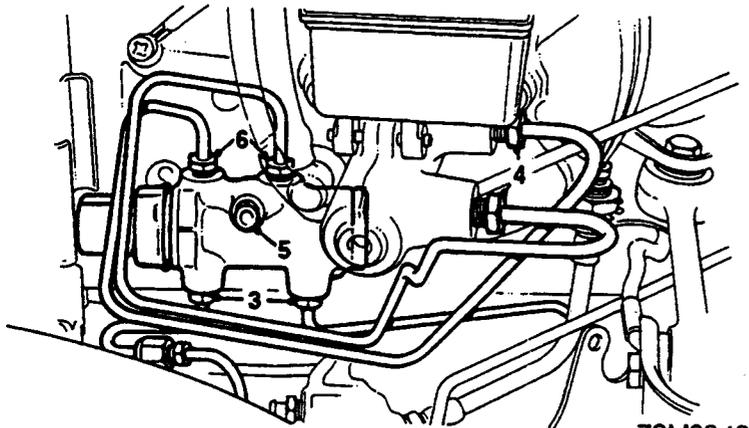

70M0340

1. Remove 2 screws securing ECU mounting bracket to valance and move aside.
2. Position absorbent cloth under pressure reducing valve unions.
3. Slacken unions and disconnect lower 2 brake pipes from pressure reducing valve.

CAUTION: Plug the connections.

4. Position absorbent cloth around master cylinder brake pipe unions, slacken and disconnect brake pipes from master cylinder.

CAUTION: Plug the connections.

5. Remove the bolt securing pressure reducing valve to body, remove the valve together with brake pipes.
6. Note the fitted position of the pipes connected to the top of the valve and with the valve held in a soft jawed vice, slacken and remove the pipes.

Refit

1. With the valve held in a soft jawed vice, connect the brake pipes to the top of the valve and tighten to 15 Nm.

CAUTION: Ensure that the pipes are in their correct fitted positions.

CAUTION: Do not over-tighten the unions.

2. Fit the valve ensuring that it is mounted horizontally, fit and tighten retaining bolt to 17 Nm.
3. Connect the brake pipes to the master cylinder and tighten to 15 Nm.

CAUTION: Do not overtighten the unions.

4. Connect the brake pipes beneath the valve.

CAUTION: Do not overtighten the unions.

5. Position ECU mounting bracket to valance and secure with screws.
6. Bleed braking system, see **Brake system bleed**.

BODY

CONTENTS

Repairs	Page
Bonnet	2
Bonnet lock	3
Bonnet release cable	3
Door assembly	5
Door trim capping	6
Door trim casing	6
Door lock	7
Door exterior handle and private lock	8
Door glass regulator	8
Door glass	9
Door lock striker plate	10
Luggage compartment lid	10
Luggage compartment lid handle and lock assembly	11
Luggage compartment lid private lock	11
Front grille	12
Front towing bracket	12
Windscreen	13
Rear window	14
Quarter vent glass	14
Rear quarter trim panel	15
Rear window components - Cabriolet	16
Rear quarter trim panel - Cabriolet	17
Rear quarter glass regulator - Cabriolet	17
Rear quarter glass - Cabriolet	18
Wooden fascia components	20
Wooden fascia	21
Glove box lid	23
Fascia top rail	23
Front carpet	24
Rear carpet - Cabriolet	24
Front seat - Saloon	25
Front seat - Cabriolet	25
Rear seat	26
Front seat belts - Saloon	27
Front seat belts - Cabriolet	27
Rear seat belt - Cabriolet	28
Body styling components	29
Lh front bumper	30
Rh front bumper	31
Front wheel arch finisher	32
Sill finisher	32
Rear wheel arch finisher	33
Lh rear bumper	34
Rh rear bumper	35



BODY

CONTENTS

Fabric sun roof components	36
Sun roof cover adjustment	37
Sun roof front seal	38
Wind deflector	38
Sun roof switch	39
Sun roof motor	39
Sun roof covers	40
Sun roof slide shoes	43
Sun roof drive cable	43
Sun roof cover seal	44
Sun roof	44
Cabriolet hood components	46
Hood catches	47
Hood handle	47
Header seal	48
Cantrail tensioning cable	48
Hood assembly	49
Hood frame	50
Hood cover	53



BODY

BONNET

Service Repair No. 76.16.01

Remove

1. Support the bonnet in the fully open position.
2. Fit protection covers to wings.

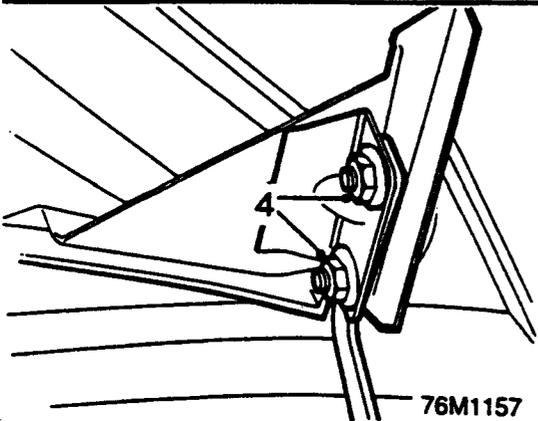
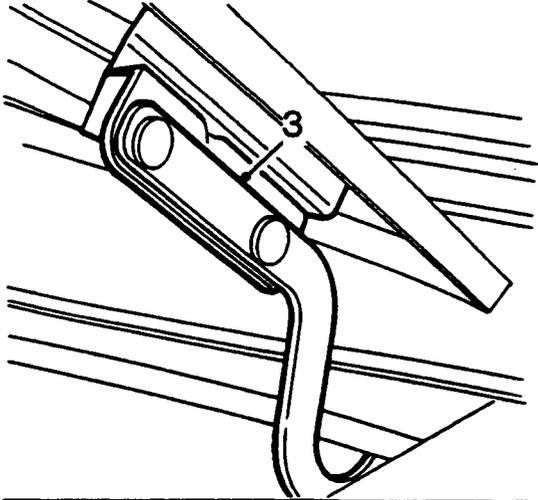

3. Mark hinge outlines on bonnet, if bonnet is to be refitted.
4. Using assistance, support bonnet, remove 4 nuts and washers securing bonnet to hinges; lift off bonnet.

Do not carry out further dismantling if component is removed for access only

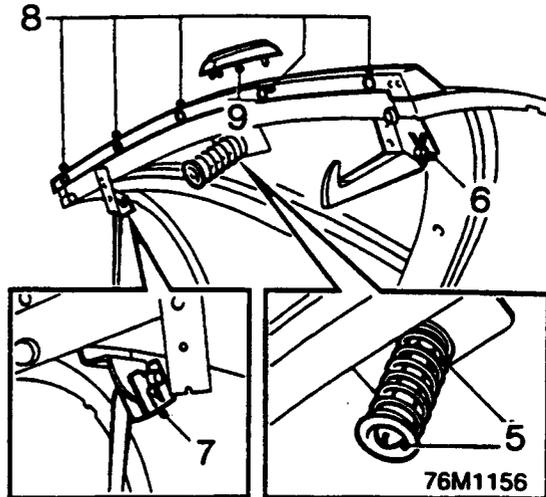

5. Slacken locknut and unscrew the locking pin assembly from bonnet mounting.
6. Remove split pin and clevis pin securing bonnet safety catch.
7. Remove bonnet stay retaining clip and remove stay.
8. Remove 5 screws securing finisher to bonnet and remove finisher.
9. Carefully remove badge from bonnet.
10. Fit badge to bonnet.
11. Fit bonnet stay to bonnet and secure with clip.
12. Fit finisher to bonnet and secure with screws.
13. Position safety catch to bonnet, fit clevis pin and secure with split pin.
14. Screw locking pin assembly to bonnet and tighten lock nut.

Refit

1. Using assistance, position bonnet on hinges.
2. *Existing bonnet:* Align hinge outlines.
3. *New bonnet:* Centralise bonnet on hinge studs.
4. Fit and lightly tighten 4 nuts, hinges to bonnet.

Adjust

1. Lower bonnet on to safety catch; adjust position of bonnet to equalise gaps to body.
2. Tighten hinge nuts to 10 Nm.
3. Close bonnet on to safety catch, check alignment.
4. Adjust bonnet lock as necessary, see **Bonnet lock**



BONNET LOCK

Service Repair No. 76.16.21

Remove

1. Open bonnet.

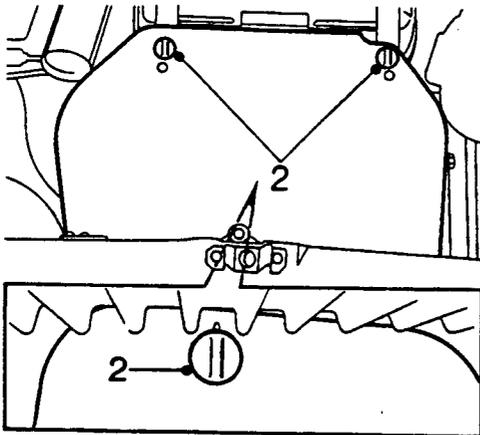

76M 0672

2. Release 3 turnbuckles and remove ignition splash shield.

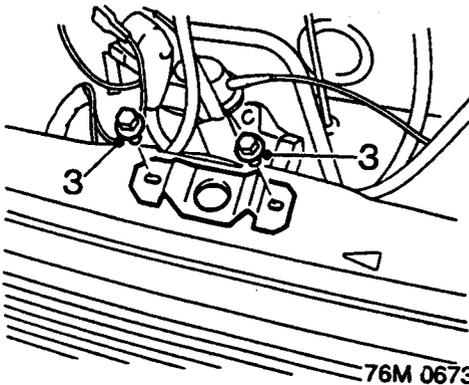

76M 0673

3. Remove 2 bolts securing bonnet lock to bonnet locking platform.

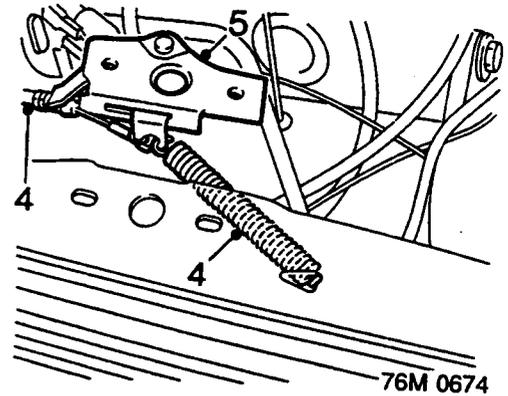

76M 0674

4. Disconnect return spring and cable from lock.
5. Remove lock.

Refit

1. Connect cable and return spring to lock.
2. Align lock to bonnet locking platform, fit but do not tighten 2 securing bolts.

Adjust

1. Close bonnet, aligning striker pin with lock.
2. Open bonnet, tighten 2 bolts to 10 Nm.
3. Close bonnet, check operation of bonnet catch.

BONNET RELEASE CABLE

Service Repair No. 76.16.29

Remove

1. Open bonnet.

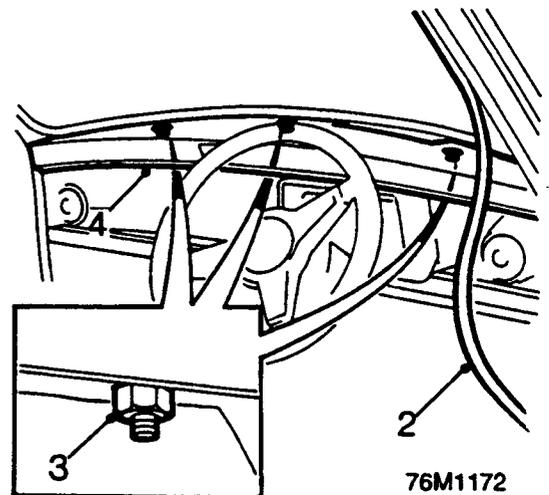

76M1172

2. Release 3 turnbuckles and remove ignition splash shield.

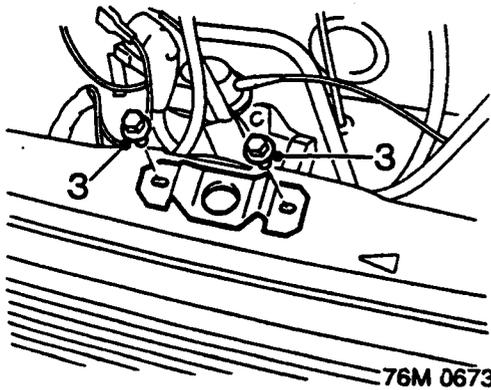

76M 0673

3. Remove 2 bolts securing bonnet lock to bonnet locking platform.

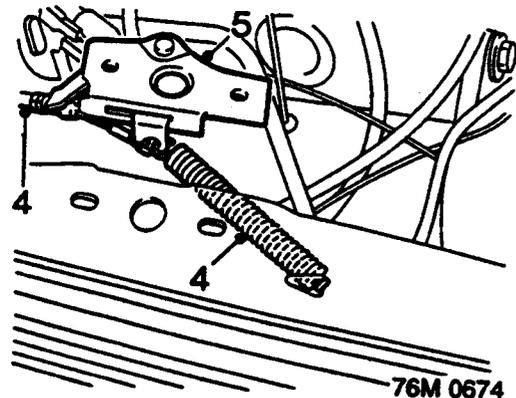

76M 0674

4. Disconnect return spring and cable from lock.
5. Remove lock.

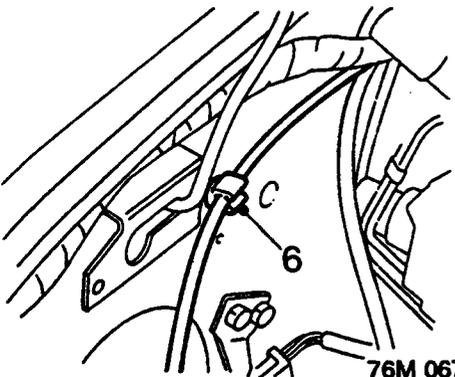

76M 0675

6. Release cable from clip on wing valance.

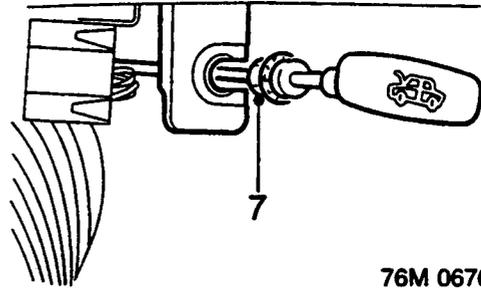

76M 0676

7. Slacken nut and release outer cable from bracket under fascia.

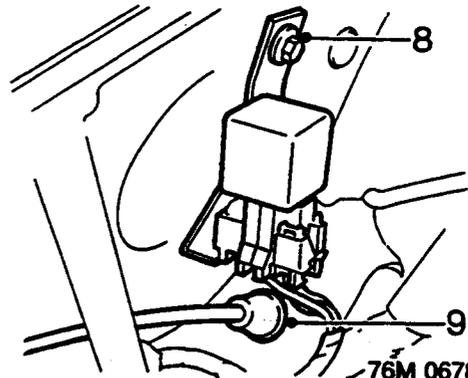

76M 0678

8. Remove bolt and release relay bracket from R.H. front wing valance to gain access to cable grommet.
9. Release cable grommet from bulkhead and withdraw cable from vehicle.

Refit

1. Remove grommet from new cable.
2. Feed new cable through hole in bulkhead into the engine compartment. If necessary use a wire hook to pull cable through bulkhead.
3. Fit grommet onto cable and secure to bulkhead.
4. Connect cable to bracket under fascia and tighten locknut.
5. Connect cable and return spring to lock.
6. Align lock to bonnet locking platform, fit but do not tighten 2 securing bolts.
7. Adjust lock and tighten bolts.
8. Fit ignition splash shield and secure with turnbuckles.
9. Secure cable to clip on wing valance.
10. Fit relay bracket to R.H. wing valance, fit and tighten bolt.
11. Close bonnet.



DOOR ASSEMBLY

Service Repair No.

Door remove and refit: 76.28.01

Door hinge remove and refit: 76.28.42

Remove

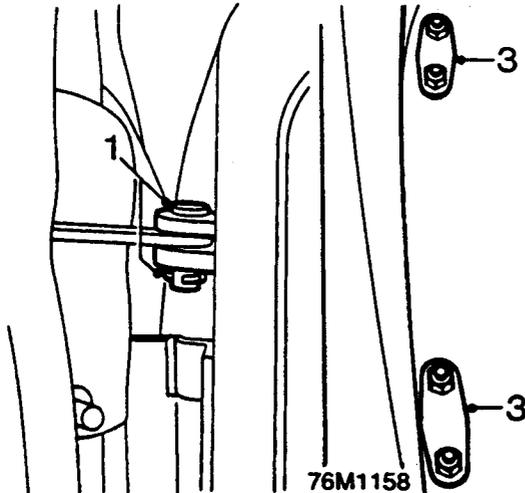

1. Remove the split pin and clevis pin from the door check strap.
2. Use assistance to support door.
3. Remove 4 nuts and 2 washer plates from the inside wheel arch.
4. Remove door assembly from body, noting the door alignment shims.

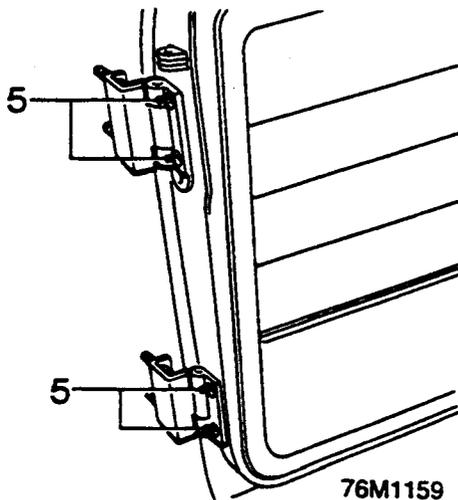

5. Remove 4 screws securing hinges to door and remove hinges.

Refit

1. Fit hinges to door and tighten screws.
2. Fit original shims to door.
3. Using assistance, position door to body.
4. Fit 2 washer plates and securing nuts but do not tighten.
5. Close door and check alignment of door in body aperture.
6. Adjust position of door; if the door to hinge adjustment is insufficient for correct door alignment, additional shims may be fitted between the hinges and the door.
7. Tighten door hinge to body nuts to 24 Nm.
8. Close door, and check alignment of door and adjust position of door lock striker if necessary, see **Door lock striker plate**.

DOOR TRIM CAPPING

Service Repair No. 76.34.15

Remove

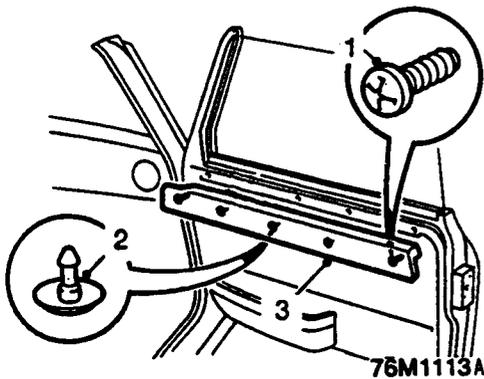

1. Remove 2 screws securing door capping to door.
2. Release 3 door capping securing studs from door.
3. Remove capping.

Note: If any studs break they must be replaced by removing the broken stud and glueing a new one in its place on the capping.

Refit

1. Position capping to door.
2. Push capping to secure studs to door.
3. Fit and tighten securing screws.

DOOR TRIM CASING

Service Repair No. 76.34.01

Remove

1. Open the door.

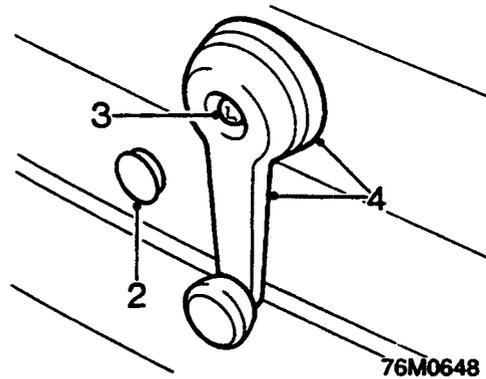

2. Remove cover from door glass regulator handle.
3. Remove screw securing door glass regulator handle to regulator.
4. Remove handle and escutcheon.

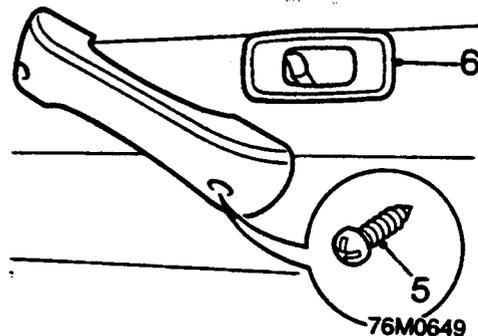

5. Remove 2 screws securing door pull and remove the door pull.
6. Remove door interior lock escutcheon.

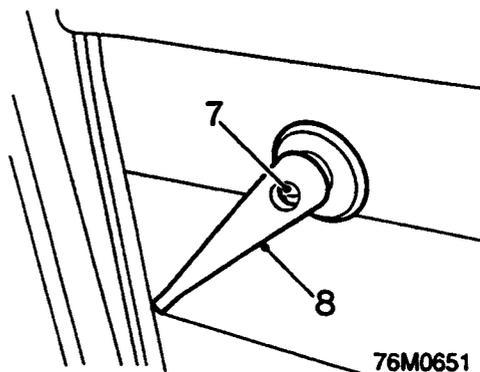

7. Remove screw securing door lock interior release handle.
8. Remove interior handle.

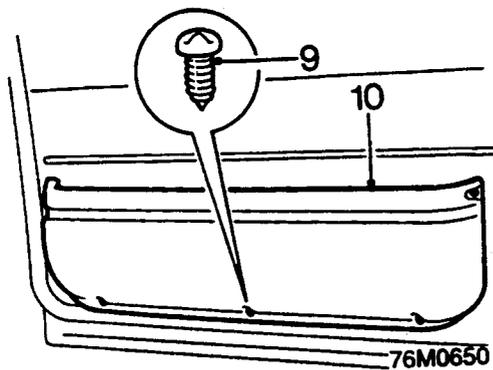

9. Remove 5 screws securing door pocket.
10. Remove door pocket.

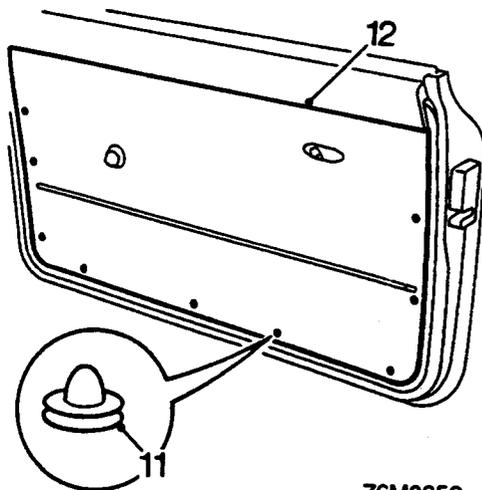

11. Release 9 trim casing retainers.
 12. Remove trim casing.
- Do not carry out further dismantling if component is removed for access only**
13. Transfer trim casing retainers to new trim casing.

Refit

1. Position trim casing to door and secure 9 retaining clips.
2. Align door pocket, fit and tighten 5 retaining screws.
3. Fit door lock interior release handle, fit and tighten screw.
4. Fit door interior lock escutcheon.
5. Fit door glass regulator handle to regulator and secure with screw. Fit screw cover.
6. Position door pull, fit and tighten 2 screws.
7. Close door.

DOOR LOCK

Service Repair No. 76.37.12

Remove

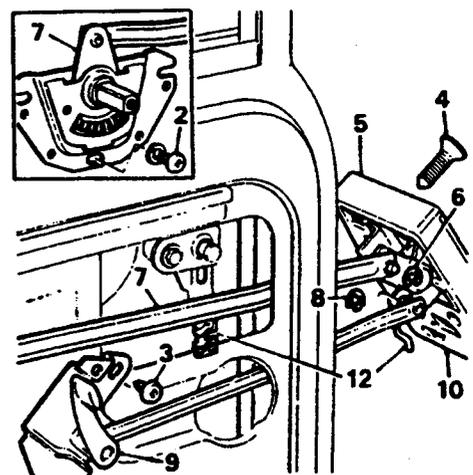

1. Remove the door trim casing, see **Door trim casing**.
2. Remove 3 screws securing interior door handle control to door panel.
3. Remove 2 screws securing the interior door lock lever to door panel.
4. Remove 4 screws securing door lock assembly to door.
5. Pull door lock assembly from door.
6. Remove circlip securing interior door handle control to lock assembly.
7. Remove interior door handle control from inner door panel.
8. Remove circlip securing interior door lock lever to lock assembly.
9. Remove interior door lock lever from inner door panel.
10. Remove door lock assembly.

Refit

11. Position door lock assembly to door and connect interior door lock lever and interior door handle control, secure with clips.
12. Fit door lock into door aperture, fit and tighten screws.

Note: When refitting door lock into aperture in door, engage exterior handle operating crank with retaining clip on private lock.

13. Align interior door handle control to inner door panel, fit and tighten screws.
14. Align interior door lock lever to inner door panel, fit and tighten screws.
15. Fit door trim casing, see **Door trim casing**.

DOOR EXTERIOR HANDLE AND PRIVATE LOCK

Service Repair No.

Exterior door handle: 76.58.01

Private lock: 76.37.39

Remove

1. Remove door lock assembly, see **Door lock**.

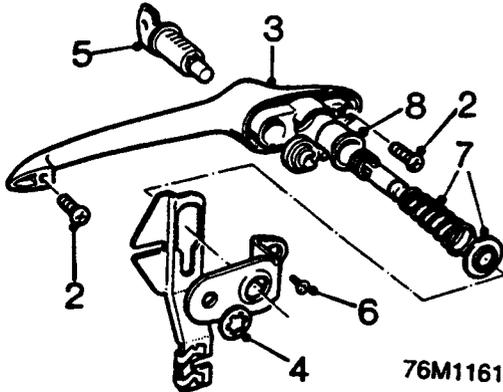

2. Remove 2 screws securing handle to door.
3. Remove exterior handle and sealing rubbers.
4. Remove clip securing door private lock to handle.
5. Insert key into private lock and withdraw it from handle.
6. Remove screw securing retaining plate to handle.
7. Remove retaining plate, private lock operating link, washer and spring.
8. Remove push button.

Refit

1. Fit push button, washer and spring, private lock operating link and retaining plate.
2. Secure retaining plate to handle with screw.
3. Fit private lock to handle and secure with clip.
4. Position exterior handle and sealing rubbers, fit and tighten securing screws.
5. Fit door lock assembly, see **Door lock**.

DOOR GLASS REGULATOR

Service Repair No. 76.31.45

Remove

1. Remove door trim casing, see **Door trim casing**.

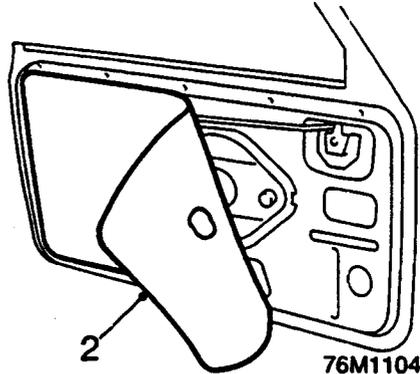

2. Carefully remove plastic sealing sheet.
3. Fit door glass regulator handle, secure with screw.

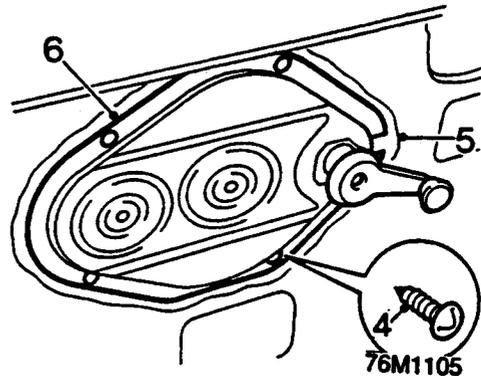

4. Remove 4 screws securing regulator to door.
5. Remove sealer from front of regulator panel to expose locating tag.
6. Release regulator panel from door skin.
7. Turn regulator to position glass to top of travel.

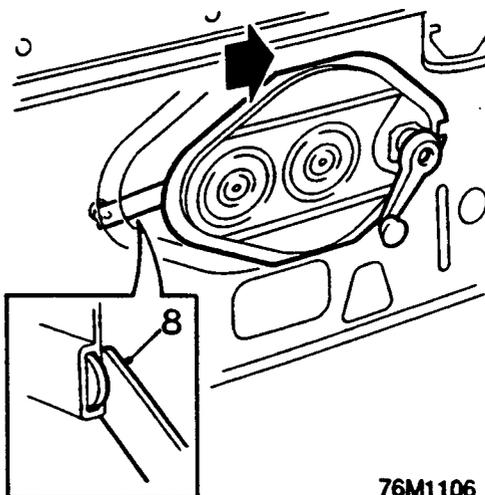

8. Slide regulator forward and disconnect rear regulator arm from glass channel.



DOOR GLASS

Service Repair No. 76.31.01

Remove

1. Remove door trim casing, see **Door trim casing**.
2. Remove door glass regulator, see **Door glass regulator**.

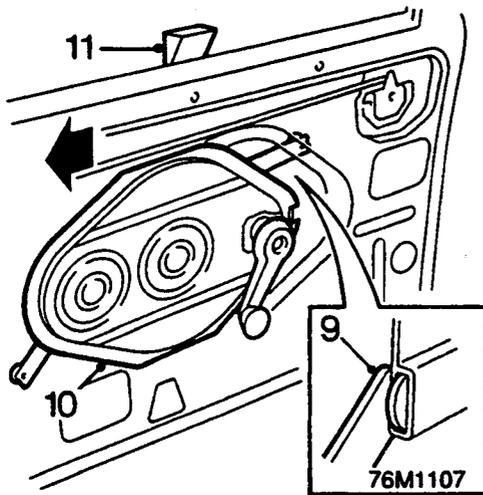

9. Slide regulator rearwards and disconnect front arm from glass channel.
10. Remove regulator assembly.
11. Wedge glass in channel.
12. Remove screw securing regulator handle and remove handle.

Refit

1. Fit regulator handle to new regulator and fit and tighten screw.
2. Apply sealant to edge of regulator aperture in door.
3. Turn regulator to top of travel and position regulator to door.
4. Remove wedge from glass, engage regulator front arm in glass channel and slide regulator forward.
5. Engage rear arm in channel.
6. Turn handle to position regulator to door, engage location tab and align screw holes.
7. Fit and tighten 4 screws securing regulator.
8. Apply sealant over location tab.
9. Remove screw from regulator handle and remove regulator handle.
10. Reseal plastic sealing sheet to door.
11. Fit door trim casing, see **Door trim casing**.

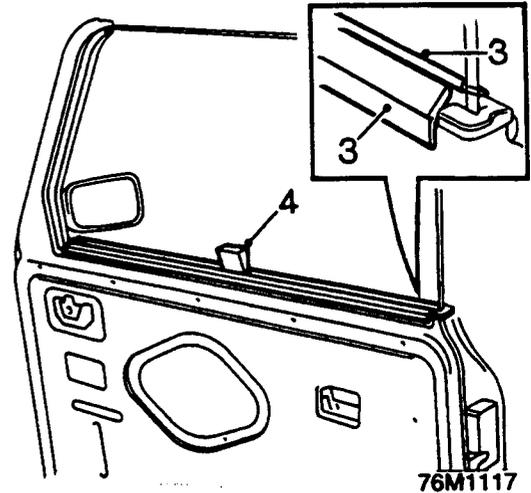

3. Remove door glass inner and outer weather strips.
4. Remove wedge supporting door glass.

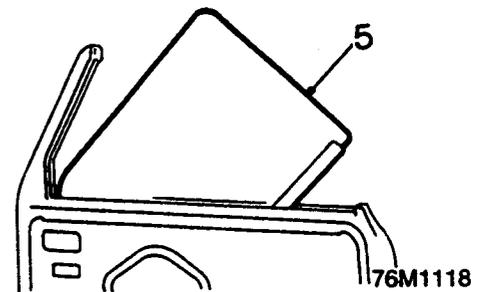

5. Tilt and remove glass.

Refit

1. Lubricate glass channels.
2. Fit glass to door.
3. Engage glass in channels.
4. Position glass to top of travel.

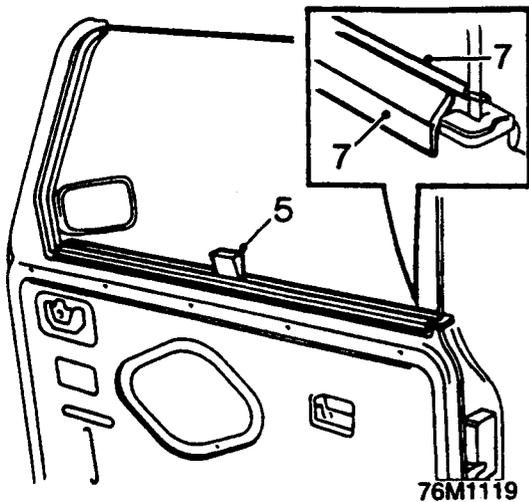

5. Fit wedge to hold glass at top of travel.
6. Fit door glass regulator, see **Door glass regulator**.
7. Fit glass inner and outer weather strips.
8. Fit door trim casing, see **Door trim casing**.

DOOR LOCK STRIKER PLATE

Service Repair No. 76.37.23

Remove

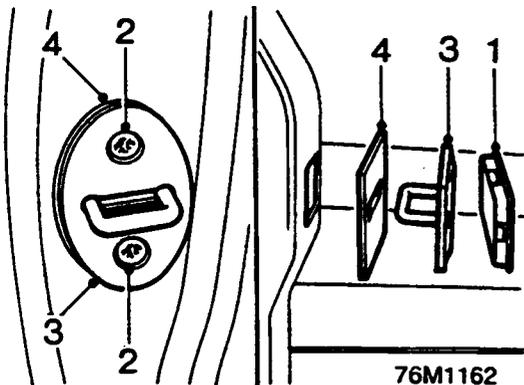

1. *Saloon models:* Remove striker plate cover from 'B' post.
Cabriolet models: Remove rear quarter trim panel, see **Rear quarter trim panel - Cabriolet**.
2. Remove 2 screws securing striker lock to striker plate.
3. Remove the striker lock and striker plate.
4. Remove 2 foam seals from 'B' post.

Refit

1. Fit foam seals to 'B' post.
2. Align striker plate and striker lock on 'B' post, fit screws but do not tighten.
3. Close door firmly.

CAUTION: Do not slam door.

4. Carefully open door without disturbing position of strike.
5. Tighten striker lock screws.
6. Close door, check alignment and re-position striker as necessary.
7. *Saloon models:* Fit striker plate cover to 'B/C' post
Cabriolet models: Fit rear quarter trim panel, see **Rear quarter trim panel - Cabriolet**.

LUGGAGE COMPARTMENT LID

Service Repair No. 76.19.01

Remove

1. Remove rear number plate lamp housing, see **ELECTRICAL - Repairs**.
2. Remove screws securing number plate to lid.
3. Remove luggage compartment lock, see **Luggage compartment lid handle and lock assembly**.
4. Carefully remove badge(s) from lid.

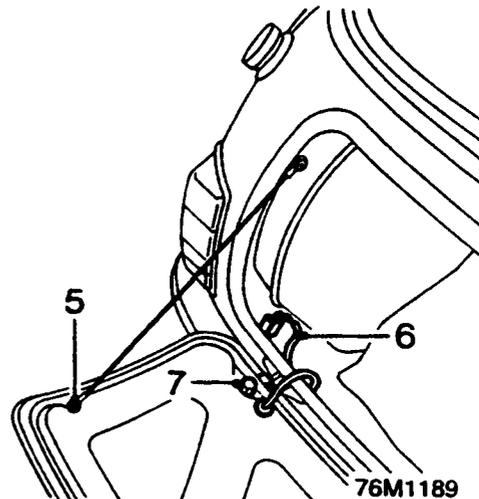

5. Remove 2 screws retaining stays to lid.
6. Disconnect 2 body harness connectors, release grommet and remove number plate lamp harness.
7. Support luggage compartment lid, remove 4 nuts securing lid to hinges.
8. Remove luggage compartment lid and hinge joint washers.



Refit

1. Fit luggage compartment lid and hinge joint washers.
2. Fit retaining nuts but do not tighten.
3. Close luggage compartment and adjust alignment to equalise gap to adjacent body panels.
4. Open luggage compartment, tighten 4 nuts to 10 Nm.
5. Fit stays to lid and secure with screws.
6. Position number plate lamp harness to lid, fit grommet and connect to body harness.
7. Fit luggage compartment lid handle, see **Luggage compartment lid handle and lock assembly**.
8. Fit rear number plate lamp housing, see **ELECTRICAL - Repairs**.
9. Fit badge(s) to lid.
10. Position number plate to lid and secure with screws.

LUGGAGE COMPARTMENT LID HANDLE AND LOCK ASSEMBLY

Service Repair No. 76.19.17

Remove

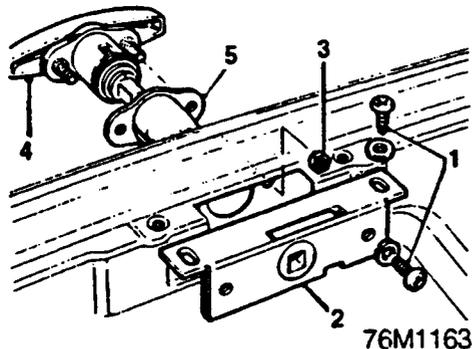

1. Remove 4 screws securing the lock assembly to luggage compartment lid.
2. Remove lock assembly.
3. Remove 2 nuts securing handle and private lock to luggage compartment lid.
4. Remove handle.
5. Remove sealing rubber from lid.

Refit

1. Fit sealing rubber to luggage compartment lid.
2. Fit handle and private lock assembly, secure with nuts.
3. Fit lock assembly to lid, fit and tighten screws.

LUGGAGE COMPARTMENT LID PRIVATE LOCK

Service Repair No. 76.19.19

Remove

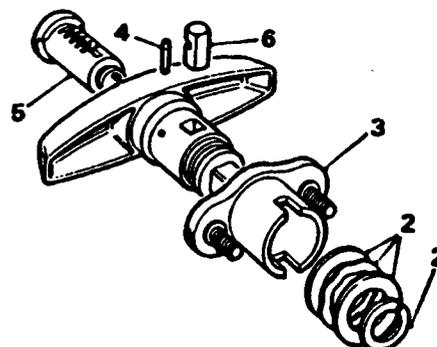

76M1174

1. Remove luggage compartment lid handle, see **Luggage compartment lid handle and lock assembly**.
2. Remove the spring clip, 2 flat washers and wave washer.
3. Remove the handle yoke.
4. Use a pin punch to drive out the private lock barrel retaining pin.
5. Remove the private lock from the lock body.
6. Remove the locking pin.

Refit

1. Fit locking pin and lock into body.
2. Fit private lock barrel retaining pin.
3. Fit yoke to handle and secure in place with washers and spring clip.
4. Fit handle to luggage compartment lid, see **Luggage compartment lid handle and lock assembly**.

BODY

FRONT GRILLE

Service Repair No. 76.55.03

Remove

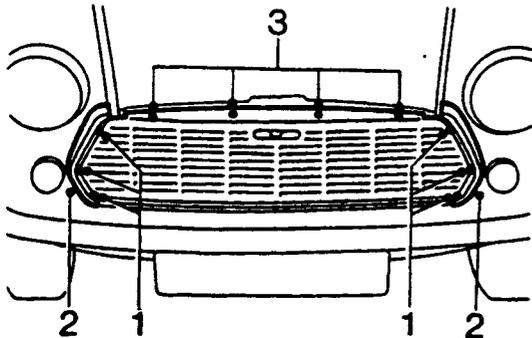

76M1164

1. Remove 6 screws securing front grille side finishers to body.
2. Remove side finishers.
3. Remove 4 screws securing grille to aperture.
4. Remove front grille.

Refit

1. Position front grille to aperture, ensure that it is centrally located; fit and tighten screws.
2. Position grille side finishers and secure with screws.

FRONT TOWING BRACKET

Remove

1. Raise front RH side of vehicle.

WARNING: Support on safety stands.

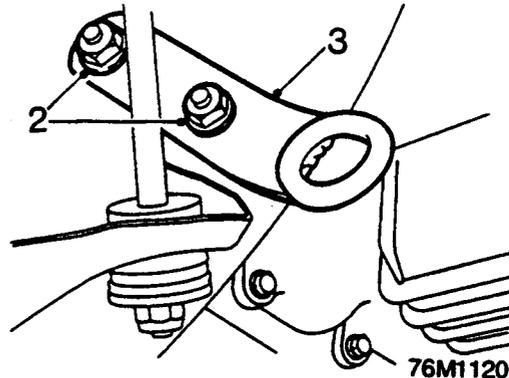

76M1120

2. Remove 2 bolts and nuts securing towing bracket to subframe.
3. Remove towing bracket.

Refit

1. Position towing bracket to subframe.
2. Fit and tighten 2 bolts and nuts.
3. Remove supports and lower the vehicle.



WINDSCREEN

Service Repair No. 76.81.01

Remove

1. Remove the windscreen wiper arms, see **WIPERS & WASHERS - Repairs.**

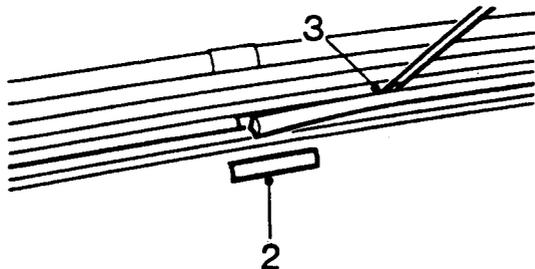

76M1165

2. Remove the chrome finisher plate from the sealing rubber.
3. Use a small screwdriver to extract one end of finisher strip and carefully withdraw it from the sealing rubber.
4. With an assistant supporting the glass from the outside, commencing at the top corner, press the windscreen outwards from the sealing rubber.
5. Remove windscreen and sealing rubber.

Inspection

1. Remove any glass particles from sealing rubber channels and examine sealing rubbers for cuts and other damage.
2. Check body aperture for distortion or damage to flange.
3. If windscreen has broken, ensure that all particles of glass are removed from demister ducts, tubes and apertures.

Refit

1. Align windscreen sealing rubber to aperture and secure to flange.
2. Insert a cord into window groove of sealing rubber.
3. Position windscreen glass to sealing rubber. Apply pressure to outside of glass and use the cord to pull lip of seal over the edge of glass.

Note: Apply soap solution around seal to aid fitment.

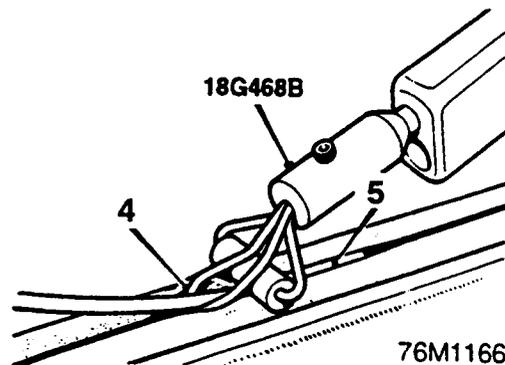

76M1166

4. Thread end of the finisher strip through eye of tool 18G 468 B and under roller.
5. Starting at the top centre of the window sealing rubber, insert eye of tool into finisher strip groove.
6. Slowly push tool around entire length of seal, feeding finisher strip into groove as the eyelet on tool opens it and use the roller to bed it into seal.
7. Fit chrome finisher plate into sealing rubber.

BODY

REAR WINDOW

Service Repair No. 76.81.10

Remove

1. Remove the chrome finisher plate from the sealing rubber
2. Use a small screwdriver to extract one end of the finisher strip and carefully withdraw it from the sealing rubber.
3. Disconnect 2 Lucars from heated rear window elements.
4. With an assistant supporting the glass from the outside, commencing at the top corner, press the rear window outwards from sealing rubber.
5. Remove rear window from sealing rubber.
6. Remove the sealing rubber from rear window aperture.

Refit

1. Align rear window sealing rubber to aperture and secure to flange.
2. Insert a cord into the window groove of the sealing rubber.
3. Position the rear window glass to the sealing rubber. Apply pressure to the glass and use the cord to pull the lip of the seal over the edge of the glass.

Note: Apply soap solution around seal to aid fitment.

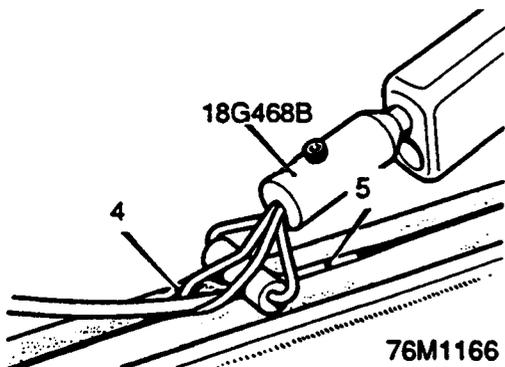

4. Thread the end of the finisher strip through the eye of 18G 468 B and under the roller.
5. Starting at the top centre of the window sealing rubber, insert the eye of the tool into the finisher strip groove.
6. Slowly push tool around entire length of seal, feeding finisher strip into groove as the eyelet on tool opens it and use the roller to bed it into the seal.
7. Fit chrome finisher plate into sealing rubber.
8. Reconnect 2 Lucars to heated rear window elements.

QUARTER VENT GLASS

Service Repair No. 76.81.19

Remove

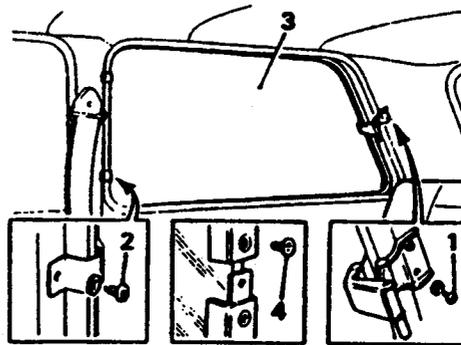

76M1167

1. Remove 2 screws securing quarter vent window catch to 'D' post.
2. Remove 2 screws securing quarter vent hinges to the 'B/C' post.
3. Remove the quarter vent glass from the window aperture.

Do not carry out further dismantling if component is removed for access only

4. Remove screw securing two ends of window finisher together and remove finisher.
5. Fit finisher to window and secure ends together with screw.

Refit

1. Using assistance, position quarter glass to body.
2. Fit and tighten screws, window hinges to 'B/C' post.
3. Fit and tighten screws, window catch to 'D' post.



REAR QUARTER TRIM PANEL

Service Repair No. 76.13.13

Remove

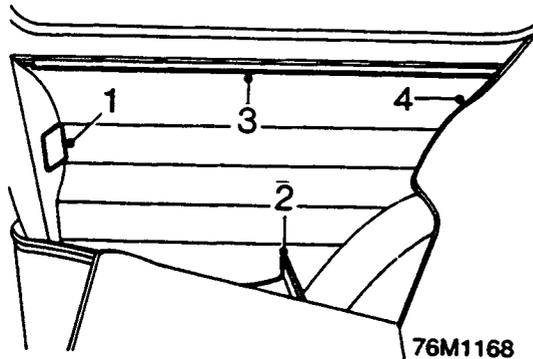

1. Remove striker plate cover from 'B' post.
2. Remove companion box floor cover.
3. Press the centre of the trim panel inwards and release from body flange.
4. Pull back edge of seat squab, release and remove rear quarter trim panel.

Refit

1. Fit rear quarter trim panel and secure under body flange.
2. Fit companion box floor
3. Fit striker plate cover to 'B' post.

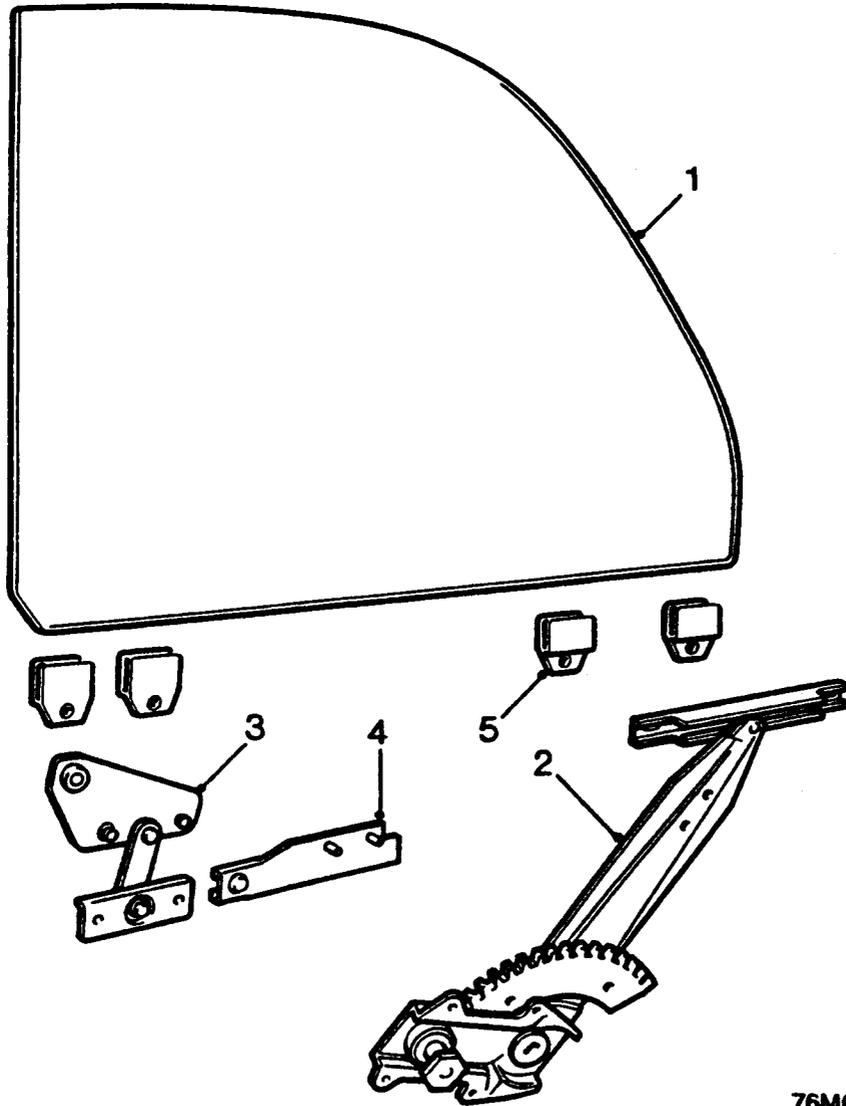

76M0698

REAR WINDOW COMPONENTS - CABRIOLET

1. Window glass
2. Window glass regulator
3. Window glass pivot
4. Window glass runner
5. Window glass clamp



REAR QUARTER TRIM PANEL - CABRIOLET

Service Repair No. 76.13.12

Remove

1. Remove rear seat cushion and squab, see **Rear seat**.
2. Lower the rear quarter glass.

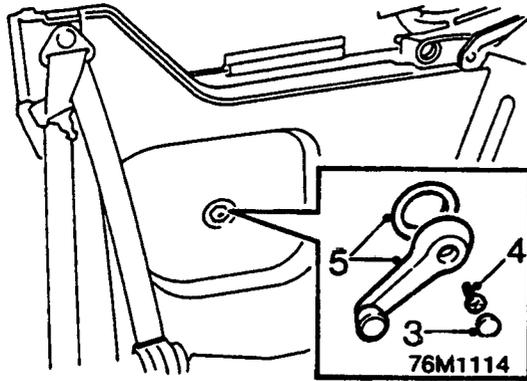

3. Remove cap from rear glass regulator handle.
4. Remove screw securing handle to regulator.
5. Remove handle and escutcheon.

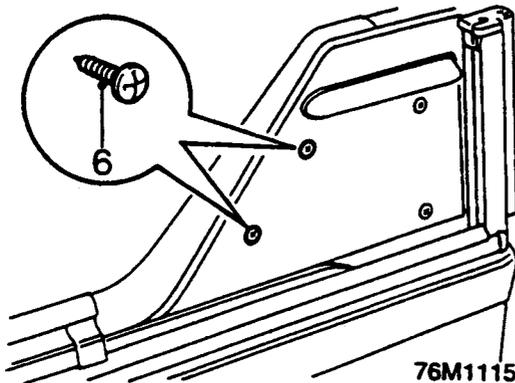

6. Remove 2 screws securing rear quarter trim panel to seat belt pillar.

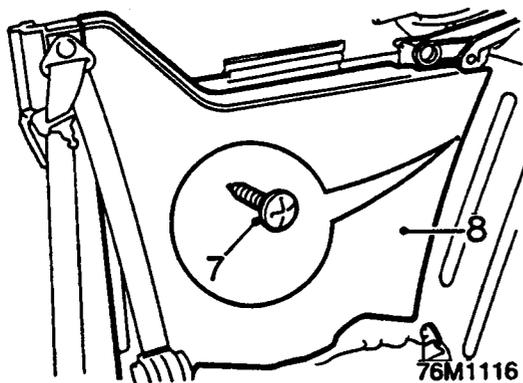

7. Remove screw securing rear edge of trim panel to body.
8. Release trim panel from body, lift panel clear of front seat belt reel to remove.

Refit

1. Fit trim panel and fit and tighten screw to body.
2. Fit and tighten screws, seat belt pillar to trim panel.
3. Fit regulator handle and escutcheon.
4. Fit and tighten screw, fit screw cover.
5. Raise rear quarter glass.
6. Fit rear seat squab and cushion, see **Rear seat**.

REAR QUARTER GLASS REGULATOR - CABRIOLET

Service Repair No. 76.81.51

Remove

1. Release hood catches and fold hood down.
2. Remove rear seat cushion and squab, see **Rear seat**.
3. Lower rear quarter glass and remove rear quarter trim panel, see **Rear quarter trim panel - Cabriolet**.

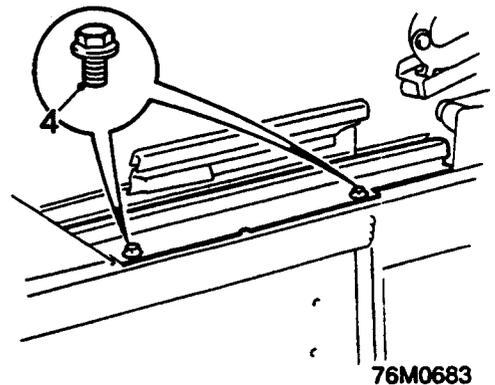

4. Remove 2 bolts securing glass inner seal to body and remove seal.

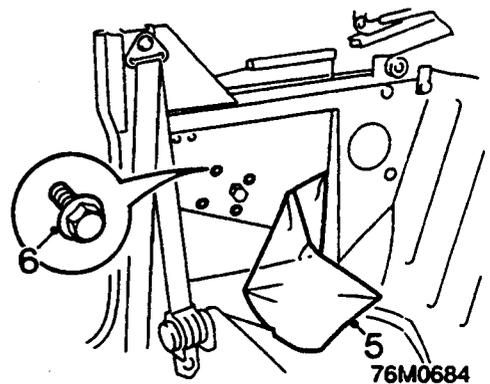

5. Remove plastic sealing sheet from rear quarter inner panel.
6. Remove 4 bolts securing regulator to quarter panel.

REAR QUARTER GLASS - CABRIOLET

Service Repair No. 76.81.50

Remove

1. Remove glass regulator, see **Rear quarter glass regulator - Cabriolet**.

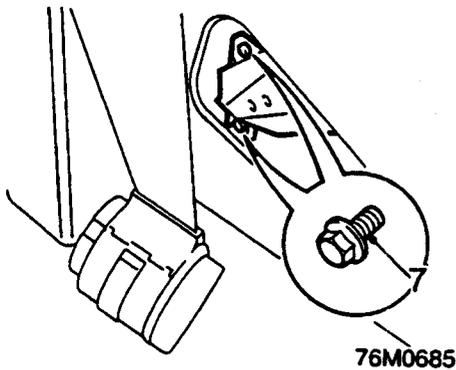

7. Raise glass to gain access to 2 bolts securing glass to regulator and remove.
8. Release regulator arm from glass.

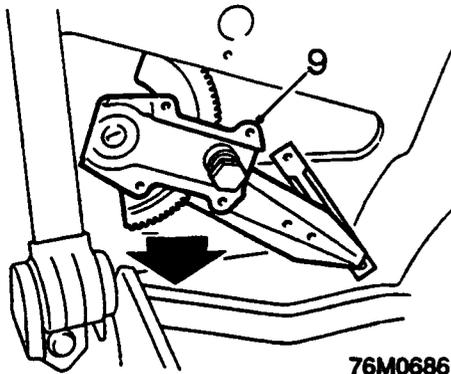

9. Raise glass fully and remove regulator from inner panel.
10. Lower the rear quarter glass.

Refit

1. Raise glass and position regulator to inner panel.
2. Align regulator arm to glass, fit and tighten 2 bolts.
3. Align regulator to inner panel, fit and tighten 4 bolts.
4. Reseal plastic sealing sheet to inner panel.
5. Fit glass inner seal and fit and tighten 2 bolts.
6. Fit rear quarter trim casing, see **Rear quarter trim panel - Cabriolet**.
7. Fit rear seat cushion and squab, see **Rear seat**.
8. Raise rear quarter glass.
9. Raise and secure hood.

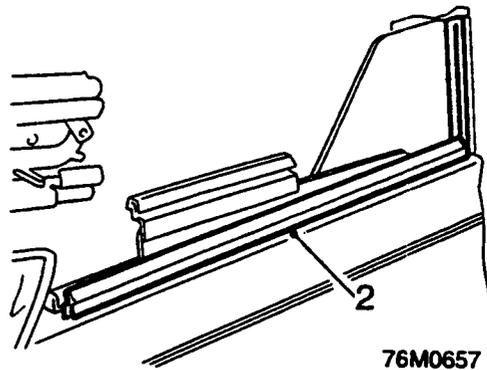

2. Release rear quarter glass outer seal and remove from body.

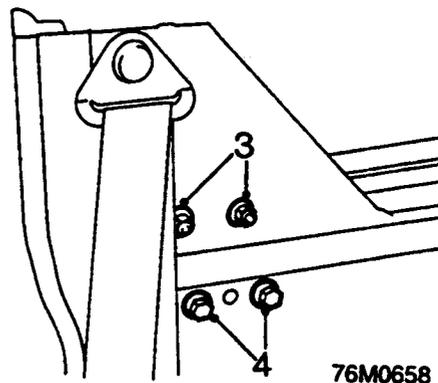

3. Remove 2 nuts securing glass pivot runner to body.
4. Remove 2 bolts securing glass pivot to inner panel.

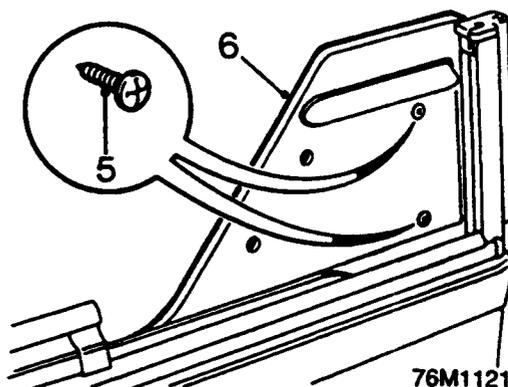

5. Remove 2 screws securing seat belt pillar finisher to body.
6. Remove finisher.

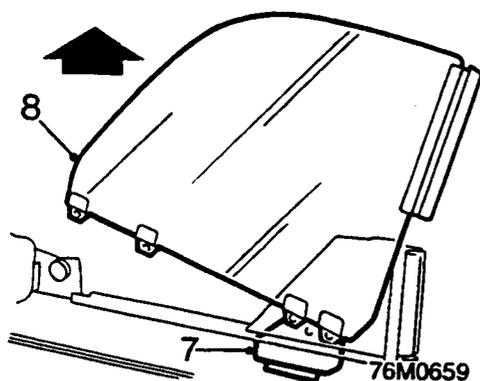

7. Release glass from runner and remove glass.
8. Remove glass runner from body.

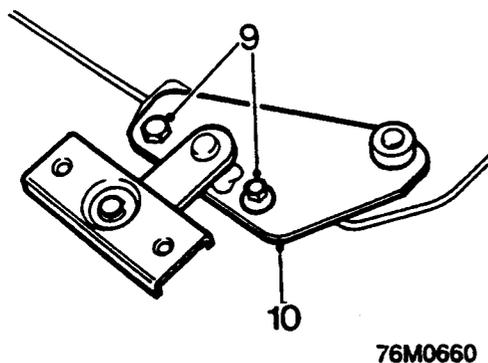

9. Remove 2 bolts securing pivot bracket to glass.
10. Remove pivot bracket.

Refit

1. Position pivot bracket to glass, fit and tighten 2 bolts.
2. Fit glass runner to body.
3. Fit glass to body and engage roller on glass into glass runner on body.
4. Align glass pivot to body, fit and tighten nuts and bolts securing glass pivot and runner.
5. Position seat belt pillar finisher and secure with screws.
6. Fit rear quarter glass outer seal to body.
7. Fit regulator, see **Rear quarter glass regulator - Cabriolet**.

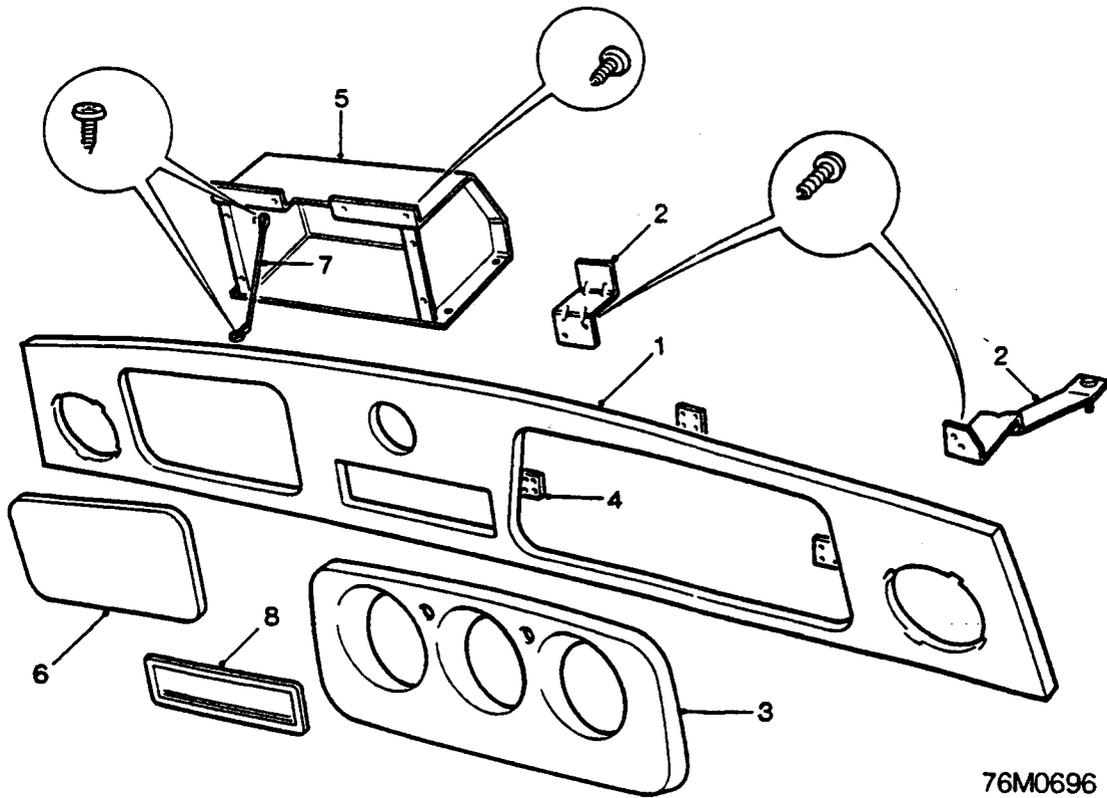

76M0696

WOODEN FASCIA COMPONENTS

1. Fascia Panel
2. Fascia Panel Mounting Brackets
3. Instrument Bezel Assembly
4. Instrument Bezel Assembly Securing Plates
5. Glove Box Liner
6. Glove Box Lid
7. Glove Box Lid Stay
8. Radio Blanking Plate (If fitted)



WOODEN FASCIA

Service Repair No. 76.46.23

Remove

1. Open both doors and boot.
2. Disconnect battery.

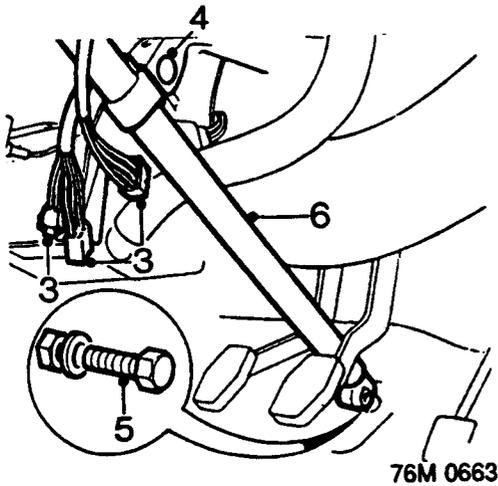

3. Disconnect 3 steering column switch multiplugs.
4. Drill out shear bolt securing steering column clamp to body bracket.
5. Remove nut and bolt securing steering inner column clamp to steering rack pinion.
6. Release column from steering rack pinion and remove from vehicle.

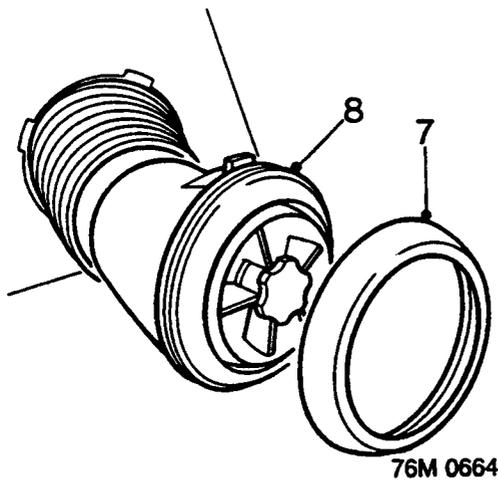

7. Remove both face level vent locking rings.
8. Remove both face level vents and tubes.
9. Remove radio, see **ELECTRICAL - Repairs**.

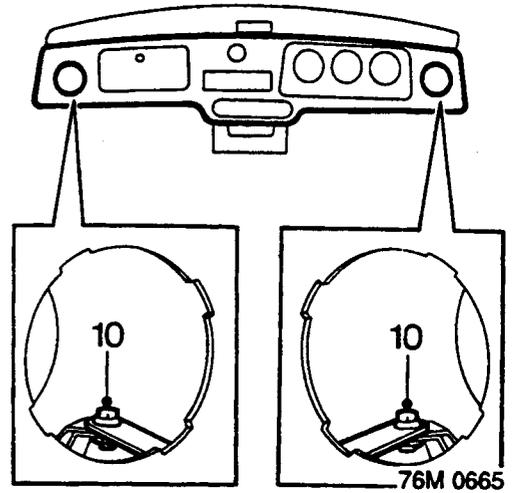

10. Working through face level vent apertures, slacken 2 bolts securing fascia brackets
11. Remove nut securing centre fascia bracket to body.
12. Release fascia and pull forward.

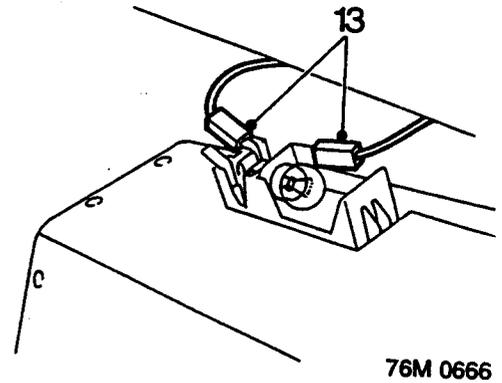

13. Disconnect 2 Lucars from glove box lamp.

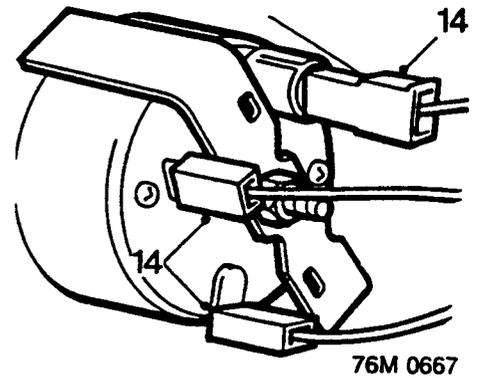

14. Disconnect 3 Lucars from clock.
15. Remove fascia panel assembly.

BODY

Do not carry out further dismantling if component is removed for access only

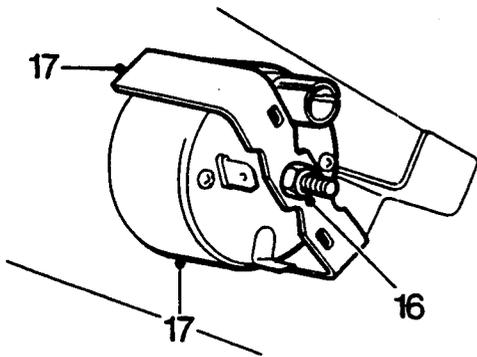

76M 0669

16. Remove nut securing clock retaining bracket.
17. Remove retaining bracket and clock.

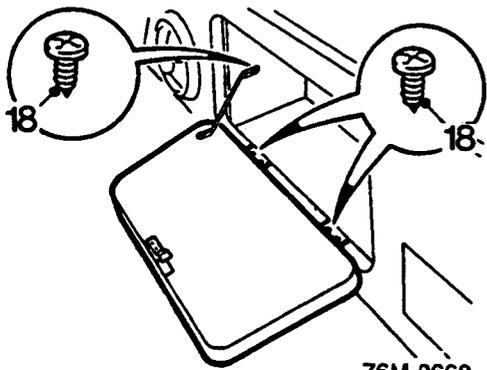

76M 0668

18. Remove 5 screws and remove glove box lid.

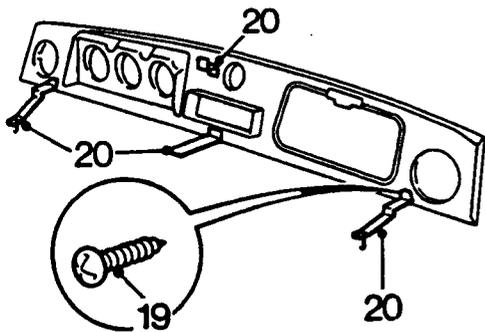

76M 0671

19. Remove 8 screws securing mounting brackets to fascia.
20. Remove 4 mounting brackets.

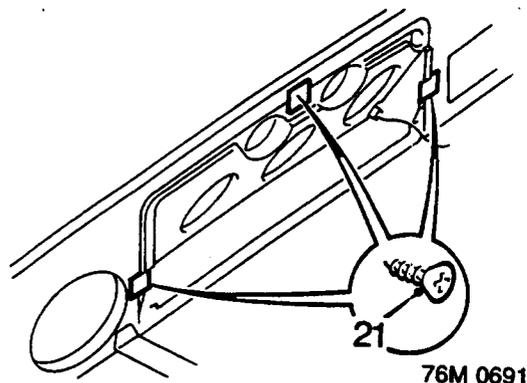

76M 0691

21. Remove 12 screws securing instrument bezel retaining plates to fascia.
22. Remove instrument bezel.

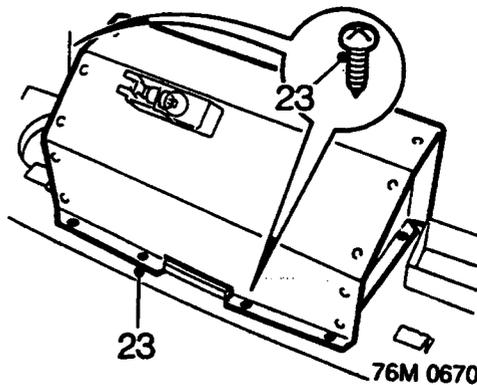

76M 0670

23. Remove 11 screws securing glove box liner to fascia, position glove box liner to new fascia and secure with screws.
24. Fit instrument bezel to new fascia and secure with screws.
25. Fit mounting brackets to fascia and secure with screws.
26. Fit glove box lid and secure with screws.
27. Fit clock, retaining bracket and secure with nut.
28. Fit radio and side finishers (if fitted) to radio.

Refit

1. Fit fascia panel to vehicle.
2. Connect 2 Lucars to glovebox light.
3. Connect 3 Lucars to clock.
4. Fit fascia to bulkhead, align mounting brackets, tighten 2 securing bolts fit and tighten nut.
5. Fit radio, see **ELECTRICAL - Repairs**.
6. Fit door sealing rubbers.
7. Fit face level vent tubes and vents, and secure with locking rings.
8. Fit steering column assembly to steering rack pinion and align with bracket on body.
9. Fit and tighten nut and bolt securing steering column to steering rack pinion.
10. Fit and tighten shear bolt securing steering column to body bracket.
11. Connect 3 steering column switch multiplugs.
12. Connect battery and close boot and doors.



GLOVE BOX LID

Service Repair No. 76.52.02

Remove

1. Open glove box lid.

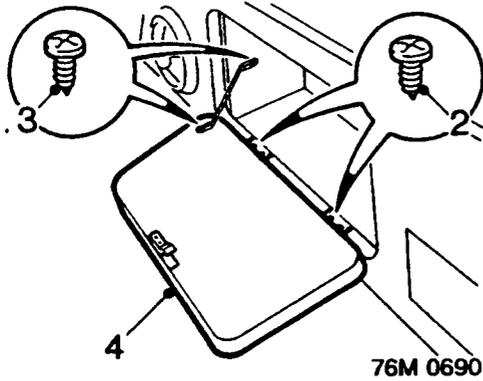

76M 0690

2. Remove 4 screws securing hinges to lid.
3. Remove 2 screws securing stay to lid.
4. Remove lid.

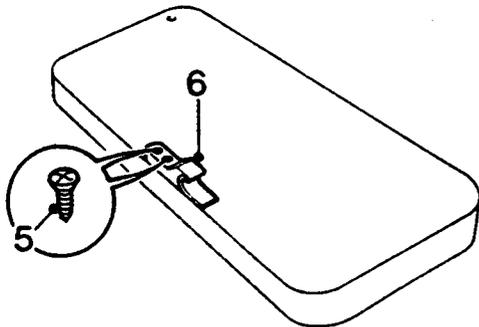

76M 0689

5. Remove 2 screws securing catch to lid.
6. Remove catch.

Refit

1. Fit catch to lid and fit and tighten 2 securing screws.
2. Position lid, fit and tighten 4 screws securing lid to hinges.
3. Fit and tighten 2 screws securing stay to lid.
4. Close glove box lid.

FASCIA TOP RAIL

Service Repair No. 76.46.04

Remove

1. *Wooden fascia models:* Remove wooden fascia, see **Wooden fascia**
Non wooden fascia models: Remove fresh air vents, see **HEATING & VENTILATION**.

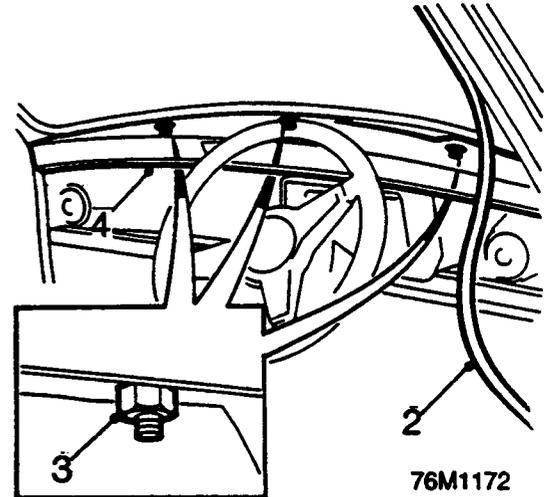

76M1172

2. Release door sealing rubbers from 'A' post.
3. Remove 3 nuts securing fascia top rail to bulkhead.
4. Lift front of rail to release mounting studs from bulkhead.
5. Remove fascia top rail

Do not carry out further dismantling if component is removed for access only

6. Remove ashtray assembly from fascia top rail.
7. Fit ashtray assembly to fascia top rail.

Refit

1. Position and fit fascia top rail to bulkhead.
2. Fit fascia top rail securing nuts and tighten to 10 Nm.
3. Fit door sealing rubbers to 'A' post.
4. *Wooden fascia models:* Fit wooden fascia, see **Wooden fascia**.
Non wooden fascia models: Fit fresh air vents, see **HEATING & VENTILATION**.

BODY

FRONT CARPET

Service Repair No. 76.42.02

Remove

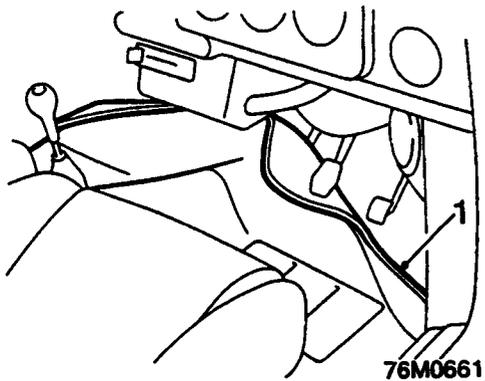

1. Release carpet from footwells and pedals.

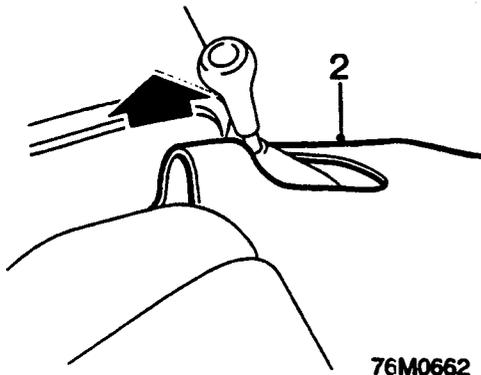

2. Release carpet from gear lever.
3. Remove carpet from car.

Refit

1. Fit carpet to car.
2. Fit carpet around gear lever under pedals and into footwells.

REAR CARPET - CABRIOLET

Service Repair No. 76.49.03

Remove

1. Remove both front seats, see Front seats - Cabriolet.

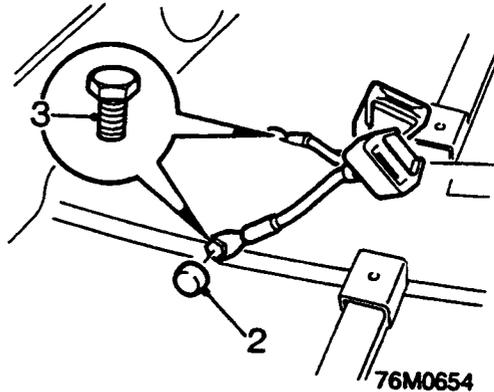

2. Remove bolt caps from both seat belt stalks.
3. Remove 2 bolts securing seat belt stalks to body.

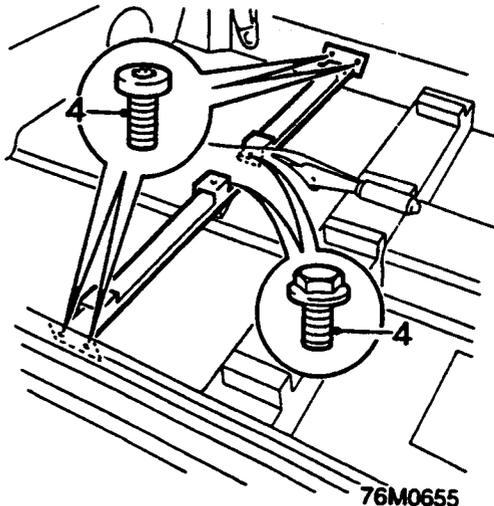

4. Remove 6 bolts securing front seat mounting supports to body.

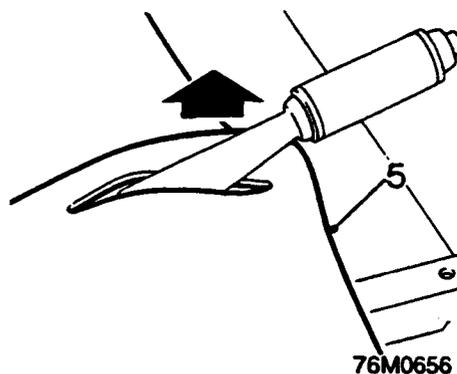

5. Release carpet from handbrake lever and remove rear carpet.



Refit

1. Fit carpet to car. Place over handbrake lever and into rear footwells.
2. Position front seat mounting supports, fit and tighten bolts.
3. Position seat belt stalks, fit and tighten 2 bolts.
4. Fit caps to seat belt stalk bolts.
5. Refit front seats, see **Front seat - Cabriolet**.

FRONT SEAT - CABRIOLET

Service Repair No. 78.10.44/99

Remove

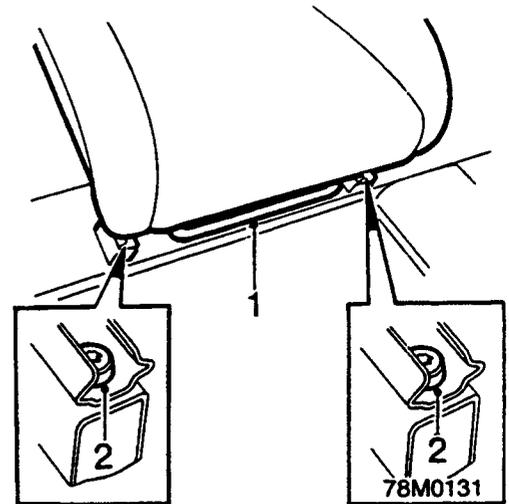

1. Open door, raise seat adjusting bar and slide seat backwards.
2. Remove seat 2 front securing bolts.

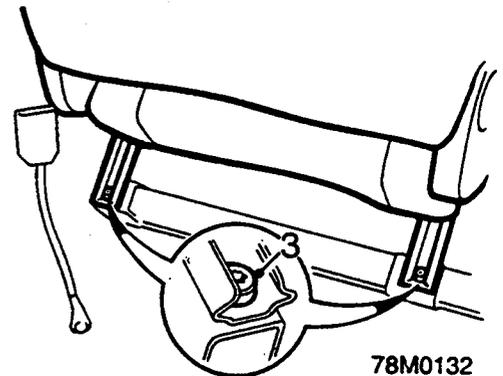

3. Slide seat forwards and remove 2 rear securing bolts.

FRONT SEAT - SALOON

Service Repair No. 78.10.44/99

Remove

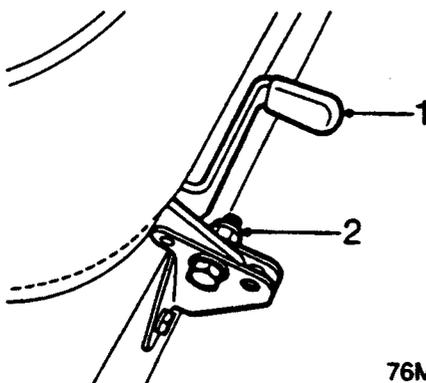

1. Raise lever and slide seat fully rearwards.
2. Remove 2 nuts and bolts securing seat to mounting brackets.
3. Lift and remove seat.

Refit

1. Position seat to mounting brackets.
2. Align bolt holes in mounting bracket with those on seat.
3. Fit and tighten seat mounting bolts and nuts.

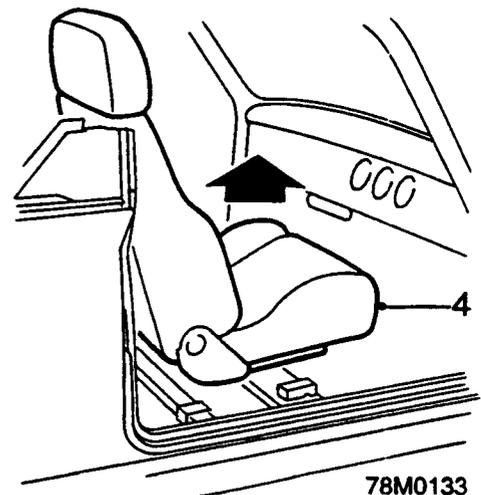

4. Lift and remove seat assembly.

Refit

1. Fit seat and align to rear bolt holes.
2. Fit but do not tighten 2 rear bolts.

BODY

3. Slide seat backwards align front bolt holes and fit and tighten 2 front bolts.
4. Slide seat forwards and tighten rear bolts.
5. Adjust seat to a central position and close door.

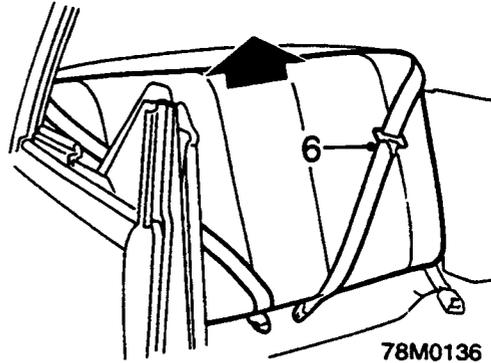

REAR SEAT

Service Repair No. 78.10.56/99

Remove

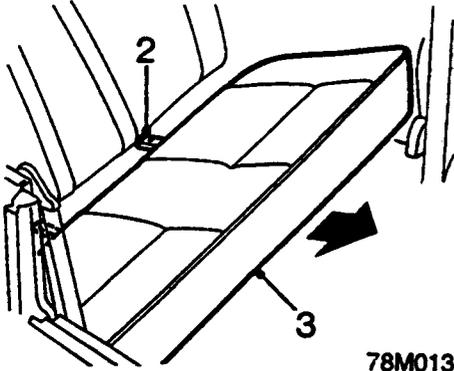

1. Release rear seat cushion from rear seat panel.
2. Remove 2 screws securing cushion straps to body.
3. Remove seat cushion.

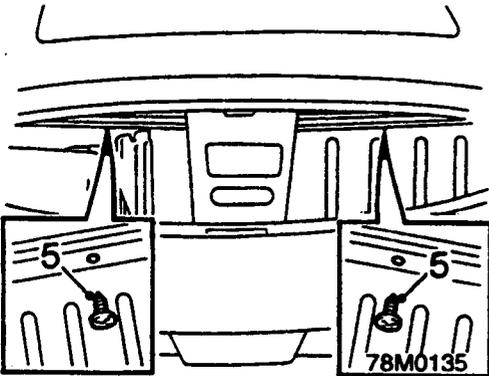

4. Open luggage compartment.
5. Remove 2 screws securing rear seat squab to rear parcel tray panel.

6. Pull seat belt harnesses away from squab.
7. Release and remove rear seat squab.

Refit

1. Fit rear seat squab to vehicle .
2. Align squab to rear parcel tray, fit and tighten 2 securing screws.
3. Close luggage compartment.
4. Align seat belts to seat squab.
5. Position seat cushion. Fit and tighten 2 securing screws.



FRONT SEAT BELTS - SALOON

Service Repair No. 76.73.10

WARNING: When seat belts have been in use in a vehicle which has been involved in an accident with a severe impact, the complete belt assemblies must be renewed, including the centre stalks.

Remove

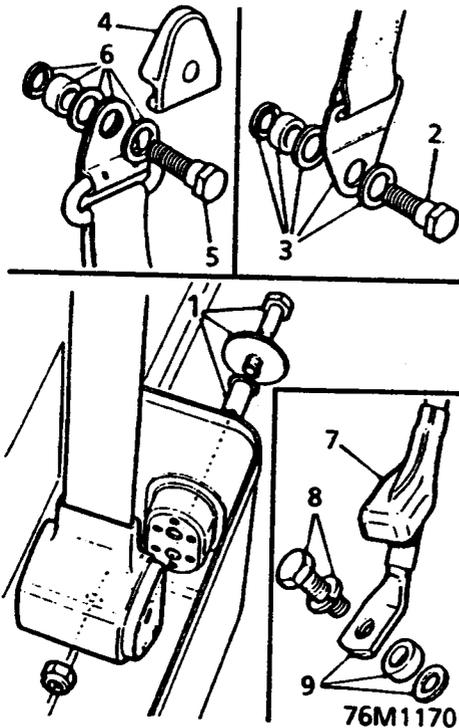

1. Remove nut and bolt securing the seat belt reel to companion box.
2. Remove bolt securing seat belt lower anchorage point to body.
3. Detach seat belt bracket from bolt and recover 2 nylon washers, spacer, and fibre washer.
4. Remove cover, seat belt upper anchorage point.
5. Remove upper anchorage bolt.
6. Detach the seat belt bracket from bolt and recover 2 nylon washers, spacer, and fibre washer.
7. Release cover from seat belt stalk bolt
8. Remove bolt and spring washer securing stalk to body.
9. Remove the stalk, collect spacer and fibre washer.

Refit

1. Fit bolt, spring washer, spacer and fibre washer to seat belt stalk.
2. Position seat belt stalk to body, tighten bolt to 32 Nm.
3. Position seat belt reel to companion box, fit and tighten nut and bolt to 32 Nm.

4. Fit bolts, nylon washers and spacers to seat belt mounting brackets.
5. Fit and tighten upper and lower anchorage bolts to 32 Nm.
6. Fit plastic covers to bolts.

FRONT SEAT BELTS - CABRIOLET

Service Repair No. 76.73.10

WARNING: When seat belts have been in use in a vehicle which has been involved in an accident with a severe impact, the complete belt assemblies must be renewed, including the centre stalks.

Remove

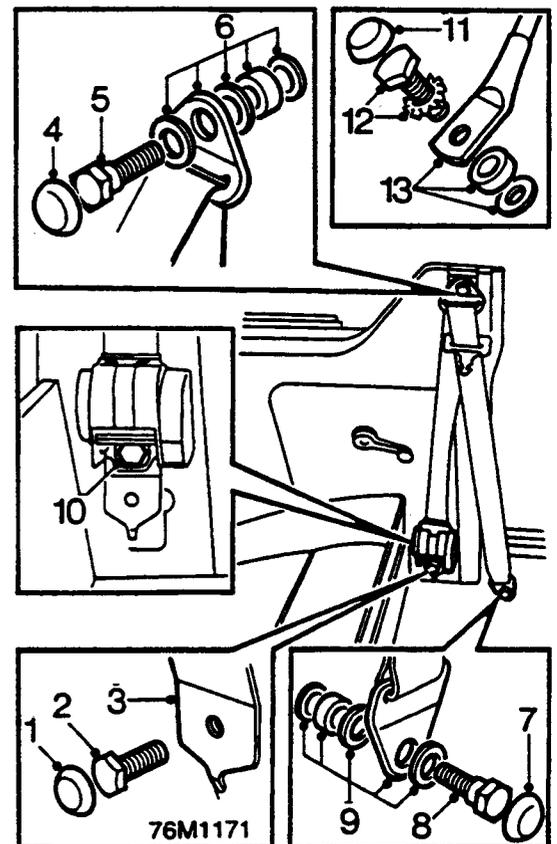

1. Remove cover from seat belt reel mounting bracket bolt.
2. Remove bolt securing mounting bracket to body.
3. Release mounting bracket from body.
4. Remove cover from seat belt upper anchorage point.
5. Remove upper anchorage bolt.
6. Detach the seat belt bracket from bolt and recover 2 nylon washers, spacer, and fibre washer.
7. Remove cover, seat belt lower anchorage point.

BODY

8. Remove lower anchorage bolt.
9. Detach the seat belt bracket from bolt and recover 2 nylon washers, spacer, and fibre washer.
10. Remove bolt securing mounting bracket to seat belt reel.
11. Release cover from seat belt stalk bolt
12. Remove bolt and spring washer securing stalk to body.
13. Remove the stalk, collect spacer and fibre washer.

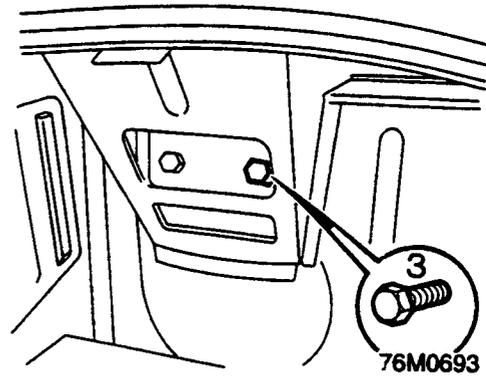

3. Open luggage compartment and remove bolt securing seat belt reel to mounting. Use assistance from inside car to hold the seat belt.

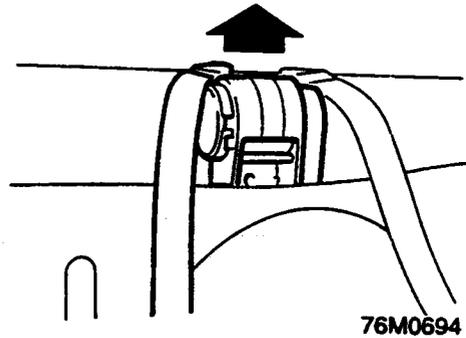

4. Lift and remove seat belt.

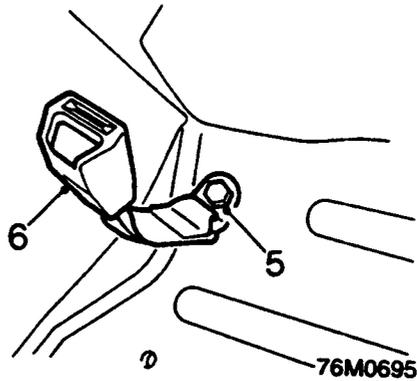

5. Remove bolt securing seat belt stalk.
6. Remove seat belt stalk.

Refit

1. Position seat belt stalk, fit and tighten bolt.
2. Fit seat belt reel and, with assistance, fit and tighten bolt from inside luggage compartment.
3. Extend seat belt and fit and tighten 2 bolts to body.
4. Fit bolt cover.
5. Fit rear seat cushion and squab, see **Rear seat**.

Refit

1. Fit bolt, spring washer, spacer and fibre washer to seat belt stalk.
2. Position seat belt stalk to body, tighten bolt to 32 Nm.
3. Locate mounting bracket on seat belt reel, fit bolt and tighten to 32 Nm.
4. Locate mounting bracket tab in hole on body, fit bolt and tighten to 32 Nm.
5. Fit bolts, nylon washers and spacers to seat belt mounting brackets.
6. Fit and tighten upper and lower anchorage bolts to 32 Nm.
7. Fit plastic covers to bolts.

REAR SEAT BELT - CABRIOLET

Service Repair No. 76.73.23

Remove

1. Remove rear seat cushion and squab, see **Rear seat**.

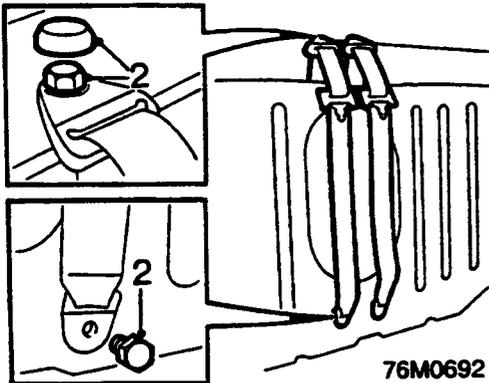

2. Remove seat belt bolt cover and remove 2 bolts securing seat belt to body.

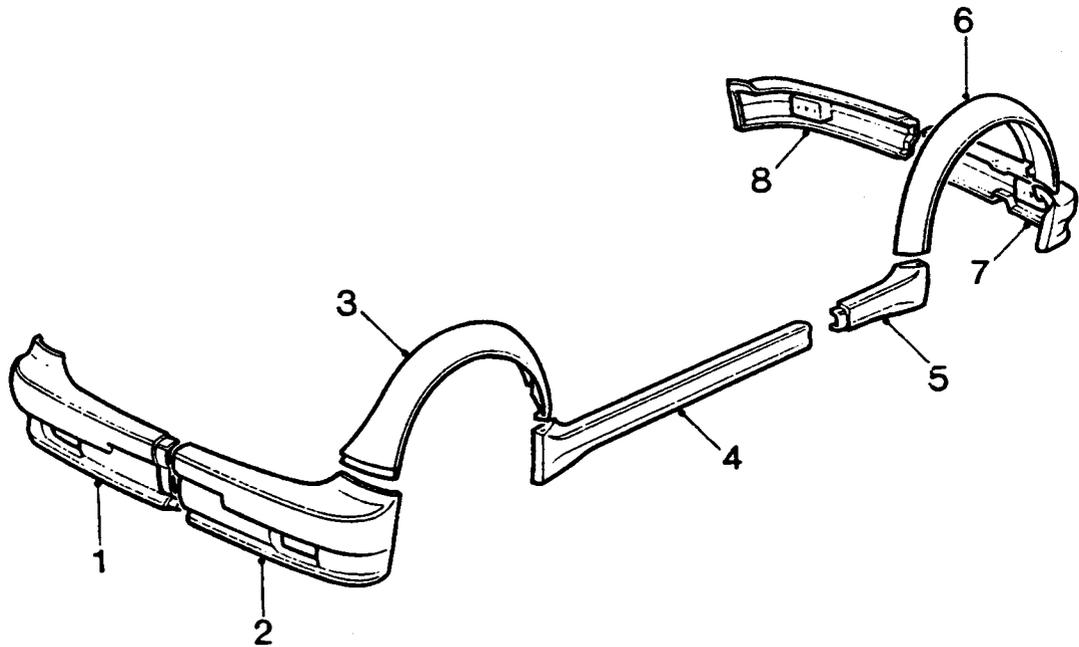

76M0697

BODY STYLING COMPONENTS

1. Front bumper - LH side
2. Front bumper - RH side
3. Front wheel arch finisher
4. Sill finisher - Front half
5. Sill finisher - Rear half
6. Rear wheel arch finisher
7. Rear bumper - RH side
8. Rear bumper - LH side

BODY

LH FRONT BUMPER

Service Repair No. 76.22.83

Remove

1. Raise front of vehicle.

WARNING: Support on safety stands.

2. Remove RH front bumper, see **RH front bumper**.
3. Remove LH front wheel arch finisher, see **Front wheel arch finisher**.

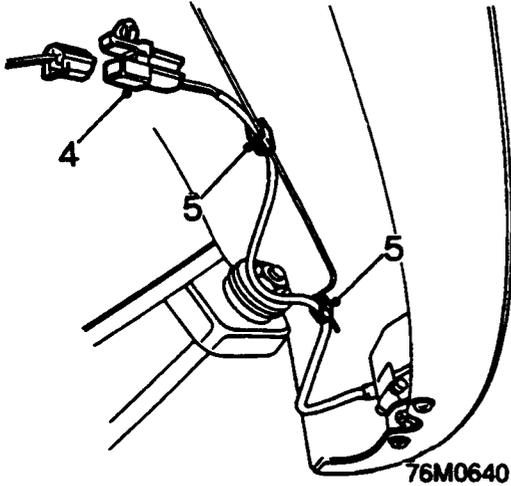

4. Disconnect driving lamp multiplug from main harness.
5. Release 2 clips securing lamp harness to body.

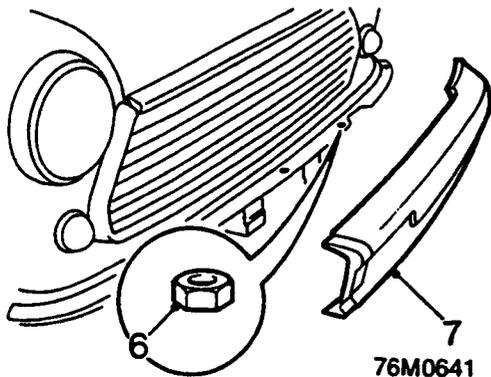

6. Remove 3 nuts securing bumper to body flange.
7. Remove LH front bumper.

Do not carry out further dismantling if component is removed for access only

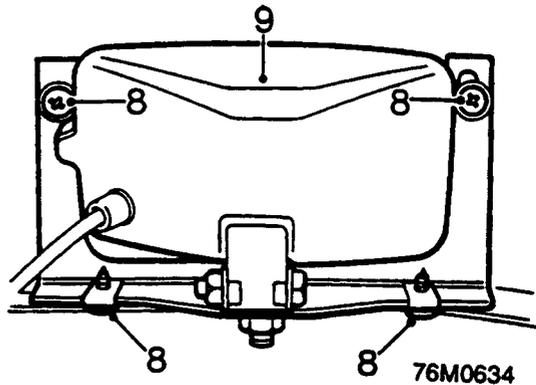

8. Remove 4 screws securing driving lamp bracket to bumper.
9. Remove lamp and bracket.
10. Position lamp and bracket assembly to new bumper, fit and tighten 4 screws.

Refit

1. Clean bumper and body flange mating faces.
2. Position bumper to body, fit and tighten 3 retaining nuts.
3. Connect driving lamp multiplug and secure harness to clips on body.
4. Fit RH bumper, see **RH front bumper**.
5. Fit LH front wheel arch finisher, see **Front wheel arch finisher**.
6. Remove stand(s) and lower vehicle.



RH FRONT BUMPER

Service Repair No. 76.22.83

Remove

1. Raise front of vehicle.

WARNING: Support on safety stands.

2. Remove RH front wheel arch finisher, see Front wheel arch finisher.

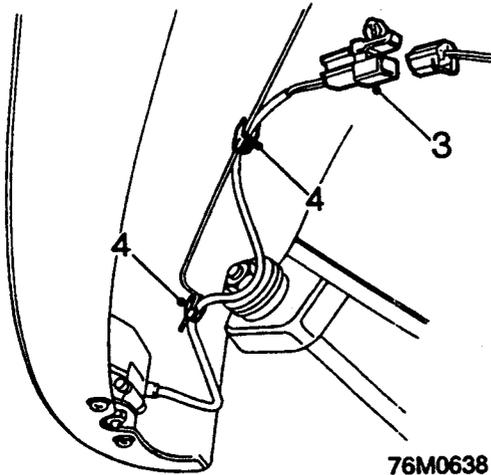

3. Disconnect driving lamp multiplug from main harness.
4. Release 2 clips securing lamp harness to body.

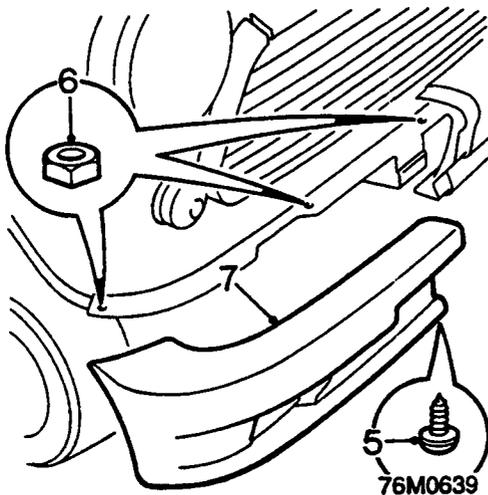

5. Remove screw securing two halves of the bumper together.
6. Remove 3 nuts securing bumper to body flange.
7. Remove RH front bumper.

Do not carry out further dismantling if component is removed for access only

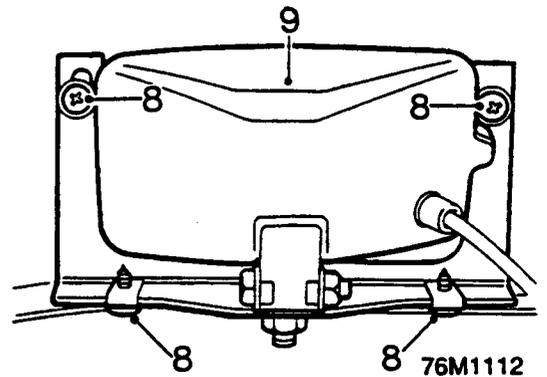

8. Remove 4 screws securing driving lamp bracket to bumper.
9. Remove lamp and bracket.
10. Position lamp and bracket assembly to new bumper, fit and tighten 4 screws.

Refit

1. Clean bumper and body flange mating faces.
2. Position bumper to body, fit and tighten 3 nuts.
3. Connect driving lamp multiplug and secure harness to clips on body.
4. Fit RH front wheel arch finisher, see Front wheel arch finisher.
5. Remove stand(s) and lower vehicle.

FRONT WHEEL ARCH FINISHER

Service Repair No. 76.43.54

Remove

1. Raise front of vehicle.

WARNING: Support on safety stands.

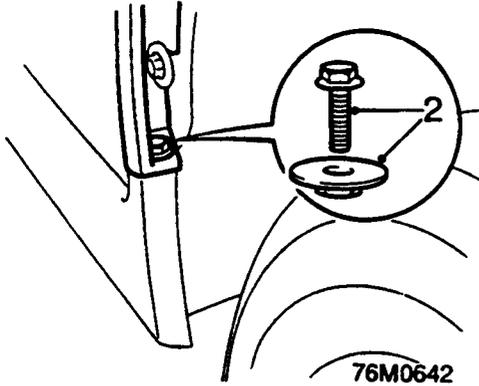

2. Remove nut and bolt securing wheel arch finisher to sill finisher.

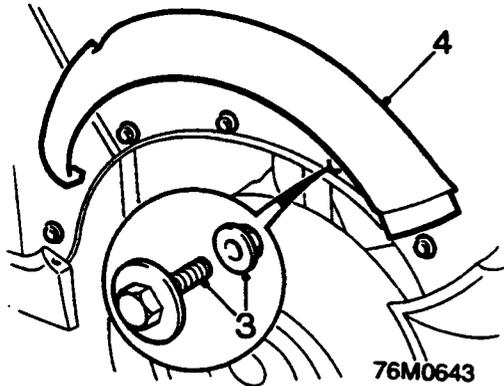

3. Slacken 5 nuts and bolts securing wheel arch finisher to front wing.
4. Release wheel arch finisher from wing and remove from front bumper.

Refit

1. Clean finisher, bumper and wing mating faces.
2. Fit wheel arch finisher to bumper, then to bolts on front wing.
3. Fit nut and bolt securing wheel arch finisher to sill finisher.
4. Tighten nuts and bolts securing finisher to wing.
5. Remove stand(s) and lower vehicle.

SILL FINISHER

Service Repair No. 76.43.51

Remove

1. Raise front of vehicle.

WARNING: Support on safety stands.

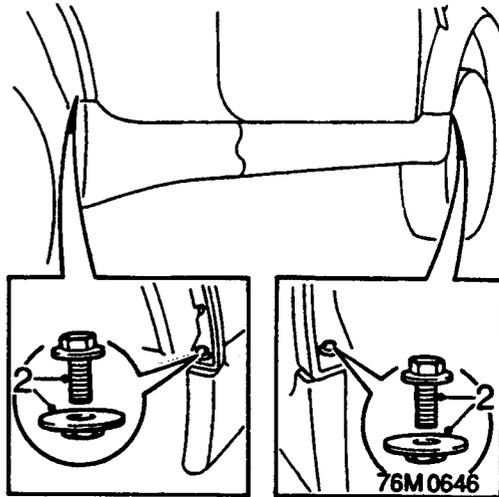

2. Remove 2 nuts and bolts securing sill finishers to front and rear wheel arch finishers.

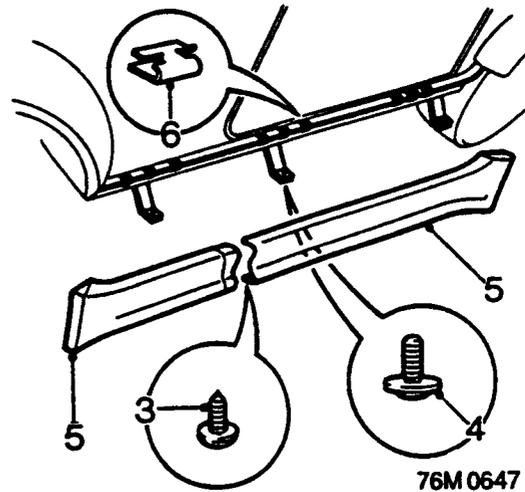

3. Remove screw securing 2 halves of the sill finisher together.
4. Remove 3 screws securing sill finishers to support brackets.
5. Release finishers from 9 clips on body flange, remove finishers.
6. Remove 9 clips securing sill finisher to body flange (either from finisher or flange).



Refit

1. Clean finisher and body flange mating faces.
2. Apply protective wax to body flange where damaged by clips.
3. Fit 9 clips to body flange.
4. Fit rear side finisher to body flange and align to rear wheel arch finisher.
5. Fit front side finisher to body flange and align to rear side finisher and front wheel arch finisher.
6. Fit and tighten screw securing body finishers together.
7. Fit and tighten 2 nuts and bolts securing body side finisher to front and rear wheel arch finishers.
8. Fit and tighten 3 screws securing body side finishers to support brackets.
9. Remove stand(s) and lower vehicle.

REAR WHEEL ARCH FINISHER

Service Repair No. 76.43.55

Remove

1. Raise rear of vehicle.

WARNING: Support on safety stands.

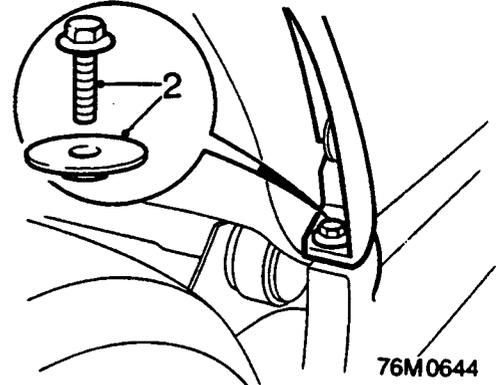

2. Remove nut and bolt securing arch finisher to sill finisher.

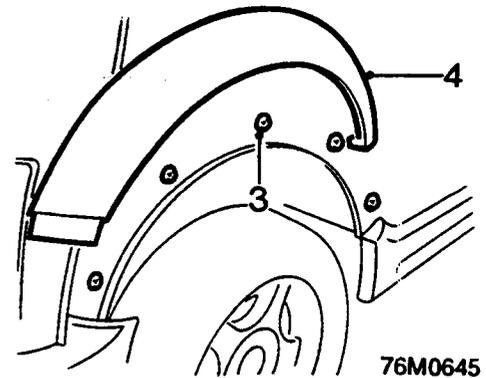

3. Slacken 5 bolts securing wheel arch finisher to body.
4. Remove wheel arch finisher.

Refit

1. Clean finisher and body mating face.
2. Fit finisher to body.
3. Fit and tighten nut and bolt securing arch finisher to sill finisher.
4. Tighten 5 bolts securing arch finisher to body.
5. Remove stand(s) and lower vehicle.

BODY

LH REAR BUMPER

Service Repair No. 76.22.85

Remove

1. Raise rear of vehicle.

WARNING: Support on safety stands.

2. Remove RH rear bumper, see RH rear bumper.

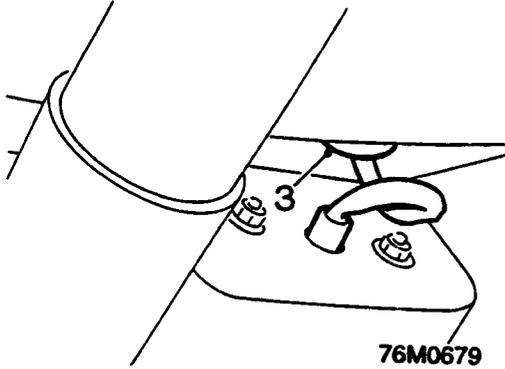

3. Release fog lamp harness grommet from rear quarter panel.

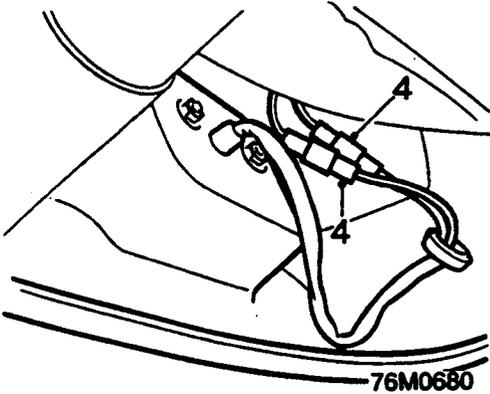

4. Withdraw harness connections out of body panel and disconnect 2 connectors.
5. Release bumper from the centre of the vehicle by pushing it upwards.
6. Remove LH bumper.

Do not carry out further dismantling if component is removed for access only

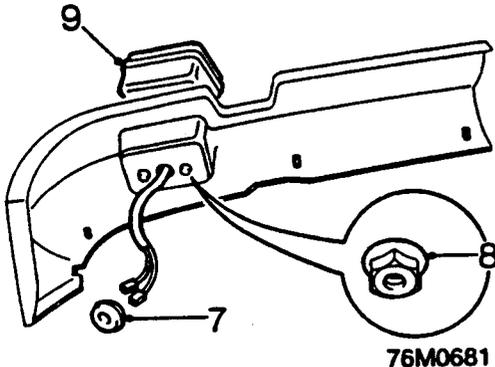

7. Remove grommet from rear fog lamp harness.
8. Remove 2 nuts securing rear fog lamp to bumper.

9. Remove lamp from bumper.
10. Fit rear fog lamp to bumper.
11. Fit and tighten 2 nuts securing lamp.
12. Fit grommet to lamp harness.

Refit

1. Clean mating face of bumper and body flange.
2. Position bumper to body.
3. Connect 2 rear fog lamp connectors to vehicle harness.
4. Position connectors inside body panel and secure grommet to panel.
5. Fit bumper to body.
6. Fit RH half of bumper to body, see RH rear bumper.
7. Remove stand(s) and lower vehicle.



RH REAR BUMPER

Service Repair No. 76.22.86

Remove

1. Raise rear of vehicle.

WARNING: Support on safety stands.

2. Remove RH rear wheel arch finisher, see **Rear wheel arch finisher**.

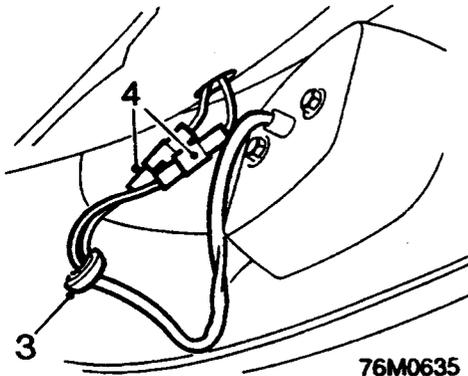

3. Release fog lamp harness grommet from rear quarter panel.
4. Withdraw harness connections out of body panel and disconnect 2 connectors.

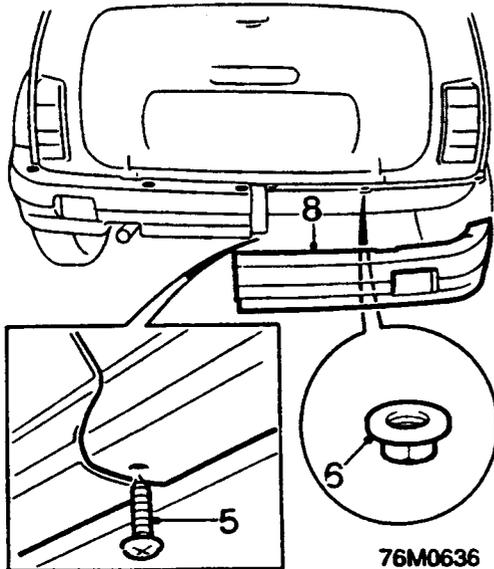

5. Remove screw securing 2 bumper halves together.
6. Remove 6 nuts securing both halves of rear bumper to body flange.
7. Release bumper from the centre of the vehicle by pushing it upwards.
8. Remove RH bumper.

Do not carry out further dismantling if component is removed for access only

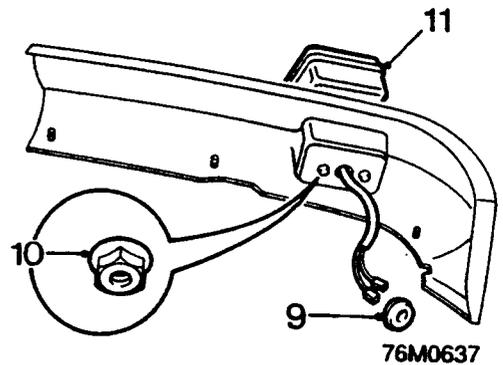

9. Remove grommet from rear fog lamp harness.
10. Remove 2 nuts securing rear fog lamp to bumper.
11. Remove lamp from bumper.
12. Fit rear fog lamp to bumper.
13. Fit and tighten 2 nuts securing lamp.
14. Fit grommet to lamp harness.

Refit

1. Clean mating face of bumper and body flange.
2. Position bumper to body.
3. Connect 2 rear fog lamp connectors to vehicle harness.
4. Position connections inside body panel and secure grommet to panel.
5. Fit bumper to body.
6. Align bumper halves, fit and tighten screw.
7. Fit and tighten 6 nuts securing bumper to body.
8. Fit RH rear wheel arch finisher, see **Rear wheel arch finisher**.
9. Remove stand(s) and lower vehicle.

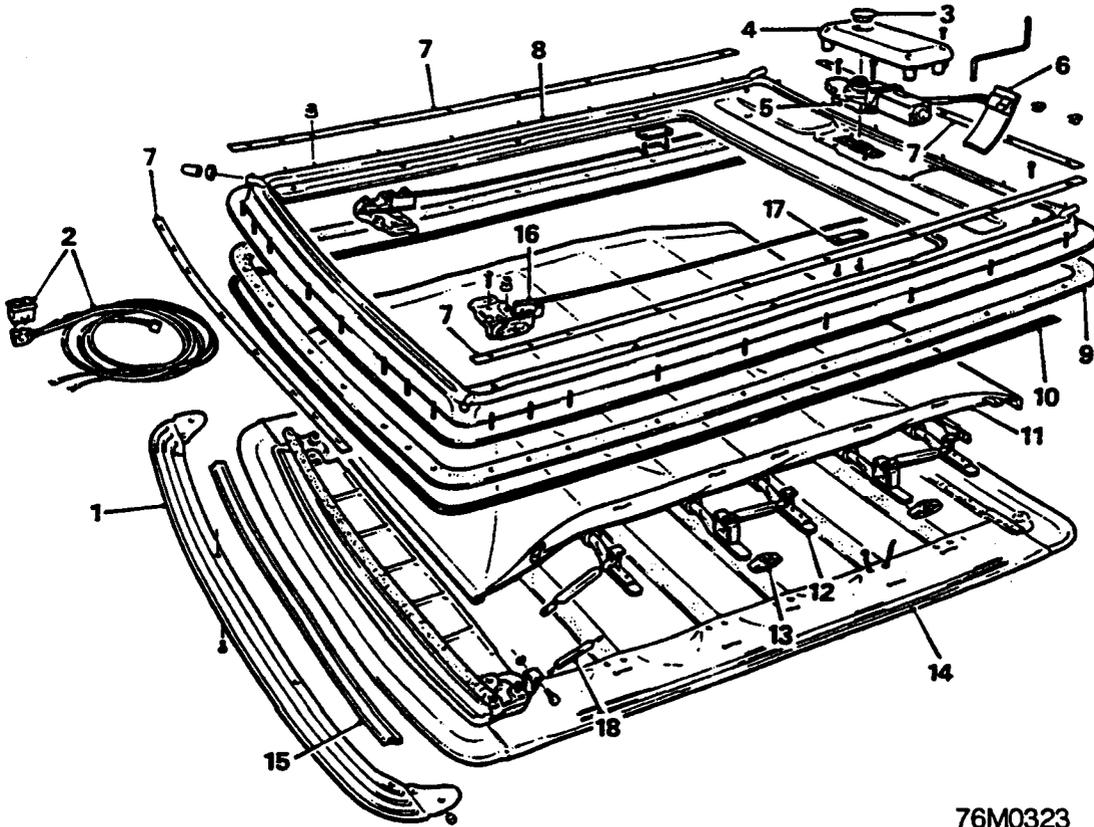

76M0323

FABRIC SUN ROOF COMPONENTS

- | | |
|--------------------------------|----------------------------|
| 1. Wind deflector | 10. Sun roof cover seal |
| 2. Sun roof switch and harness | 11. Inner cover |
| 3. Sun roof motor access cap | 12. Support bars |
| 4. Sun roof motor cover | 13. Slide shoe |
| 5. Sun roof motor | 14. Outer cover |
| 6. Anti-vibration foam strip | 15. Sun roof front seal |
| 7. Roof clamping strips | 16. Drive block and cable. |
| 8. Sun roof cassette | 17. Guide rail plate |
| 9. Sun roof to roof seal | 18. Support bar spring |



SUN ROOF COVER ADJUSTMENT

Service Repair No. 76.61.09

Remove

1. Remove heated rear window, see **Rear window**.

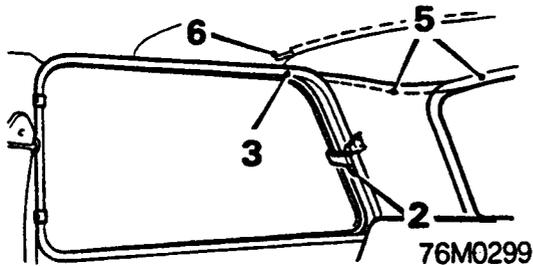

2. Open LH and RH rear quarter lights
3. Release quarter light sealing rubbers from top rear corner of each aperture.
4. Remove sun roof motor access cap.
5. Release headlining from rear window aperture and from behind 'D' post trim panels.
6. Release the headlining support rod from cantrail.

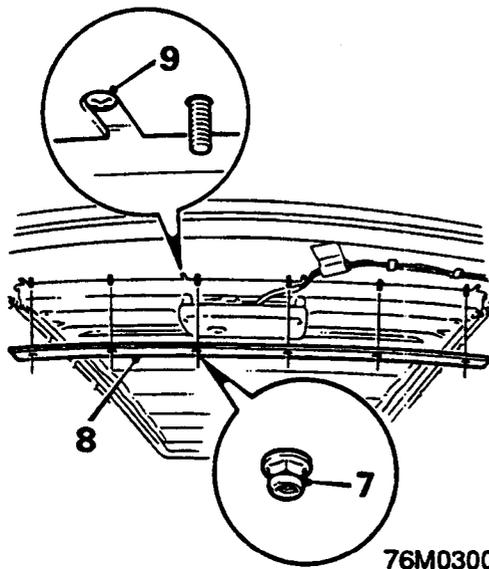

7. Remove 6 nuts securing rear clamping strip to roof.
8. Remove clamping strip.

Adjusting

9. Slacken 4 sun roof adjustment screws.
10. Open sun roof and adjust the position of the outer cover.

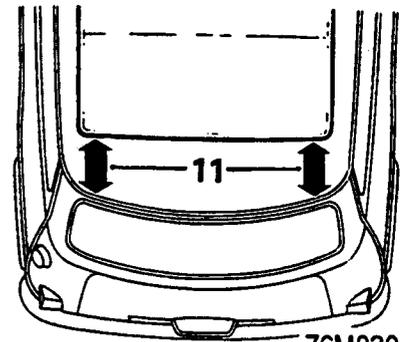

76M0301

11. Measure between the rear edge of the outer cover and the roof drain channel to ensure both sides of the cover have been adjusted equally.
12. Tighten 4 sun roof adjustment screws.
13. Turn starter switch to position 'I'.
14. Open and close sun roof several times checking that the sun roof fully closes and that it does not stick on the front edge of the sun roof cassette when being opened. Check tension of the sun roof inner cover.
15. Turn starter switch to position 'O'.

Refitting

1. Position rear clamping strip to roof, fit nuts and tighten to 4 Nm.
2. Secure headlining support rod to cantrail.
3. Attach double sided tape to edge of the headlining.

CAUTION: Do not remove backing paper from roof attachment side of tape until headlining is positioned.

4. Tension headlining to remove creases and secure headlining to rear quarter light aperture flanges and behind 'D' post trim panels.
5. Secure quarter light aperture flange seal.
6. Close L.H. and R.H. rear quarter lights.
7. Working from the centre of the rear window aperture, tension headlining and secure to flange.
8. Refit sun roof motor access cap.
9. Refit heated rear window, see **Rear window**.

SUN ROOF FRONT SEAL

Service Repair No. 76.82.65

Remove

1. Turn starter switch to position 'I'.
2. Open sun roof to gain access to front seal.

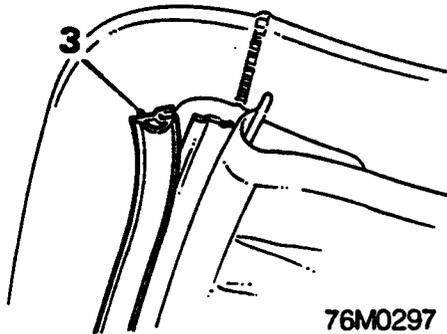

3. Carefully remove sun roof front seal from the outer cover support frame.

Refitting

1. Clean the contact area on the outer cover support frame with a cleaning solvent.
2. Locate the new sun roof front seal in the channel on the outer cover support frame.
3. Remove the backing paper from the sun roof seal and secure to outer cover support frame.
4. Close sun roof.
5. Turn starter switch to position '0'.

WIND DEFLECTOR

Service Repair No. 76.82.31

Remove

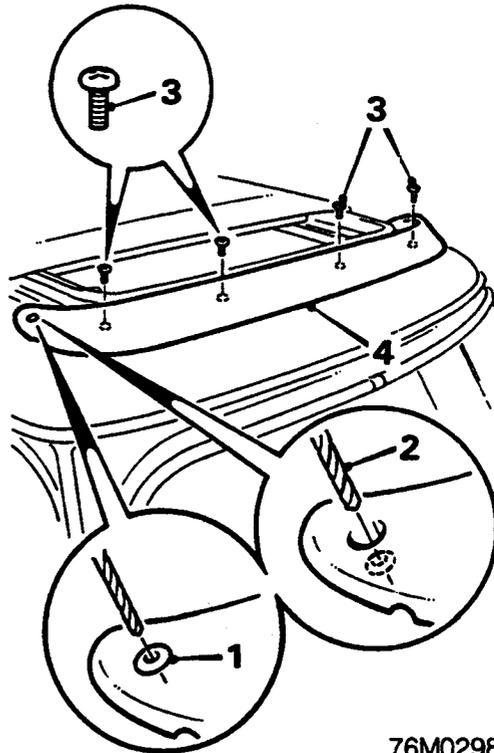

1. Remove 2 cover plugs by drilling a 3 mm hole through them and levering out with a small screwdriver.

Early models

2. Using 4 mm drill bit, drill out 2 end fixing rivets.
3. Remove 4 screws, securing wind deflector to roof.
4. Remove wind deflector.

Later models

5. Open sun roof and release seal finisher from front edge of aperture.
6. Release headlining from front edge of sun roof aperture.
7. Remove 6 nuts and bolts securing wind deflector to roof.
8. Remove wind deflector.

Refit

1. Apply wax to edge of fixing holes.

Early models

2. Align wind deflector to captive nuts, and secure with screws.
3. Rivet the ends of the wind deflector to the roof.
4. Fit 2 new cover plugs.

Later models

5. Align wind deflector to roof
6. Fit and tighten nuts and bolts.



7. Attach double sided tape to the edge of the headlining.
8. Position headlining to front edge of sun roof aperture.
9. Remove backing paper from double sided tape and secure headlining to sun roof aperture flange.
10. Close sun roof.
11. Fit 2 new cover plugs.

SUN ROOF SWITCH

Service Repair No. 76.82.59

Remove

1. Open sun roof.

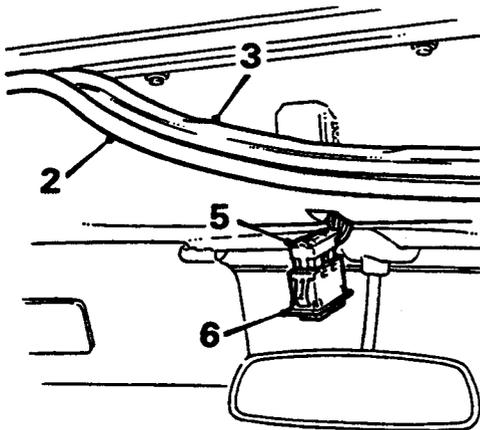

76M0302

2. Release seal finisher from front edge of sun roof aperture.
3. Carefully release headlining from front edge of sun roof aperture.
4. Release 2 clips securing switch to roof bracket.
5. Disconnect switch multiplug.
6. Remove switch.

Refit

1. Connect multiplug to switch.
2. Attach double sided tape to the edge of the headlining.
3. Position headlining to front edge of sun roof aperture.
4. Remove packing paper from double sided tape and secure headlining to sun roof aperture flange.
5. Reposition and secure seal finisher to front edge of sun roof aperture.
6. Position switch and secure into roof bracket.
7. Close sun roof.

SUN ROOF MOTOR

Service Repair No. 76.82.53

Remove

1. Remove rear window, see Rear window.

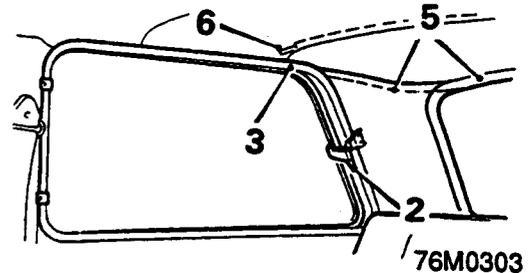

76M0303

2. Open LH and RH rear quarter lights.
3. Release quarter light sealing rubbers from top rear corner of each aperture.
4. Remove sun roof motor access cap.
5. Release headlining from rear window aperture and from behind 'D' post trim panels.
6. Release the headlining support rod from cantrail.

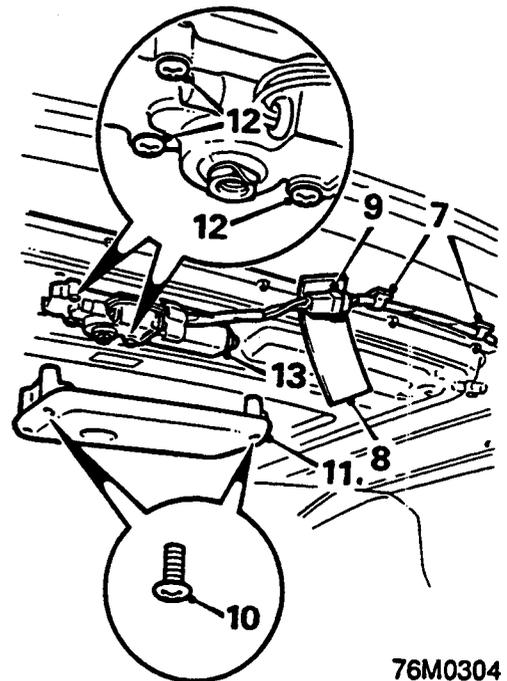

76M0304

7. Release motor harness from 2 clips on roof panel.
8. Remove the anti-vibration foam strip from motor harness multiplug.
9. Disconnect motor harness multiplug.
10. Remove 4 screws securing motor cover to motor.
11. Remove motor cover.
12. Remove 3 screws securing motor to sun roof assembly.
13. Remove motor.

BODY

Refit

1. Position motor to sun roof assembly, fit and tighten screws.
2. Position motor cover and secure with screws.
3. Reconnect motor harness multiplug.
4. Remove backing tape from new anti-vibration foam strip. Wrap foam strip around motor harness multiplug.
5. Secure motor harness to roof clips.
6. Secure headlining support rod to cantrail.
7. Attach double sided tape to the edge of the headlining.

CAUTION: Do not remove backing paper from roof attachment side of tape until headlining is positioned.

8. Tension headlining to remove creases and secure headlining to rear quarter light aperture flanges and behind 'D' post trim panels.
9. Secure quarter light aperture flange seal.
10. Close LH and RH rear quarter lights.
11. Working from the centre of the rear window aperture, tension headlining and secure to flange.
12. Refit sun roof motor access cap.
13. Refit rear window, see **Rear window**.

SUN ROOF COVERS

Service Repair No.

Outer cover: 76.61.11

Inner cover: 76.61.13

Remove

1. Turn starter switch to position 'I'.
2. Open sun roof approximately 200 mm.
3. Turn starter switch to the '0' position.
4. Remove rear window, see **Rear window**.

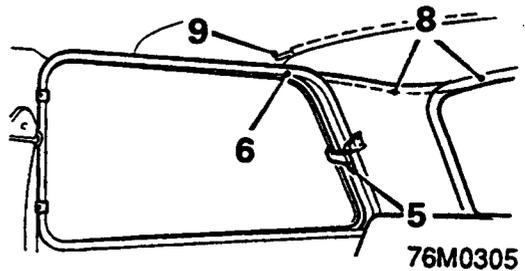

5. Open L.H. and R.H. rear quarter lights.
6. Release quarter light sealing rubbers from top rear corner of aperture.
7. Remove sun roof motor access cap.
8. Release headlining from rear window aperture and from behind 'D' post trim panels.
9. Release the headlining support rod from cantrail.

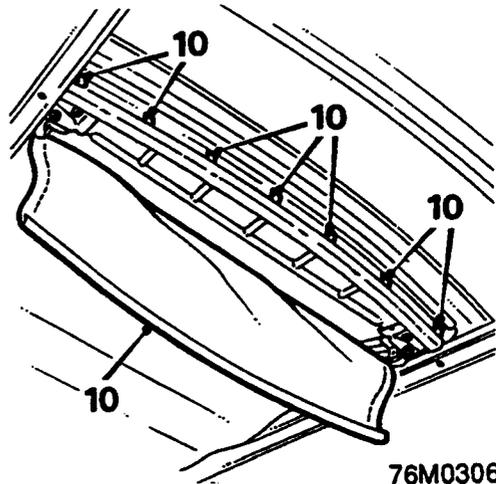

10. Push front of sun roof inner cover upwards to release from securing clips on frame.

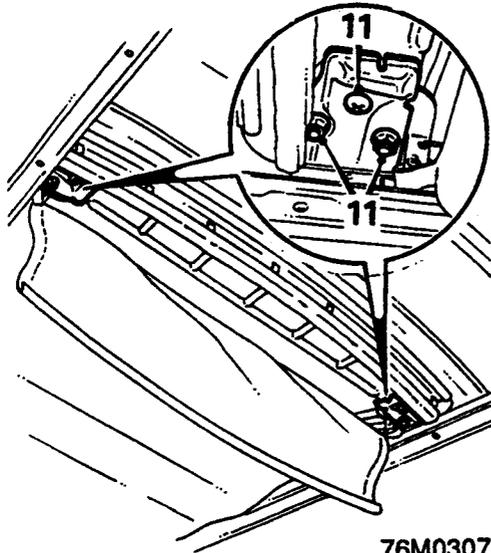

76M0307

- 11. Remove 2 screws and 4 nuts securing cover assembly to drive cable blocks.

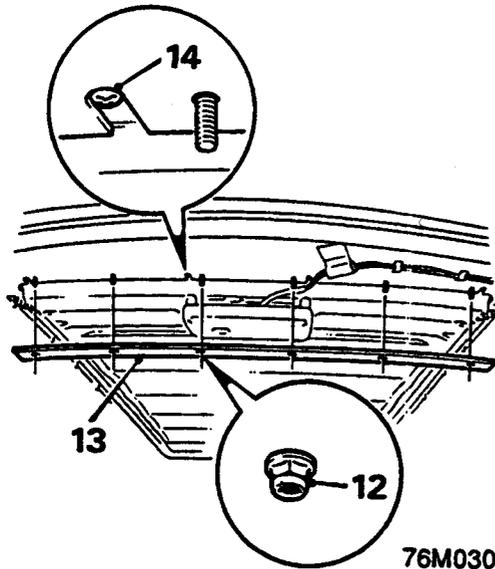

76M0308

- 12. Remove 6 nuts securing rear clamping strip to roof.
- 13. Remove clamping strip.
- 14. Remove 4 sun roof adjustment screws.
- 15. Fold outer cover back on itself and push sun roof assembly forward to gain access to guide rail plates.

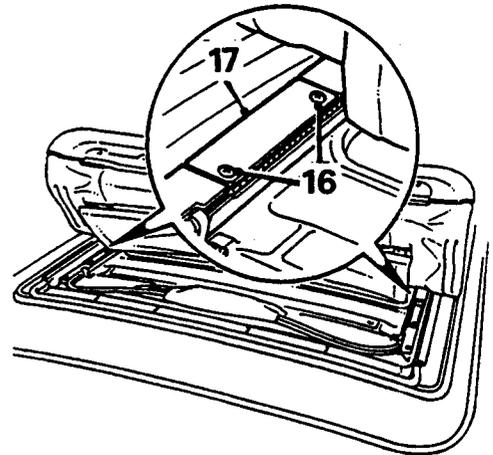

76M0309

- 16. Remove 4 screws securing guide rail plates.
- 17. Remove guide rail plates.

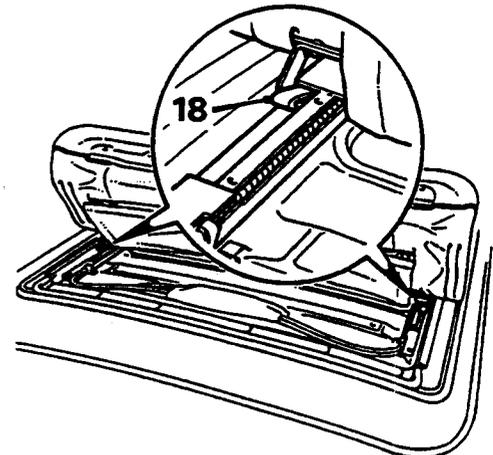

76M0310

- 18. Working from the rear of car, slide cover assembly rearwards and release slide shoes from guide rails.
- 19. Remove cover assembly from car.

Note: Lay sun roof assembly on a clean table, outer cover side down.

BODY

Do not carry out further dismantling if component is removed for access only

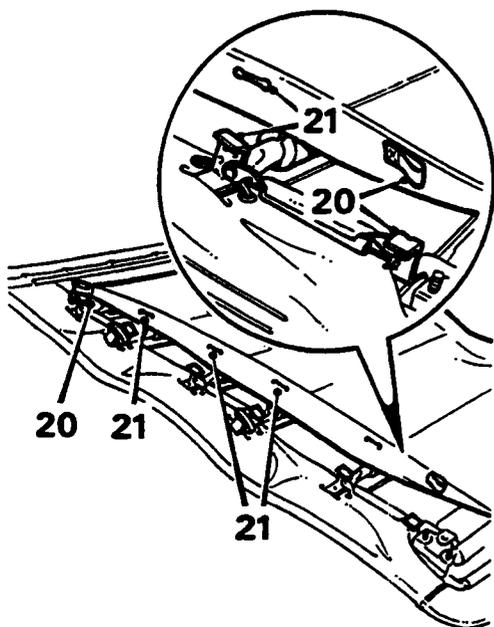

76M0311

20. Release inner cover straps from outer cover support frame.
21. Release inner cover from the ends of the support bars.

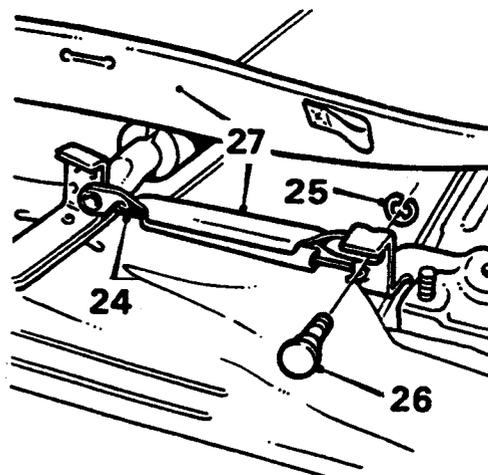

76M0313

24. Release and remove 2 springs connecting inner cover support bars to outer cover support frame.
25. Remove 2 circlips from pins securing inner cover support bars to outer cover support frame.
26. Remove 2 pins.
27. Remove inner cover and support bars from outer cover.

Note: If the outer cover is to be replaced the sun roof front seal will have to be carefully removed from the outer cover support frame and fitted to new cover.

Refit

1. Position inner cover and support bars to outer cover.
2. Fit pins securing inner cover support bars to outer cover support frame.
3. Fit circlips to pins.
4. Fit springs between support bars and frame.
5. Fit outer cover to support bar ends and secure with new cable ties.
6. Secure inner cover to ends of support bars and the inner cover straps to the outer cover support frame.
7. Using assistance position the cover assembly to sun roof cassette and locate the slide shoes into the guide rails.
8. Push the cover assembly forward and fit the 2 guide rail plates, secure with screws.
9. Position rear of outer cover, align and fit 4 sun roof adjustment screws.

Note: Tighten screws with the cover in the fully forward position on the holes.

10. Position rear clamping strip to roof, fit nuts and tighten to 4 Nm.
11. Align front of cover assembly to drive cable blocks, fit and tighten 4 nuts and 2 screws.
12. Secure front of inner cover to clips on frame.
13. Check and adjust sun roof cover, see **Sun roof cover adjustment**.
14. Secure headlining support rod to cantrail.

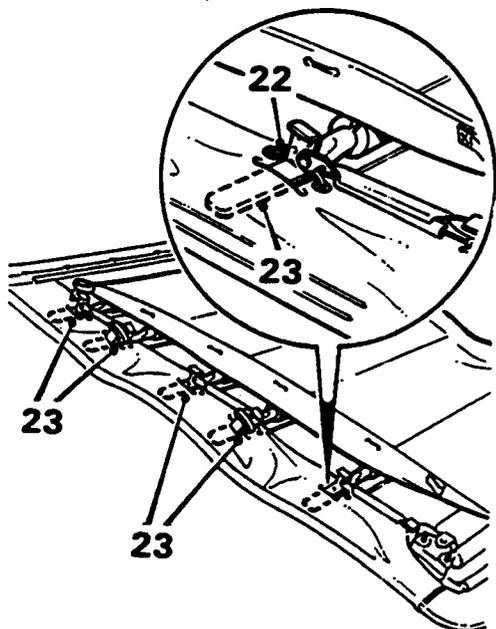

76M0312

22. Cut cable ties securing outer cover to support bars.
23. Release outer cover from the ends of the support bars.



- Attach double sided tape to edge of the headlining.

CAUTION: Do not remove backing paper from roof attachment side of tape until headlining is positioned.

- Tension headlining to remove creases and secure headlining to rear quarter light aperture flanges and behind 'D' post trim panels.
- Secure quarter light aperture flange seal.
- Close LH and RH rear quarter lights.
- Working from the centre of the rear window aperture, tension headlining and secure to flange.
- Refit sun roof motor access cap.
- Refit rear window, see **Rear Window**.

SUN ROOF SLIDE SHOES

Service Repair No. 76.82.66

Remove

- Remove sun roof cover assembly, see **Sun roof covers**

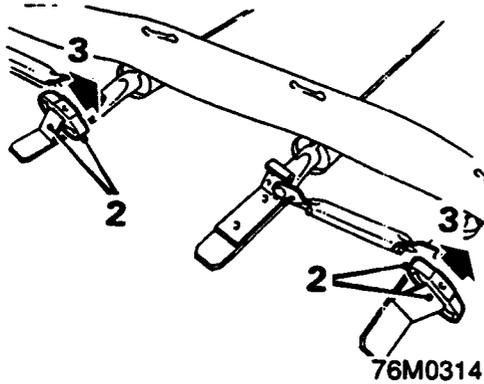

- Insert a flat blade between the RED slide shoe and the inner cover support bar.
- Pull the slide shoes from the support bars.

Refit

- Fit new slide shoes to support bars.
- Refit sun roof cover assembly, see **Sun roof covers**.

SUN ROOF DRIVE CABLE

Service Repair No. 76.82.14

Remove

- Remove sun roof cover assembly, see **Sun roof covers**.
- Remove sun roof motor, see **Sun roof motor**.

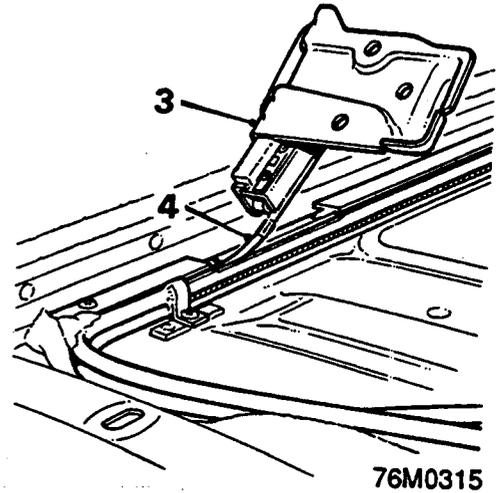

- Slide drive cable block back so that it can be removed through the cut away in the guide rail.
- Release drive cable block from guide rail and withdraw drive cable from cable guide.

Refit

- Lightly grease drive cable with petroleum jelly.
- Feed drive cable into cable guide.

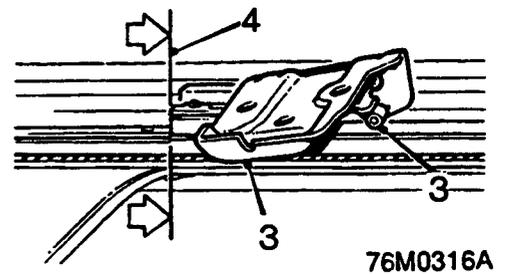

- Fit drive cable block into guide rail.

Note: The front roller on the drive cable block runs on top of guide rail.

- Align back edge of both drive cable blocks to front edge of guide rail cutaways.
- Fit sun roof motor, see **Sun roof motor**.
- Fit sun roof cover assembly, see **Sun roof cover**.

SUN ROOF COVER SEAL

Service Repair No. 76.82.15

Remove

1. Remove sun roof cover assembly, see **Sun roof covers**.

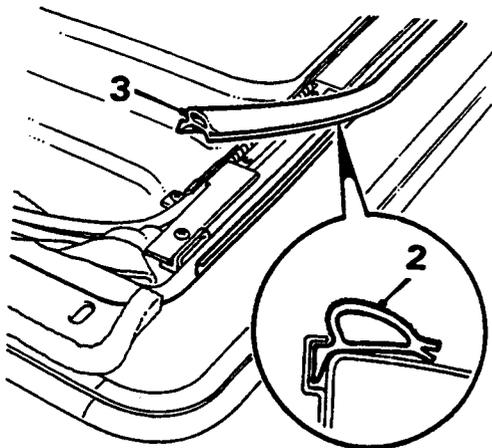

76M0317

2. Release sun roof cover seal from channel on sun roof.
3. Remove sun roof cover seal.

Refit

1. Remove backing strip from new sun roof cover seal.
2. Position sun roof cover seal and secure to sun roof.
3. Fit sun roof cover assembly, see **Sun roof covers**.

SUN ROOF

Service Repair No. 76.82.56

Remove

1. Turn starter switch to position 'I'.
2. Fully open sun roof.
3. Turn starter switch to position '0'.
4. Remove rear window, see **Rear window**.

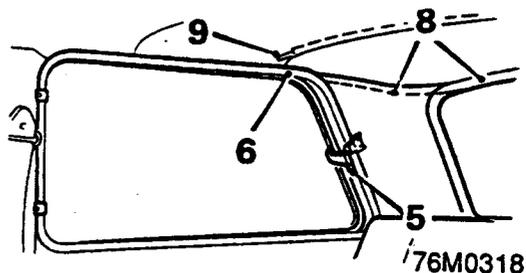

76M0318

5. Open LH and RH rear quarter lights.
6. Release quarter light sealing rubbers from top rear corner of aperture.
7. Remove sun roof motor access cap.
8. Release headlining from rear window aperture and from behind 'D' post trim panels.
9. Release the headlining support rod from cantrail.

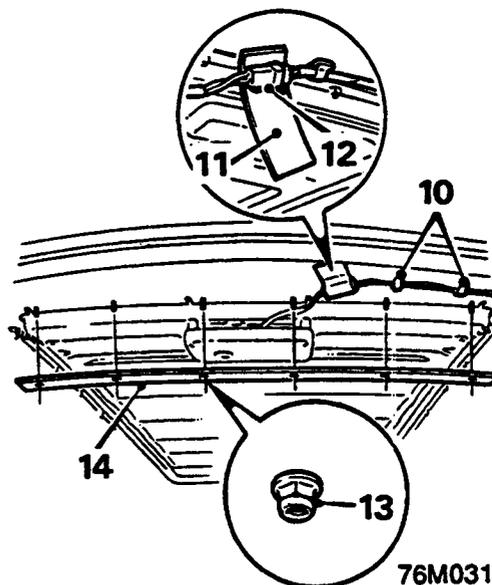

76M0319

10. Release motor harness from 2 clips on roof panel.
11. Remove the anti-vibration foam strip from motor harness multiplug.
12. Disconnect motor harness multiplug.
13. Remove 6 nuts securing rear clamping strip to roof.
14. Remove clamping strip.
15. Remove seal finisher from sun roof aperture.
16. Carefully release headlining from sun roof aperture flange.

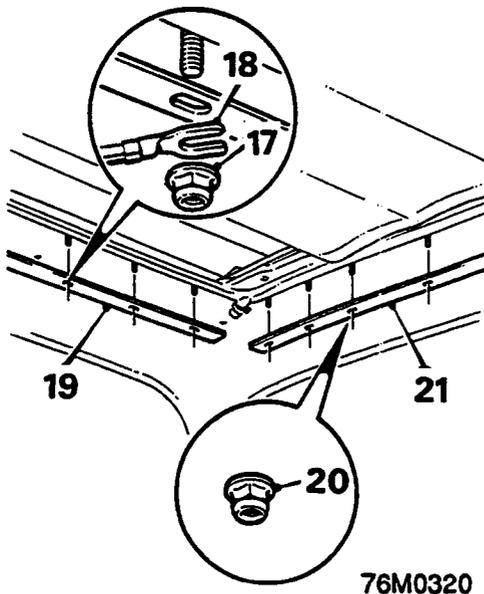

17. Remove 8 nuts securing front clamping strip to roof.
18. Release earth eyelet from sun roof stud.
19. Remove clamping strip.
20. Remove 18 nuts securing LH and RH clamping strips to roof.
21. Remove clamping strips.

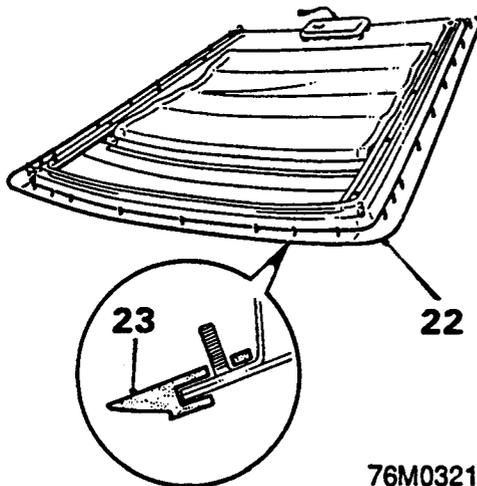

22. Remove sun roof assembly from vehicle.
Do not carry out further dismantling if component is removed for access only
23. Remove roof seal from sun roof.
24. Clean contact face, remove backing paper from new seal, position and secure new seal.

Refitting

1. Position sun roof assembly to roof panel.
2. Align sun roof studs with holes in roof panel.
3. Position LH and RH clamping strips to roof, fit nuts and tighten to 4 Nm.
4. Position rear clamping strip to roof, fit nuts and tighten to 4 Nm.
5. Position front clamping strip to roof, fit earth eyelet to sun roof stud. Fit nuts and tighten to 4 Nm
6. Reconnect motor harness multiplug.

7. Remove backing tape from new anti - vibration foam strip. Wrap foam strip around motor harness multiplug.
 8. Secure motor harness to roof clips.
 9. Secure headlining support rod to cantrail.
 10. Attach double sided tape to the edge of the headlining.
- CAUTION:** Do not remove backing paper from roof attachment side of tape until headlining is positioned.
11. Tension headlining to remove creases and secure headlining to sun roof aperture.
 12. Fit sun roof aperture seal finisher.
 13. Tension headlining and secure to rear quarter light apertures and behind 'D' post trim panels.
 14. Secure quarter light aperture flange seal.
 15. Close LH and RH rear quarter lights. -
 16. Working from the centre of the rear window aperture, tension headlining and secure to flange.
 17. Refit sun roof motor access cap.
 18. Refit rear window, see **Rear window**.

BODY

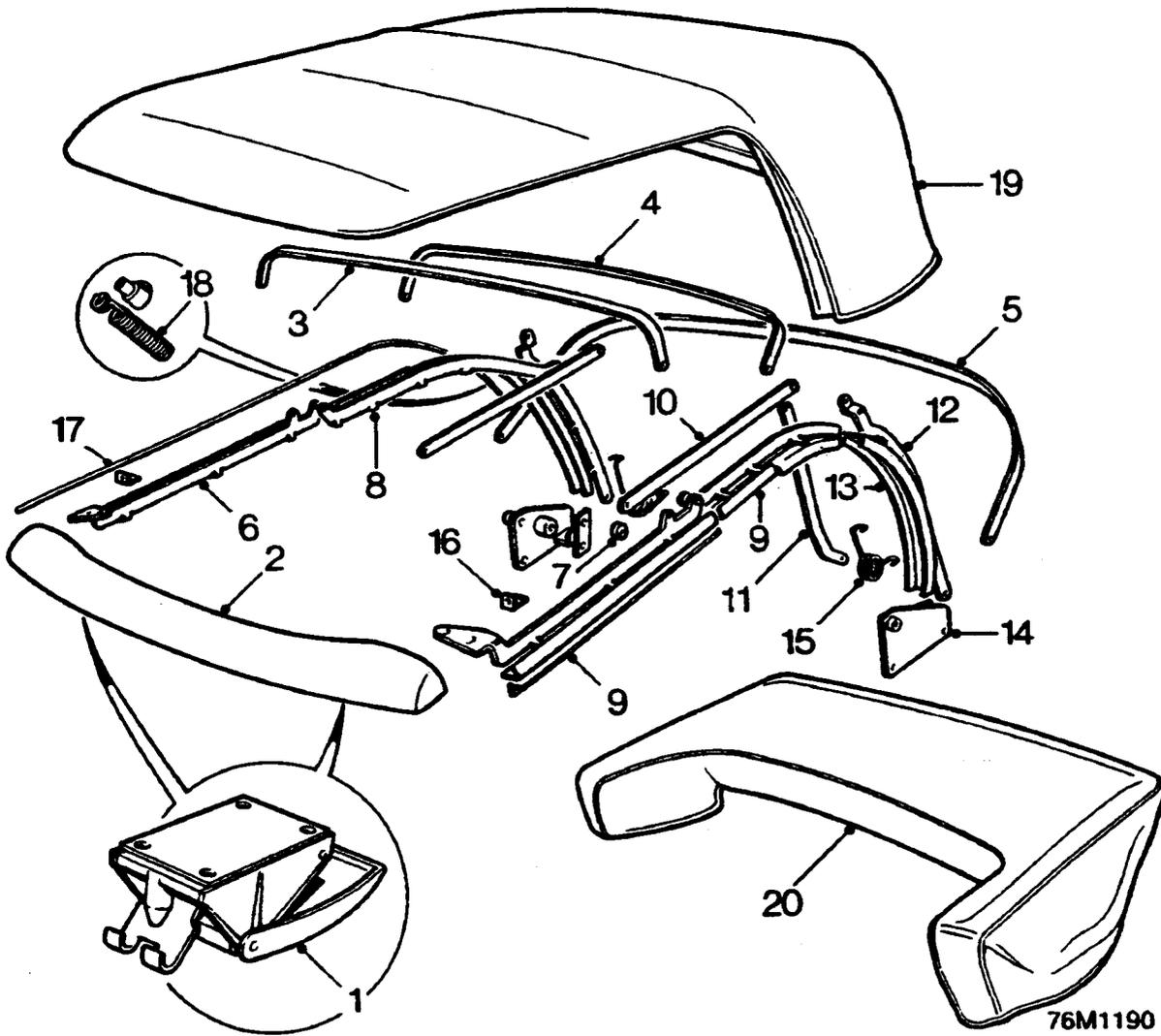

CABRIOLET HOOD COMPONENTS

- | | |
|--------------------------|--------------------------------------|
| 1. Hood catch | 12. 'D' post rail |
| 2. Header rail | 13. 'D' post seal retainer |
| 3. Front hood rail | 14. Frame pivot/mounting bracket |
| 4. Central hood rail | 15. Pivot spring |
| 5. Rear retainer rail | 16. Cantrail cable bracket |
| 6. Side rail - Front | 17. Cantrail cable |
| 7. Height adjustment cam | 18. Cantrail cable tensioning spring |
| 8. Side rail - Rear | 19. Hood cover |
| 9. Seal carrier | 20. Tonneau cover |
| 10. Rear folding arm | |
| 11. 'D' post folding arm | |



HOOD CATCHES

Service Repair No. 76.61.50

Remove

1. Release hood catches and lower hood.

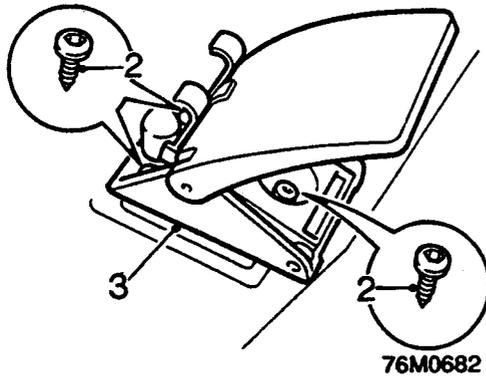

2. Remove 3 Allen screws (4 mm) securing catch to header rail.
3. Remove hood catch.

Refit

1. Position hood catch to header rail, fit Allen screws finger tight.
2. Raise hood and secure catches.
3. Release hood catches and lower hood before tightening Allen screws.

HOOD HANDLE

Service Repair No. 76.61.57

Remove

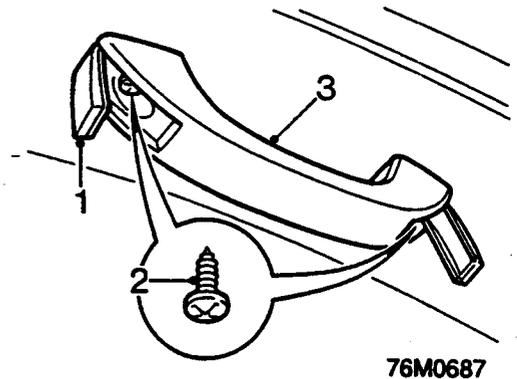

1. Release screw covers from handle.
2. Remove 2 screws securing handle to header rail.
3. Remove handle.

Refit

1. Fit handle to header rail.
2. Secure handle to header rail with screws.
3. Secure screw covers.

BODY

HEADER SEAL

Service Repair No. 76.61.35

Remove

1. Lower both rear windows.
2. Release hood catches and lower hood.
3. Place protective covering between header rail and outer covering.

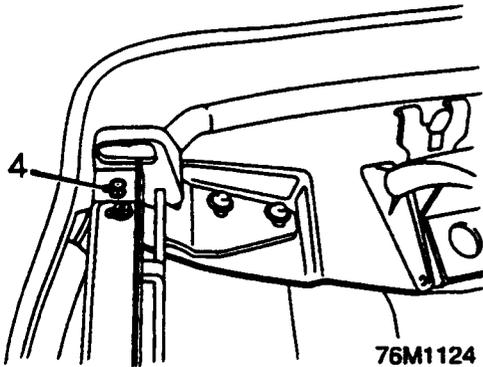

4. Drill out 4 rivets securing ends of header seal to hood frame.

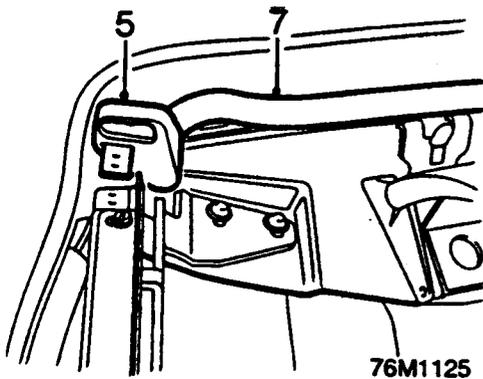

5. Release header seal brackets from frame.
6. Remove protective covering.
7. Release seal from retainer and remove header seal.

Refit

1. Apply liquid soap to retainer and new seal.
2. Fit header seal to retainer.
3. Locate brackets in ends of header seal to frame and align rivet holes. Centralise header seal to retainer if necessary.
4. Secure seal ends to frame with pop rivets.
5. Wipe off excess soap from seal and header rail.
6. Raise hood and secure hood handles.

CANTRAIL TENSIONING CABLE

Service Repair No. 76.61.26

Remove

1. Lower both rear windows.
2. Release hood catches and lower hood.

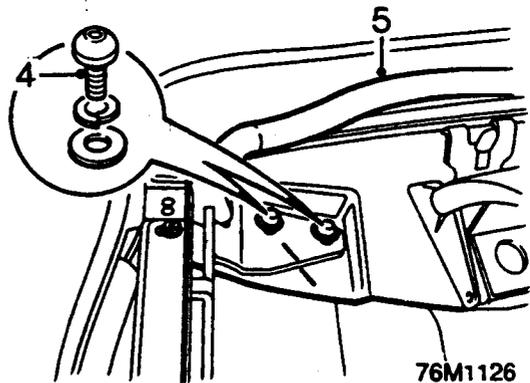

3. Mark relationship of frame to header rail.
4. Remove 2 Allen screws securing relevant side of header rail to hood frame.
5. Release 150 mm of header seal from frame on relevant side of hood.

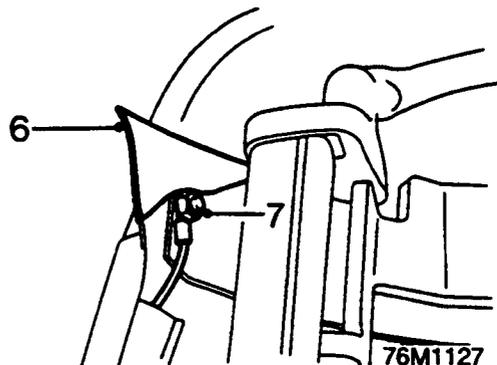

6. Release header rail from frame and peel away outer covering to expose cable fixing.
7. Remove nut securing cable to header rail and release cable from stud.
8. Raise hood partially.

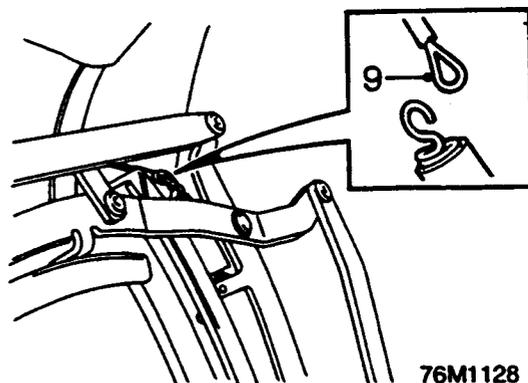

9. Release rear end of cable from tensioning spring.
10. Tie draw string to end of cable and withdraw cable from outer covering. Untie draw string, but leave routed through hood.



Refit

1. Attach new cable to tensioning spring.
2. Tie draw string to cable, draw cable into outer covering and untie draw string.
3. Lower hood fully.
4. Align cable loop to header rail stud and secure with nut.
5. Apply adhesive to header rail and mating face of outer covering.
6. Carefully bond outer covering to header rail, ensuring that beaded edge follows contour of header rail.

Note: Use a Neoprene based adhesive, such as Dunlop 758, and allow to cure for between 5 and 10 minutes before making the bond.

7. Align header rail to marks on frame and secure with Allen bolts.
8. Secure header seal in retainer.
9. Raise hood and secure catches.
10. Raise rear windows.

HOOD ASSEMBLY

Service Repair No. 76.61.10/99

Remove

1. Fully lower both rear windows and remove both rear quarter trim panels, see **Rear quarter trim panel**.
2. Release hood handles and partially lower hood.

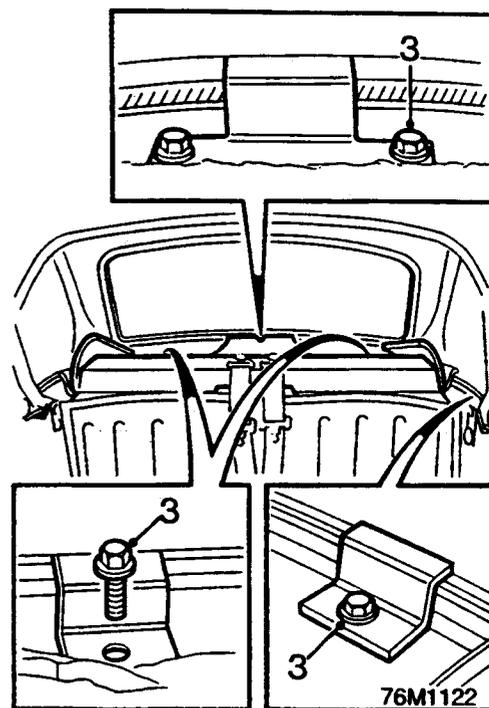

3. Remove 6 bolts securing hood rear retainer rail to rear shelf.
4. Lower hood fully.

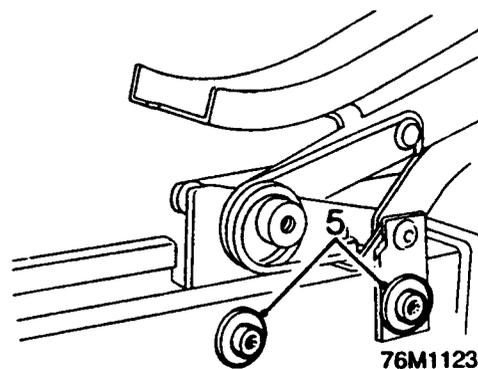

5. Remove 4 bolts securing hood frame to body.
6. With assistance, lift and remove hood assembly.

BODY

Refit.

1. With assistance, fit hood assembly and align mountings to body.
2. Fit frame mounting bolts and tighten to 25 Nm.
3. Partially raise hood.
4. Fit bolts securing hood to rear shelf and tighten to 10 Nm.
5. Fit rear quarter trim panels, see **Rear quarter trim panel**.
6. Raise hood and secure hood handles.
7. Raise rear windows.

HOOD FRAME

Service Repair No. 76.61.12

Remove

1. Lower front and rear windows.
2. Remove both rear quarter trim panels, see **Rear quarter trim panel**.

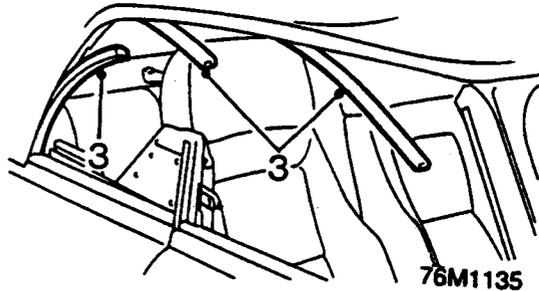

3. Remove hood side seals.
4. Release hood handles and partially lower hood.

Note: Assistance may be necessary to hold hood frame in partially lowered position.

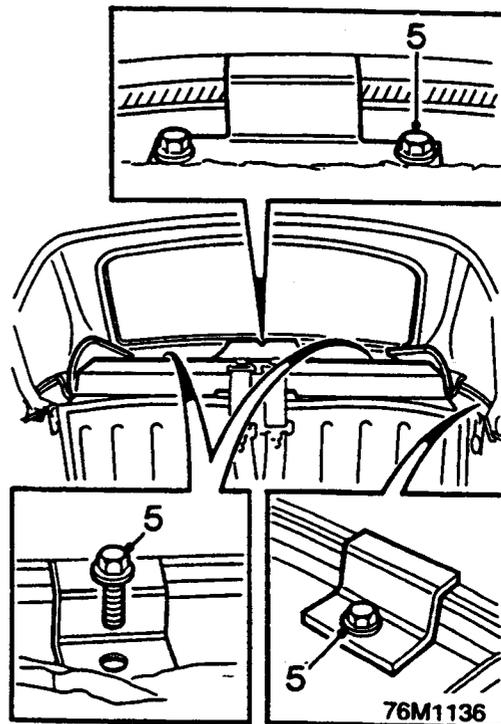

5. Remove 6 bolts securing rear retainer to rear shelf.
6. Place protective covering over rear shelf.

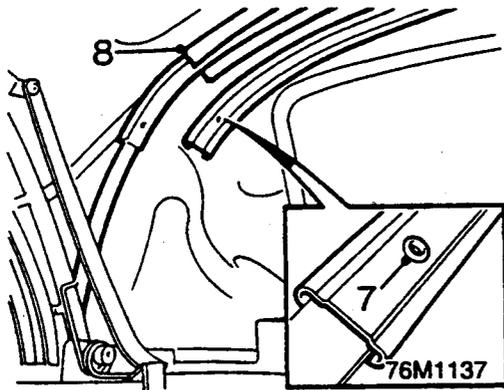

- 7. Drill out 3 pop rivets securing finisher to rear hood spar and remove finisher.
- 8. Release outer cover from adhesive on rear hood spar.

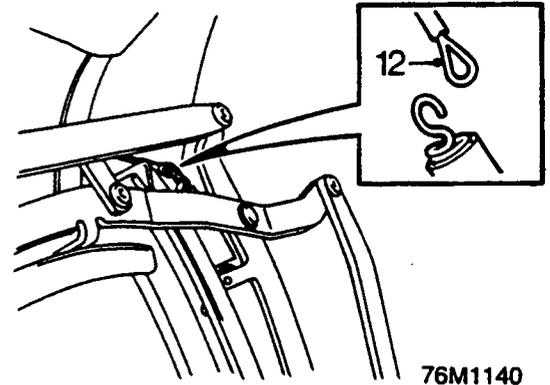

- 12. Release rear end of each cantrail cable from tensioning springs.
- 13. Fully lower hood.

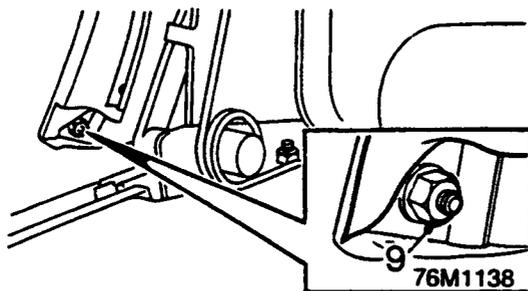

- 9. Remove nuts securing hood outer covering to base of 'D' post brackets.

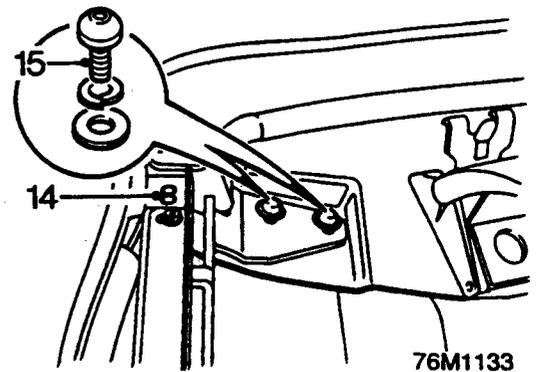

- 14. Drill out 4 pop rivets securing header seal brackets to hood frame.
- 15. Remove 4 Allen screws securing header rail to hood frame.

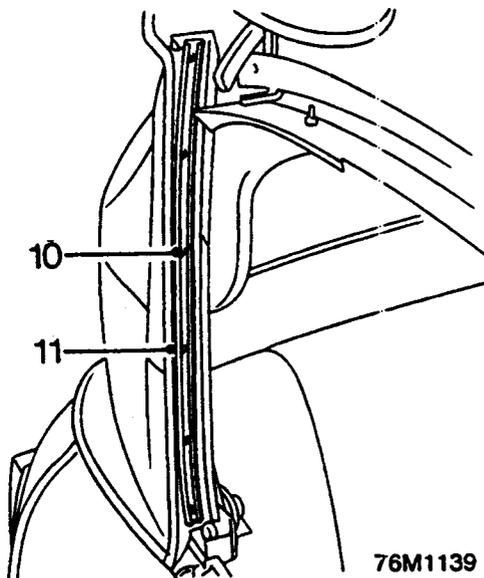

- 10. Drill out 6 pop rivets securing seal retainer to 'D' post brackets and remove retainers.
- 11. Release outer covering from adhesive on 'D' post areas of hood frame.

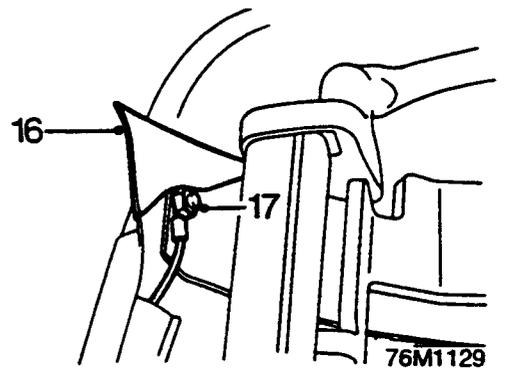

- 16. Release header rail from frame and peel away outer covering to expose cantrail cable fixings.
- 17. Remove nut securing cable to header rail and release cable from stud.

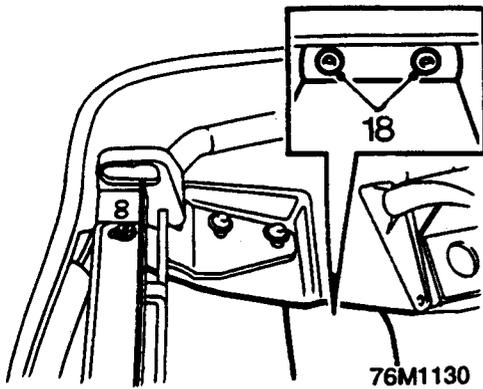

18. With assistance, drill out 2 pop rivets securing each elastic strap and release straps from header rail.
19. Raise hood.

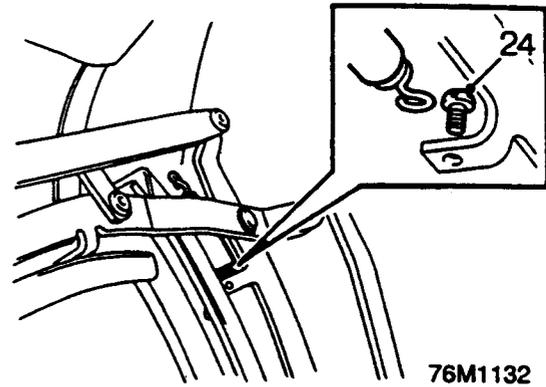

24. Remove screws and remove cantrail cable tensioning springs from frame.

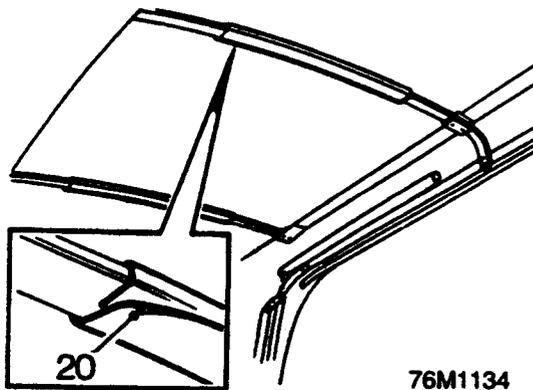

20. Release outer covering from adhesive on forward and central hood spars.
21. Remove outer covering from hood frame complete with header rail and rear retainer.

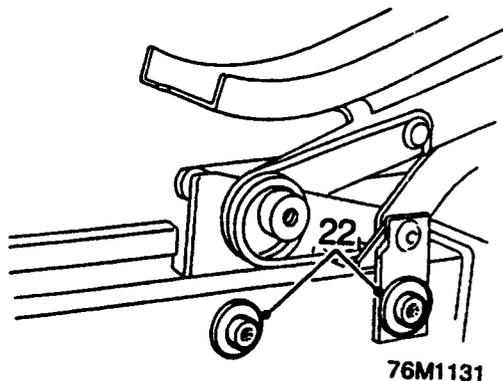

22. Remove 4 bolts securing hood frame to body.
23. With assistance, lift and remove hood frame.

Refit

1. Position cantrail cable tensioning springs to new frame and secure with screws.
2. With assistance, position hood frame to body. Fit frame mounting bolts and tighten to 25 Nm.
3. With assistance, position hood outer covering assembly to body and secure elastic straps to header rail using pop rivets.
4. Align cantrail cable loop to header rail stud and secure with nut.
5. Apply adhesive to header rail and mating face of outer cover.
6. Carefully bond outer covering to header rail, ensuring that beaded edge follows the contour of header rail.

Note: Use a Neoprene based adhesive, such as Dunlop 758, and allow to cure for between 5 and 10 minutes before making the bond.

7. Position header rail to frame, fit and tighten Allen screws centrally in slotted mountings.
8. Position header seal end brackets to hood frame and secure with rivets.
9. Partially raise hood frame.
10. Attach cantrail cables to tensioning springs.
11. Fit bolts securing hood rear retaining rail to rear shelf and tighten to 10 Nm.
12. Raise hood and secure catches.
13. Align hood spars to outer covering.
14. Centralise outer covering on hood frame.
15. Apply adhesive to each hood spar and mating areas of outer covering. Carefully bond outer covering to hood spars.

Note: Use a Neoprene based adhesive, such as Dunlop 758, and allow to cure for between 5 and 10 minutes before making the bond.

Note: Assistance may be necessary to hold hood spars in position as adhesive is applied and bond is made. Use card to protect outer covering during application of adhesive.

16. Position finisher to rear hood spar and drill the holes for the pop rivets through finisher into spar.



CAUTION: DO NOT drill through both walls of rear spar.

17. Secure finisher to rear spar with pop rivets.
18. Apply adhesive to 'D' post brackets and mating areas of outer covering.

Note: Use a Neoprene based adhesive, such as Dunlop 758, and allow to cure for between 5 and 10 minutes before making the bond.

19. Fit and tighten nuts securing outer covering to 'D' post brackets.
20. Apply uniform tension to outer covering and make a temporary bond in three small areas along length of each 'D' post bracket.
21. Check hood rear quarters for creases and adjust cover to 'D' post fit as necessary before making final bond.
22. Align seal retainers to 'D' post brackets and pop rivet in place.
23. Fit hood side seals.
24. Fit rear quarter trim panels, see **Rear quarter trim panel.**

HOOD COVER

Service Repair No. 76.61.11

Remove

1. Lower front and rear windows.
2. Remove both rear quarter trim panels, see **Rear quarter trim panel.**

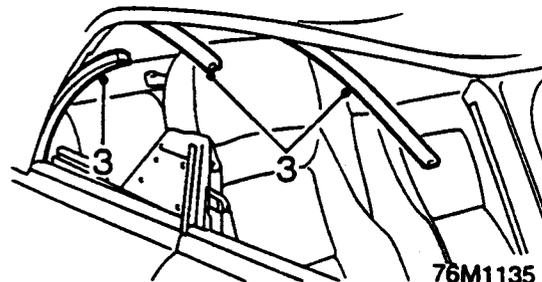

3. Remove hood side seals.
4. Release hood handles and partially lower hood.

Note: Assistance may be necessary to hold hood frame in partially lowered position.

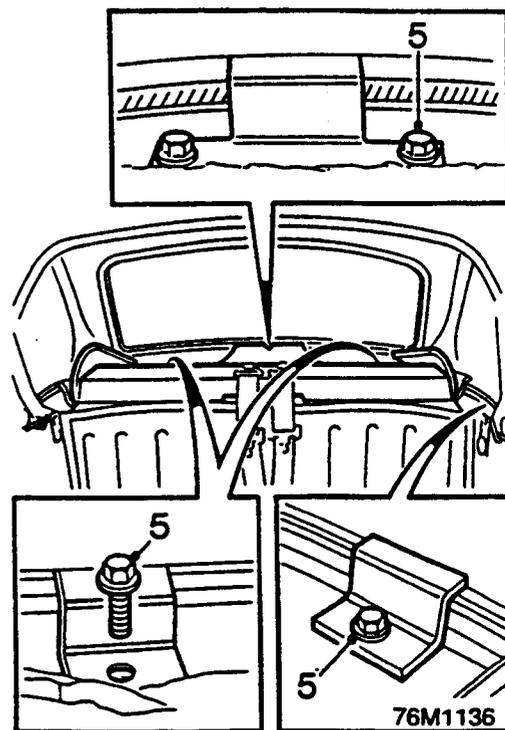

5. Remove 6 bolts securing rear retainer to rear shelf.
6. Place protective covering over rear shelf.

BODY

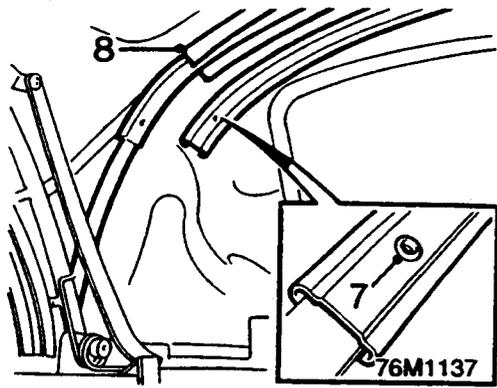

7. Drill out 3 pop rivets securing finisher to rear hood spar and remove finisher.
8. Release outer cover from adhesive on rear hood spar.

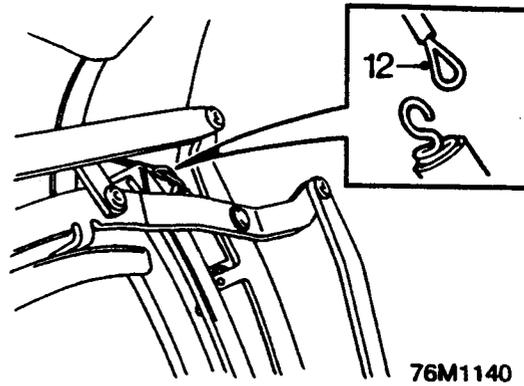

12. Release rear end of each cantrail cable from tensioning springs.
13. Fully lower hood.

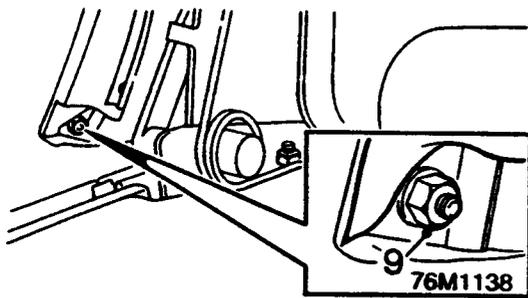

9. Remove nuts securing hood outer covering to base of 'D' post brackets.

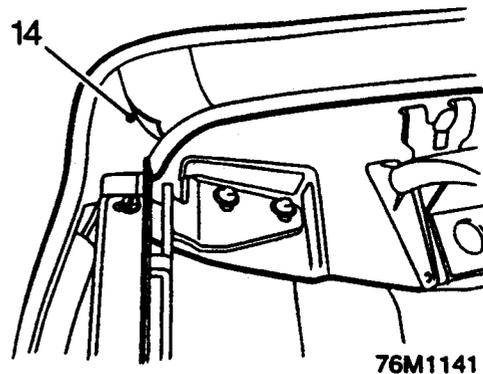

14. Release outer cover from adhesive on header rail.
15. Withdraw cantrail cables from outer cover.
16. Raise hood.

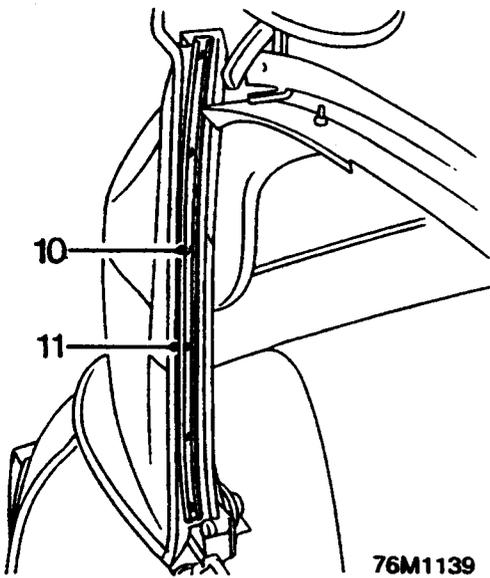

10. Drill out 6 pop rivets securing seal retainer to 'D' post brackets and remove retainers.
11. Release outer covering from adhesive on 'D' post areas of hood frame.

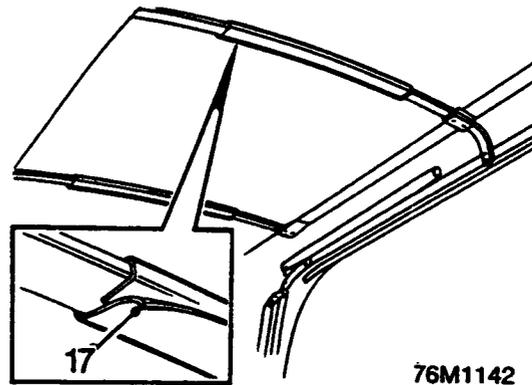

17. Release outer covering from adhesive on forward and central hood spars.
18. Remove outer covering from hood frame complete with rear retainer.

**Refit**

1. Fold new outer covering in half along its length and chalk a centre line on underside of pocket which locates over header rail.
2. Measure and chalk centre line on underside of header rail.
3. Raise hood frame and position hood outer covering assembly.
4. Position rear retainer to rear shelf and tighten bolts to 10 Nm.
5. Attach a suitable length of wire to each cantrail tensioning cable and draw cables through outer covering.
6. Remove draw wires from cables and engage cable ends to tensioning springs.
7. Partially lower hood frame.

Note: Assistance may be necessary to hold frame in partially lowered position.

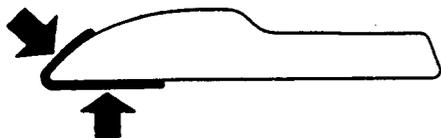

76M1143

8. Apply adhesive to underside and forward edge of header rail as shown.
9. Apply adhesive to mating surfaces of outer covering.
10. Carefully bond outer covering to header rail, starting at centre, ensuring that header rail is engaged fully into pocket and beading along forward edge of cover is straight.

Note: Use a Neoprene based adhesive, such as Dunlop 758, and allow to cure for between 5 and 10 minutes before making the bond.

11. Trim off excess material on underside of header rail using a sharp knife.
12. Position rear hood spar to outer covering.
13. Raise hood and secure catches.
14. Align hood spars to outer covering.
15. Centralise outer covering on hood frame.
16. Apply adhesive to each hood spar and mating areas of outer covering. Carefully bond outer covering to hood spars.

Note: Use a Neoprene based adhesive, such as Dunlop 758, and allow to cure for between 5 and 10 minutes before making the bond.

Note: Assistance may be necessary to hold hood spars in position as adhesive is applied and bond is made. Use card to protect outer covering during application of adhesive.

17. Position finisher to rear hood spar and drill the holes for the pop rivets through finisher into spar.

CAUTION: DO NOT drill through both walls of rear spar.

18. Secure finisher to rear spar with pop rivets.
19. Apply adhesive to 'D' post brackets and mating areas of outer covering.

Note: Use a Neoprene based adhesive, such as Dunlop 758, and allow to cure for between 5 and 10 minutes before making the bond.

20. Fit and tighten nuts securing outer covering to 'D' post brackets.
21. Apply uniform tension to outer covering and make a temporary bond in three small areas along length of each 'D' post bracket.
22. Check hood rear quarters for creases and adjust cover to 'D' post fit as necessary before making final bond.
23. Align seal retainers to 'D' post brackets and pop rivet in place.
24. Fit hood side seals.
25. Fit rear quarter trim panels, see Rear quarter trim panel.

HEATING AND VENTILATION

CONTENTS

Repairs	Page
Fresh air vents	2
Heater valve control cable	2
Heater valve	3
Heater unit	3
Heater matrix	4
Heater motor and fan (Plastic case heater)	4
Heater motor and fan (Metal case heater)	5
Heater control panel (Metal case heater)	6

HEATING AND VENTILATION

FRESH AIR VENTS

Service Repair No. 80.10.35

Remove

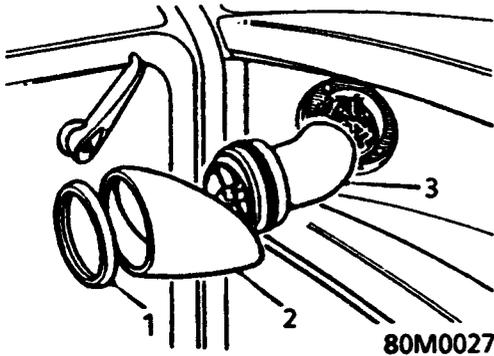

1. Unscrew fresh air vent locking ring.
2. Remove binnacle from the air vent.
3. Turn the air vent anti-clockwise and remove.

Refit

1. Position air vent and turn clockwise to lock in position.
2. Fit binnacle to air vent and secure with locking ring.

HEATER VALVE CONTROL CABLE

Remove

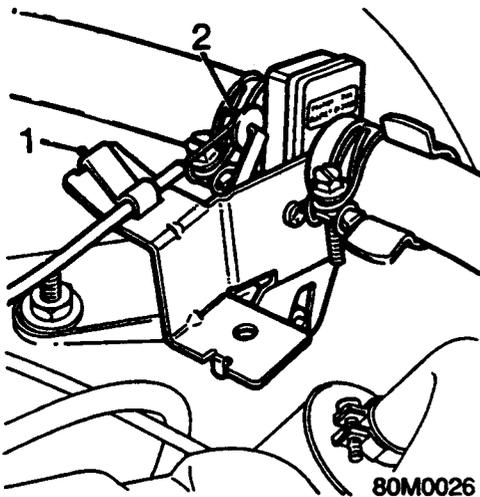

1. Release clip securing outer cable to heater valve abutment bracket.
2. Disconnect the inner cable from the heater valve control lever.

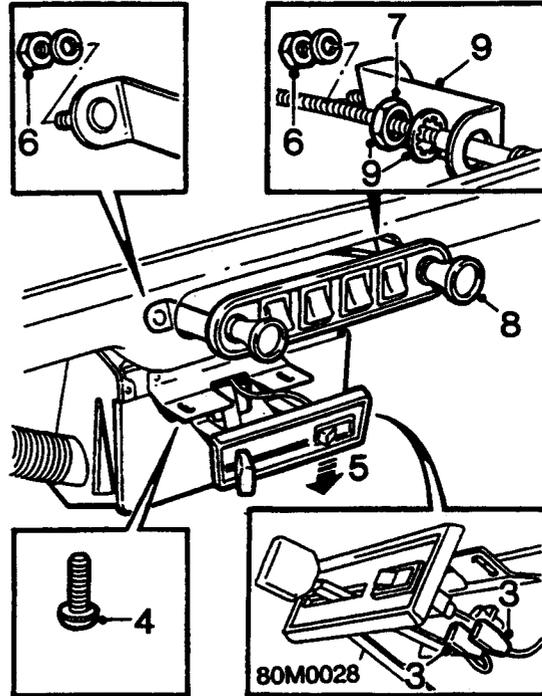

3. Disconnect Lucars from heater motor switch.
4. Remove 2 screws securing front of heater unit to lower fascia rail.
5. Lower heater unit.
6. Remove 2 nuts securing switch panel to lower fascia rail. Pull switch panel from fascia rail.
7. Unscrew nut securing outer cable to switch panel.
8. Withdraw the cable assembly through the bulkhead grommet and switch panel.
9. Collect cable bracket, lock washer and nut.

Refit

1. Feed new cable through switch panel and bulkhead grommet, ensure the cable bracket, lock washer and nut are on the cable.
2. Position cable bracket and tighten lock nut securing cable to switch panel.
3. Push switch panel back into aperture in lower fascia rail and secure with nuts.
4. Raise front of heater and secure to lower fascia rail with screws.
5. Connect Lucars to heater motor switch.
6. Connect inner cable to heater valve control lever.
7. Secure heater control outer cable to abutment bracket with clip.
8. Check that heater valve control lever operates through its full range of travel, adjust position of outer cable if necessary.

HEATER VALVE

Service Repair No. 80.10.16

Remove

1. Partially drain the cooling system, see **MAINTENANCE**.

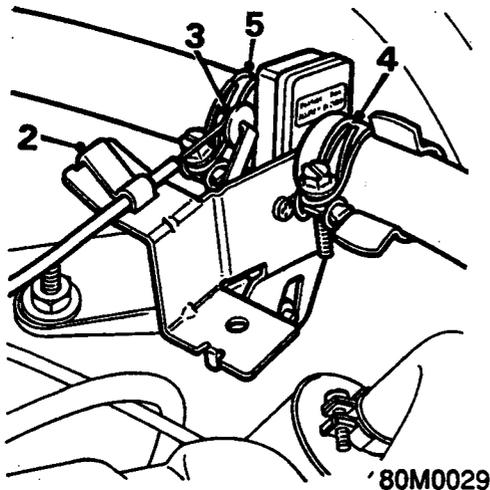

2. Release clip securing outer cable to heater valve abutment bracket.
3. Disconnect the inner cable from the heater valve control lever.
4. Slacken clip securing coolant hose to heater valve and disconnect hose.
5. Slacken clip securing coolant hose to heater valve and disconnect hose.
6. Remove heater valve

Refit

1. Connect coolant hoses to heater valve and tighten clips.
2. Connect inner cable to heater valve control lever.
3. Secure heater control outer cable to abutment bracket with clip.
4. Top - up cooling system, see **MAINTENANCE**.
5. Check that heater valve control lever operates through its full range of travel, adjust position of outer cable if necessary.

HEATER UNIT

Service Repair No. 80.20.01

Remove**WARNING: Support on safety stands.**

1. Drain cooling system, see **MAINTENANCE**.
2. Remove front carpets.

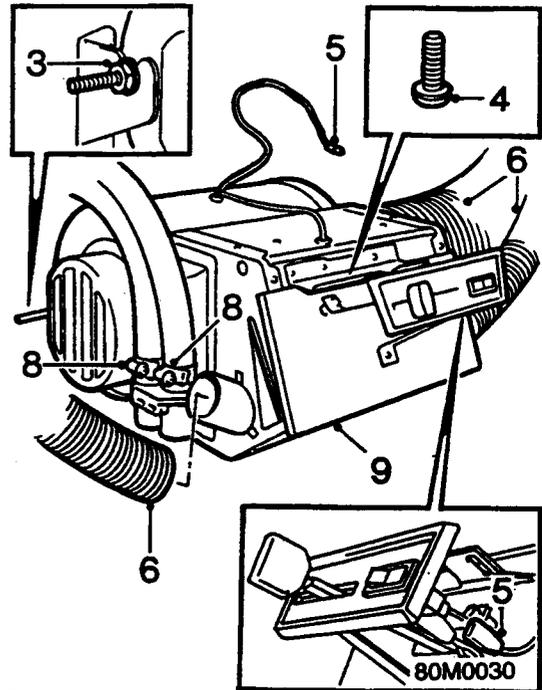

3. Slacken securing nut at rear of heater (if fitted).
4. Remove 2 screws securing front of heater unit to lower fascia rail.
5. Lower heater unit, disconnect Lucars from switch and heater fan connector from harness.
6. Disconnect air intake and demister tubes from heater unit.
7. Position suitable container under heater unit to catch any coolant spillage.
8. Slacken clips and disconnect coolant hoses from heater.
9. Release heater unit from rear mounting brackets and remove from vehicle.

Refit

1. Position heater unit on rear mounting brackets in vehicle.
2. Connect coolant hoses to heater and secure with clips.
3. Connect air intake and demister tubes to heater.
4. Connect heater fan to harness and Lucars to switch.
5. Raise front of heater and secure to lower fascia rail with screws.
6. Tighten nut at rear of heater (if fitted).
7. Fit front carpets.

HEATING AND VENTILATION

8. Refill cooling system, see **MAINTENANCE**.

HEATER MATRIX

Service Repair No. 80.20.29

Remove

1. Remove heater unit from vehicle, see **Heater unit**.

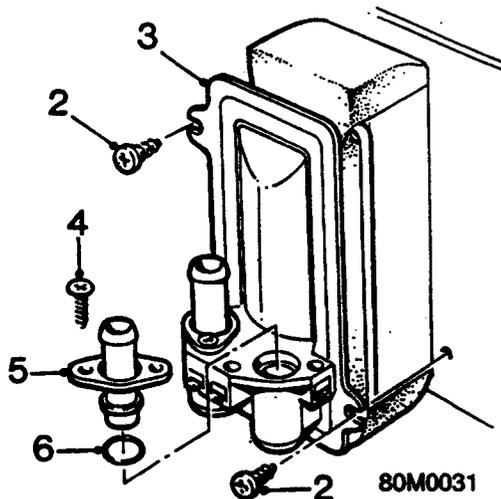

2. Remove 2 screws securing heater matrix end - plate to heater.
3. Withdraw heater matrix from heater.
4. Remove 4 screws securing heater pipe clamp plates to matrix.
5. Remove clamp plates and heater pipes.
6. Remove and discard 'O' rings from heater pipes.

Refit

1. Fit new 'O' rings to heater pipes.
2. Fit heater pipes and clamp plates, secure with screws.
3. Insert heater matrix into heater unit, fit screws securing end plate to heater.
4. Fit heater unit, see **Heater unit**.

HEATER MOTOR AND FAN (PLASTIC CASE HEATER)

Service Repair No. 88.20.15

Remove

1. Remove heater unit from vehicle, see **Heater unit**.

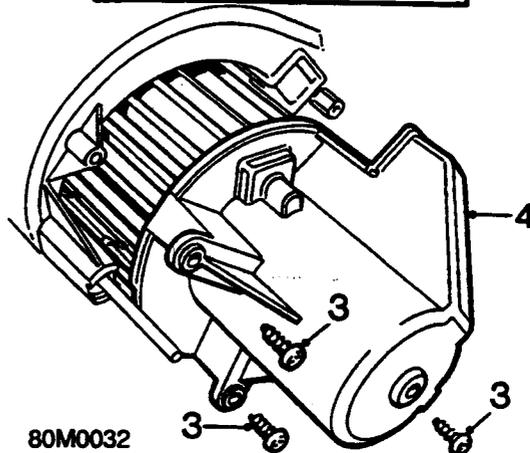
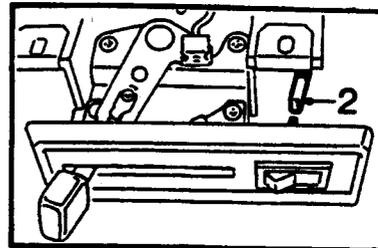

2. Disconnect Lucar from heater motor switch.
3. Remove 3 screws securing heater motor and fan to heater.
4. Withdraw heater motor and fan from heater casing.

Note: The heater motor and fan can only be replaced as a complete unit.

Refit

1. Position heater motor and fan to heater casing, secure with screws.
2. Connect Lucar to heater motor switch.
3. Fit heater unit, see **Heater unit**.

HEATER MOTOR AND FAN (METAL CASE HEATER)

Service Repair No. 88.20.15

Remove

1. Remove heater unit from vehicle, see Heater unit.

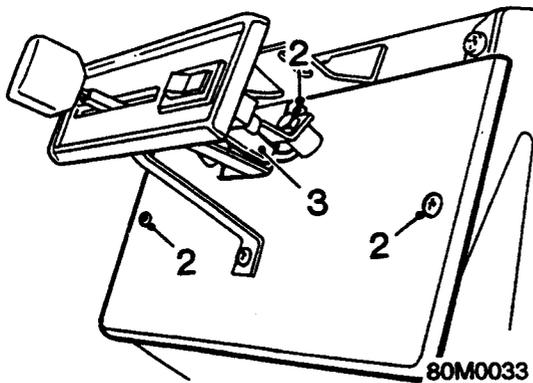

2. Remove 3 screws securing mounting plate to heater.
3. Disconnect Lucar from heater motor switch.

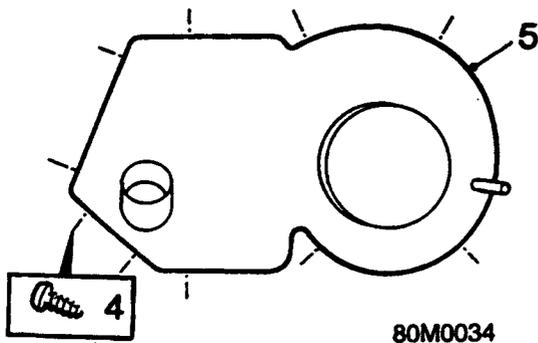

4. Remove 10 screws securing RH side casing to heater unit.
5. Remove RH side casing.

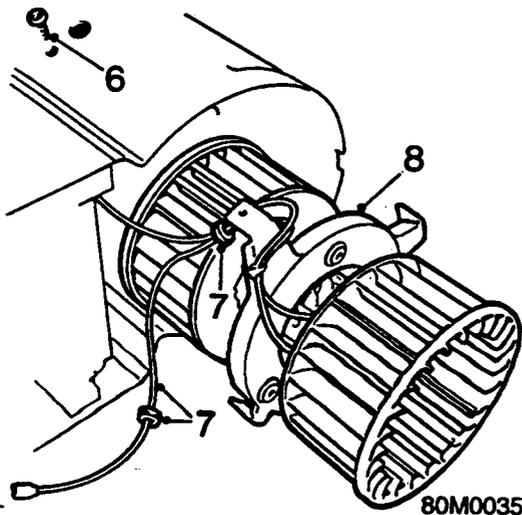

6. Remove 3 screws securing the heater motor to the main heater casing.
7. Release heater motor wires and grommets from casing.

8. Withdraw heater motor and fan assembly from casing.

Note: The heater motor and fan assembly must be replaced as a complete assembly.

Refit

1. Position heater motor and fan in casing, fit and tighten securing screws.
2. Route heater motor wires and grommets through casing.
3. Fit RH side casing and secure with screws.

Note: One screw is shorter than the others and is fitted in the front lower hole of the side casing.

4. Connect Lucar to heater motor switch.
5. Position mounting plate to heater and secure with screws.
6. Fit heater unit, see Heater unit.

HEATING AND VENTILATION

HEATER CONTROL PANEL (METAL CASE HEATERS)

Remove

1. Remove heater unit from vehicle, see **Heater unit**.

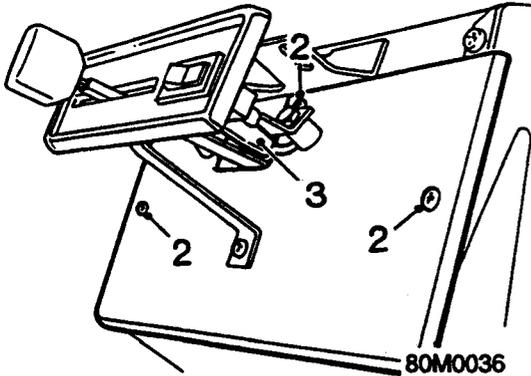

2. Remove 3 screws securing mounting plate to heater.
3. Disconnect Lucar from heater motor switch.

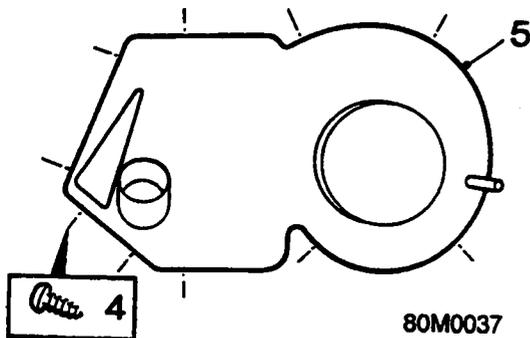

4. Remove 10 screws securing RH side casing to heater.
5. Remove RH side casing.

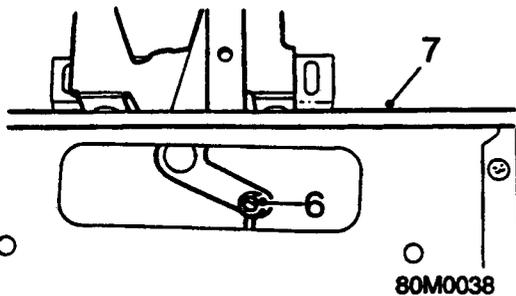

6. Slacken screw securing air distribution flap to control arm.
7. Remove mounting plate and control panel assembly.

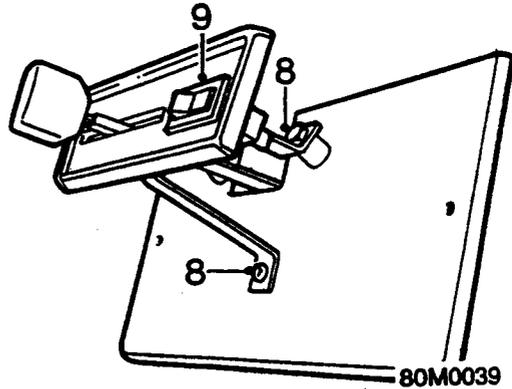

8. Remove 2 bolts and screw securing heater control panel to mounting plate.
9. Release and remove heater motor switch.

Refit

1. Fit heater motor switch to control panel.
2. Align control panel to mounting plate, fit and tighten securing bolts and screw.
3. Connect air distribution flap to control arm and tighten screw.
4. Fit RH side casing to heater and secure with screws.

Note: One screw is shorter than the others and is fitted in front lower hole of the side casing.

5. Connect Lucar to heater motor switch.
6. Position mounting plate and control panel assembly to heater and secure with screws.
7. Fit heater unit to vehicle, see **Heater unit**.

WIPERS & WASHERS

CONTENTS

Description and Operation	Page
Windscreen wiper components	3
Windscreen washer components	5
Windscreen wiper and wash operation	6

Repairs	Page
Wiper arm and blade	1
Wiper motor	1
Wiper motor drive and wheel boxes	2
Wiper motor overhaul	3
Windscreen washer pump and reservoir	5
Washer jets and tubing	5



WIPERS & WASHERS

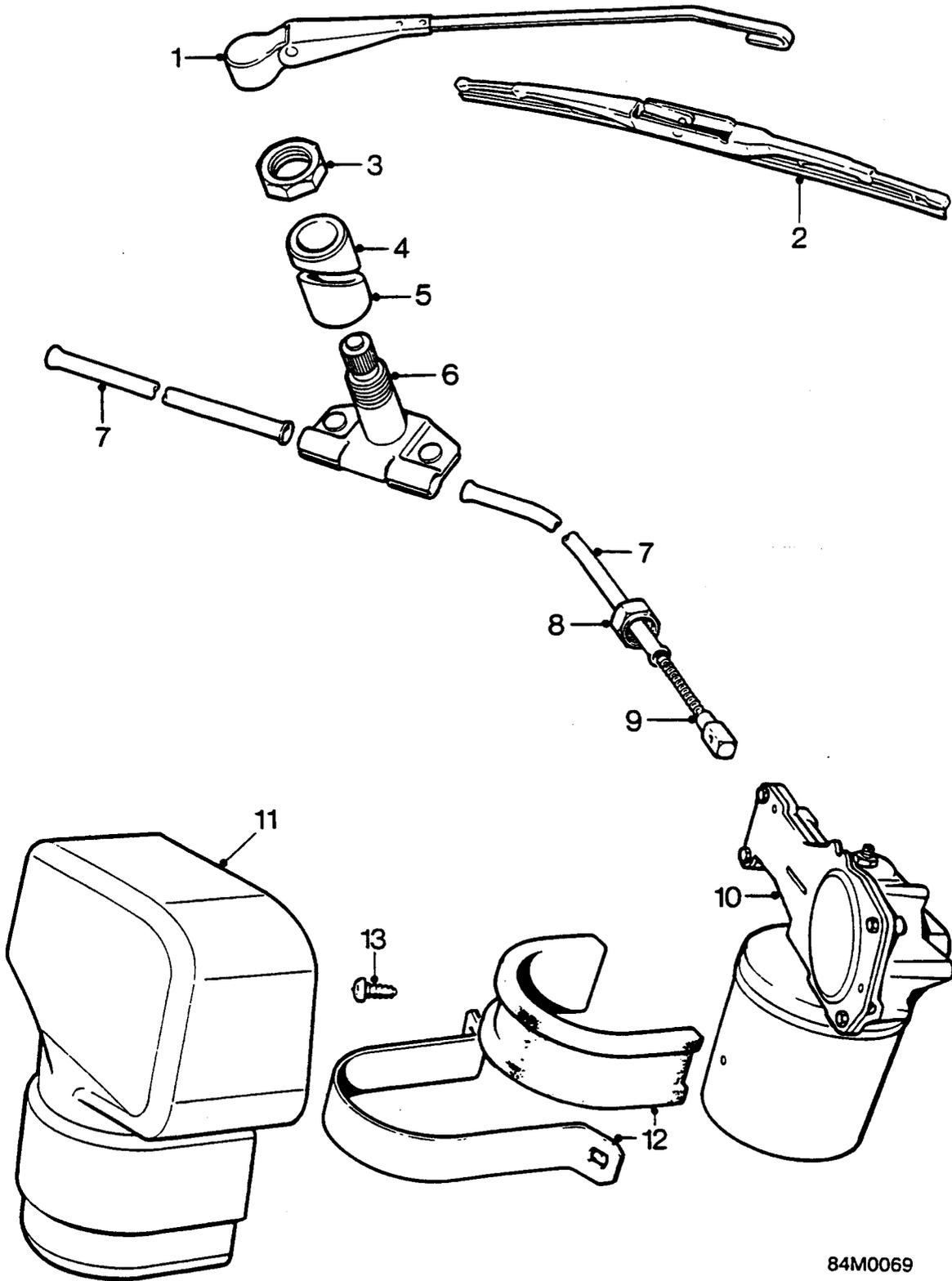

84M0069

**WINDSCREEN WIPER COMPONENTS**

1. Windscreen wiper arm
2. Windscreen wiper blade
3. Wiper spindle nut
4. Top spacer rubber
5. Lower spacer rubber
6. Wheelbox assembly
7. Outer casing
8. Outer casing retaining nut
9. Cable rack
10. Wiper motor
11. Wiper motor cover
12. Wiper motor retaining strap
13. Screw

WIPERS & WASHERS

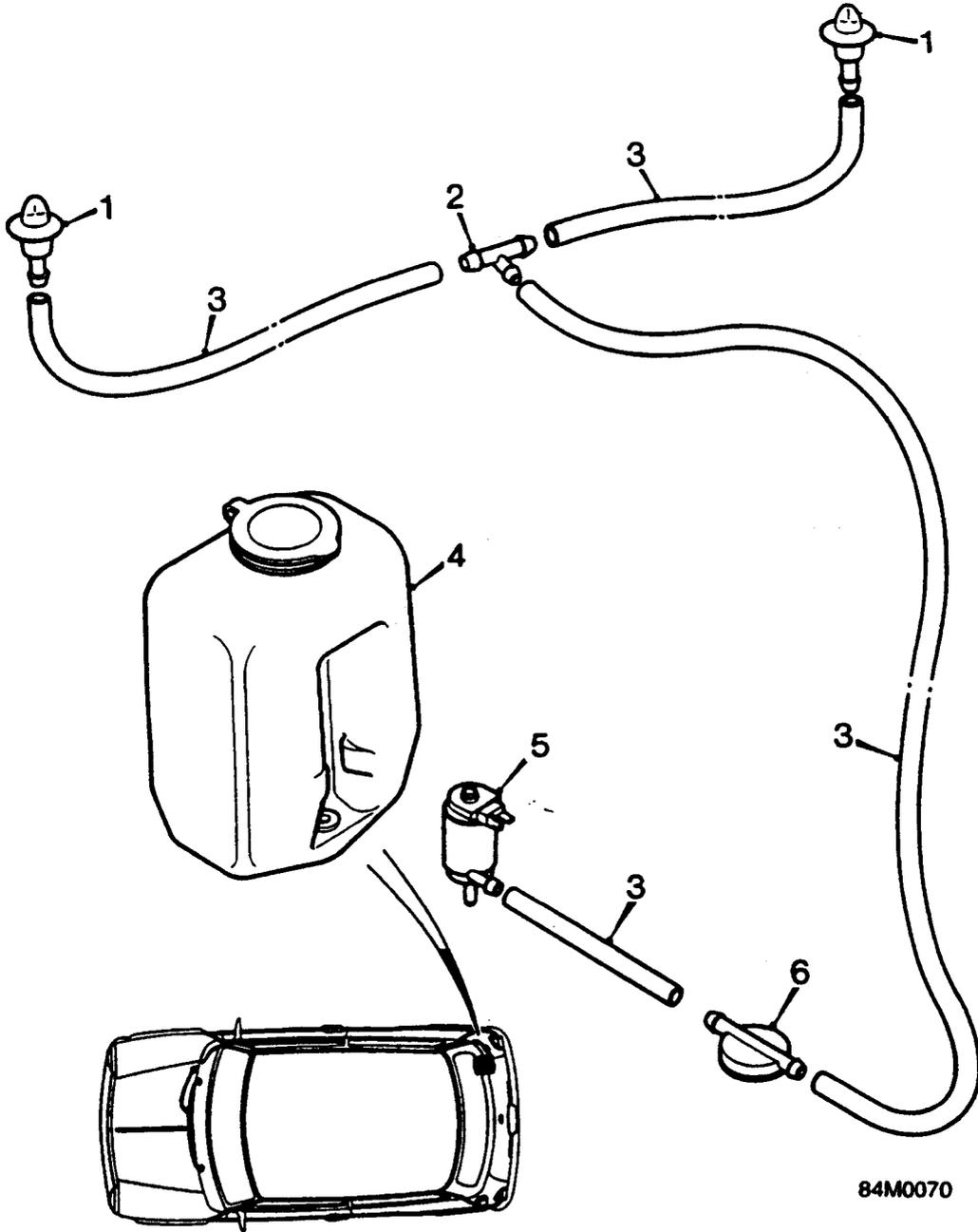



WINDSCREEN WASHER COMPONENTS

1. Washer jet
2. Tee connection
3. Windscreen washer tube
4. Reservoir
5. Windscreen washer pump
6. One - way valve

WIPERS & WASHERS

WINDSCREEN WIPER AND WASH OPERATION

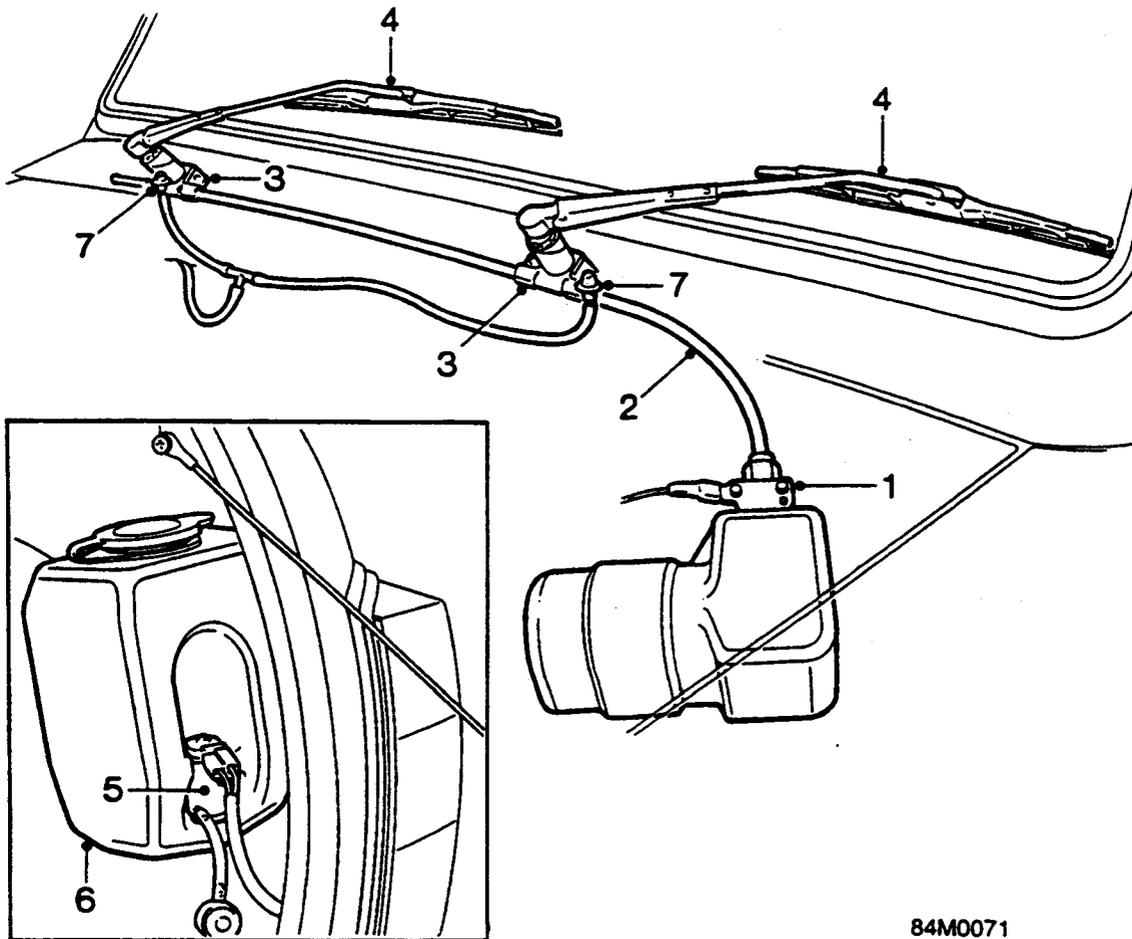

84M0071

Operation of the windscreen wipers and washers is controlled by the wash/ wipe switch mounted on the RH side of the steering column. The wiper switch may be moved from the OFF position to selected positions; Normal speed, Fast speed and Single wipe. Single wipe being obtained by flicking the switch downwards. The windscreen washer will operate when the switch at the outer end of the lever is depressed.

When the wiper switch is moved to any ON position a two speed wiper motor (1) provides a drive through a cable rack (2) to the wiper wheelboxes (3). The wheelboxes convert the lateral motion of the cable rack into the sweeping motion of the wiper blades and arms (4).

When the windscreen washer switch is depressed, washer fluid is drawn by an electric pump (5) from the reservoir (6) located in the boot, and is sprayed against the windscreen by the jets (7).



WIPER ARM AND BLADE

Service Repair No. 84.15.02

Remove

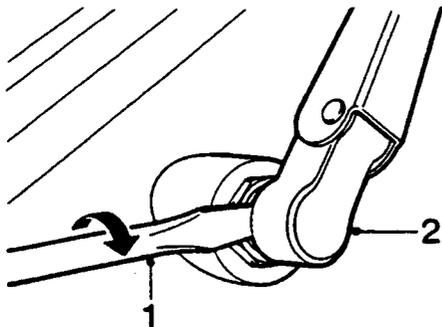

84M0072

1. Carefully pry up the wiper arm from the wheelbox splines as shown, using a flat bladed screwdriver or similar tool.
2. Remove wiper arm with blade from wheelbox spindle.

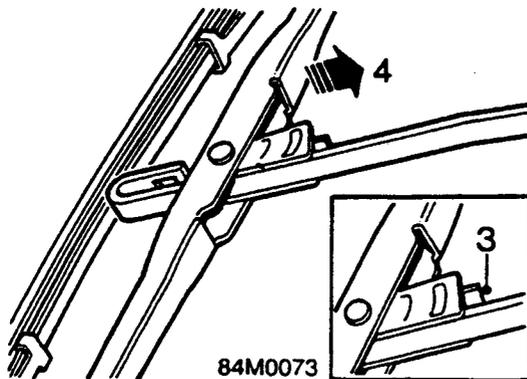

84M0073

3. Press and release clip.
4. Remove blade.

Refit

1. Fit wiper blade to arm.
2. Align wiper arm to screen and push onto wheelbox splines.

WIPER MOTOR

Service Repair No. 84.15.09

Remove

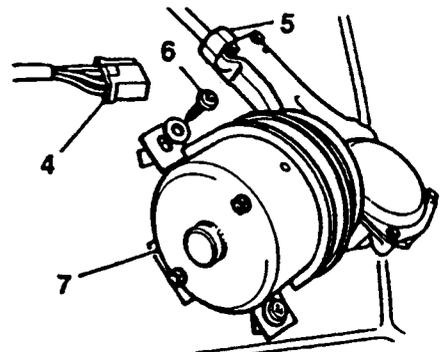

84M0074

1. Disconnect battery earth lead. Disconnect the battery.
2. Remove the wiper arms.
3. Remove rubber cover from wiper motor.
4. Disconnect the wiring connector from the motor.
5. Unscrew the retaining nut from the motor ferrule.
6. Remove 2 screws securing wiper motor to body.
7. Withdraw the motor complete with the cable rack.

Refit

1. Smear the cable rack with Ragosine Listate Grease.
2. Push the cable rack into the outer casing, ensuring the rack engages with the wheelbox teeth, and position the motor retaining strap and mounting pad.
3. Fit screws securing wiper motor to body.
4. Tighten the motor ferrule retaining nut.
5. Connect harness connector to wiper motor and fit cover.
6. Align wiper arms to screen and push onto wheelbox splines.
7. Connect battery earth lead.

WIPERS & WASHERS

WIPER MOTOR DRIVE AND WHEEL BOXES

Service Repair No. 84.15.10

Remove

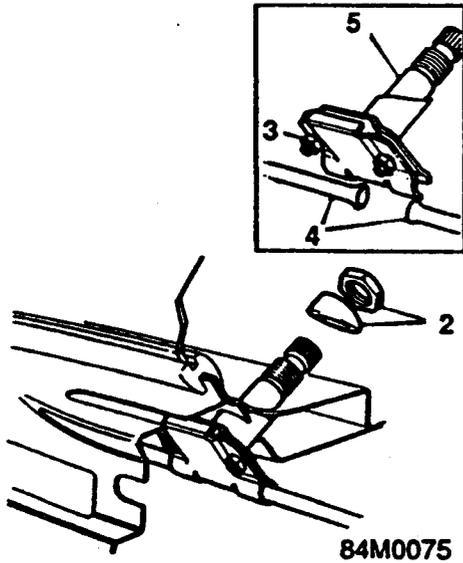

1. Remove wiper motor and drive, see **Wiper motor**
2. Unscrew retaining nut and remove top rubber spacer from each wheelbox.
3. Slacken the nuts clamping the wheelbox plates.
4. Release outer casings from wheelboxes.
5. Remove wheelboxes.

Refit

1. Check condition of the wheel teeth and the cable rack. Renew a wheelbox or rack cable as necessary.
2. Grease wheel and spindle and fit wheel boxes to top panel
3. Position outer casing to wheel box and secure with nut.
4. Ensure the motor to wheelbox outer cover is not kinked or flattened. Bend radius on the outer casing must not be less than 230 mm (9 in).
5. Test cable rack in outer casing, if excessive friction is suspected: Remove cable rack from motor. Use a spring balance to check the pull required to withdraw cable rack from casing does not exceed 2.7 kgf (6lbf).
6. Fit top rubber spacer and secure with nut.
7. Fit wiper motor and drive, see **Wiper motor**.



WIPER MOTOR OVERHAUL

Service Repair No. 84.15.18

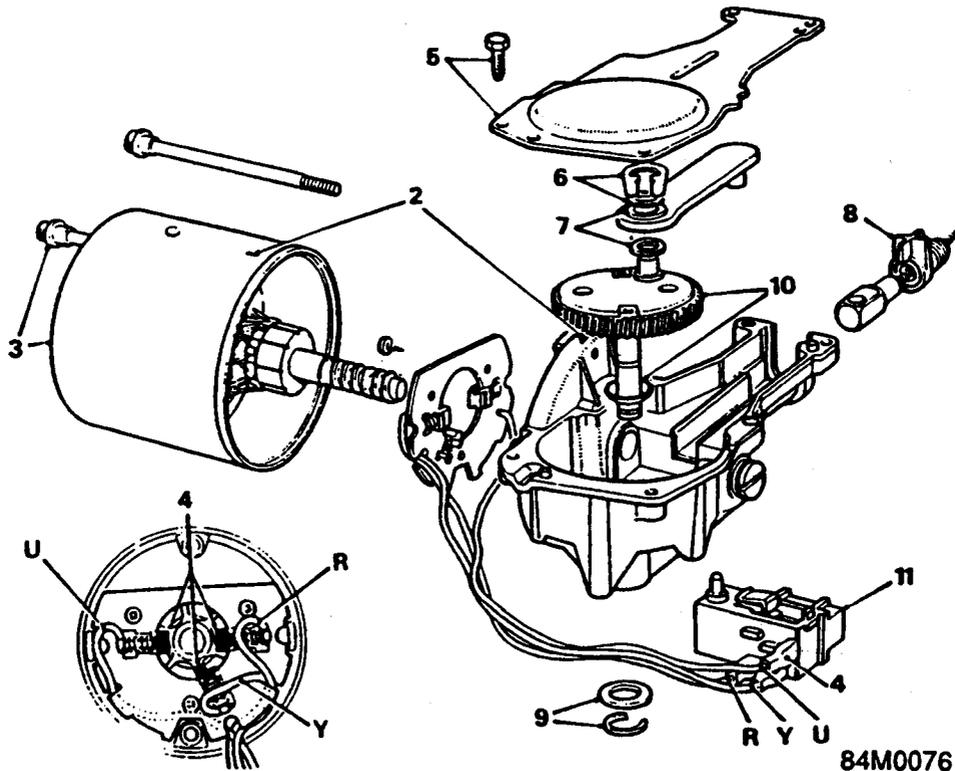

Dismantle

Note: To change brushes only, follow procedures 1 to 4.

1. Remove the wiper motor and drive, see **Wiper motor**
2. Note alignment marks on the yoke and gearbox for assembly.
3. Remove the two through-bolts and remove the yoke and armature assembly.

CAUTION: The yoke must be kept clear of metal particles which will be attracted to the pole-piece.

4. Note the colour and position of the wiring. Withdraw the brushes from the insulating plate and disconnect the leads from the switch assembly.

Wire colours:

R = Red. U = Blue. Y = Yellow.

5. Remove the four gearbox cover retaining screws and remove the cover.
6. Remove the circlip and flat washer from the connecting rod to the crank pin.
7. Withdraw the connecting rod and the flat washer fitted under it.
8. Withdraw the cable rack with cross-head and outer casing ferrule.
9. Remove the circlip and washer securing the shaft and gear.

10. Clean up any burrs from the gear shaft and withdraw the gear, taking care not to loose the dished washer fitted under it.
11. Park switch assembly: Pull outwards and down to release the retaining clips.

Inspection

12. Examine the brushes if the main brushes (diametrically opposite) are worn to 4.8 mm (0.19 in), or if the narrow section of the third brush is worn to the full width of the brush, the brushes must be renewed. Renew the brush gear assembly if the springs are not satisfactory.

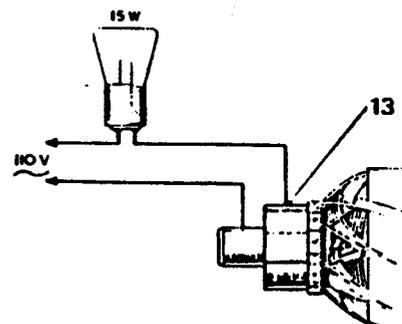

13. Test the armature for insulation and open or short circuits. Use a test lamp (110 volts, 15 watts). Renew if the armature is faulty.

WIPERS & WASHERS

14. Examine the gear wheel for damage or excessive wear, renew if necessary.

screw in the adjuster until resistance is felt, and back - off the screw a quarter turn.

Assembly

1. Reverse the procedure in 1 to 11.
2. Use Ragosine Listate Grease to lubricate the gear wheel teeth, armature shaft worm gear, connecting rod and pin, cross - head slide, cable rack and wheelbox gear wheels.
3. Use a high quality engine oil to lubricate the bearing bushes, armature shaft bearing journals (sparingly), gear wheel shaft and crankpin, felt washer in the yoke bearing (thoroughly soak) and the wheelbox spindles.
4. Tighten the yoke through - bolts to 1.0 Nm.

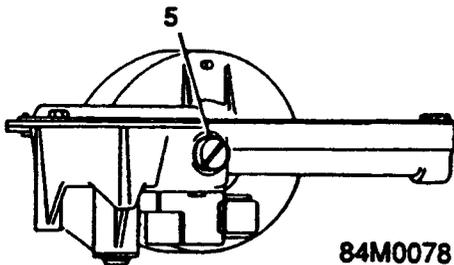

5. If a replacement armature is being fitted, slacken the thrust screw to provide end - float for fitting the yoke.
6. Fit the dished washer beneath the gear wheel with its concave towards the gear wheel.

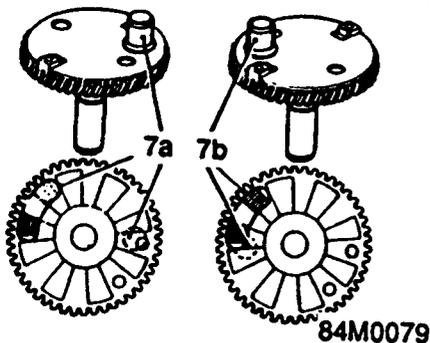

7. When fitting the gear wheel, ensure that the relationship of the crankpin and ramp is correct for the parking condition required:
(a) = R.H.D vehicles: cable rack extended with the crankpin adjacent to the cam.
(b) = L.H.D vehicles: cable rack retracted with the crankpin opposite to the cam.
8. Ensure that the larger of the two washers if fitted to the crankpin is beneath the connecting rod.
9. Armature end - float: Hold the yoke vertical with the adjuster screw uppermost. Carefully



WINDSCREEN WASHER PUMP AND RESERVOIR

Service Repair No. 84.30.02

Remove

1. Open the boot lid.

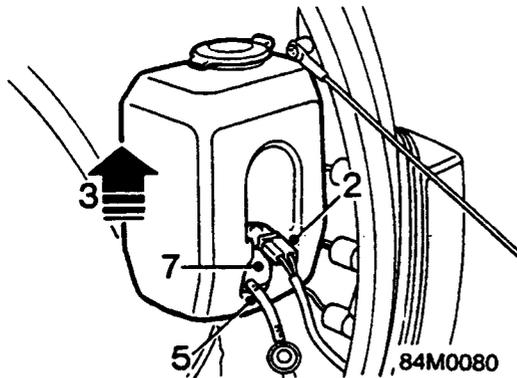

2. Disconnect the multiplug from the washer pump.
3. Release the reservoir from its retaining bracket by carefully pulling upwards.
4. Withdraw and drain the reservoir.
5. Carefully prise the tube off the pump.
6. Withdraw the reservoir.
7. Release the pump from the reservoir.
8. Remove the pump seals.

Refit

1. Fit new pump seal to reservoir.
2. Lubricate seal and fit pump to reservoir.
3. Connect washer tube.

Note: If the washer tube proves difficult to connect to the pump, immerse the end of the tube in hot water for a few seconds, then connect the tube to the pump.

4. Position the reservoir in the retaining bracket.
5. Refit pump wiring connector.
6. Fill the reservoir with an approved screen wash additive and check the operation of the washers.

WASHER JETS AND TUBING

Service Repair No. 84.10.09

Remove

1. Raise the bonnet.

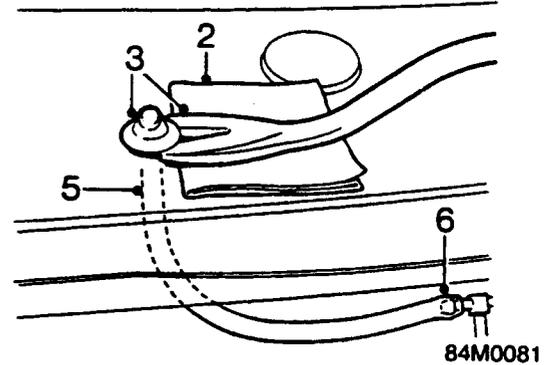

2. Place a soft cloth nest to washer jet to protect the paintwork.
3. Insert a trim stud remover tool under the lip of the jet.
4. Carefully lever washer jet from body.
5. Disconnect the washer tube from the jet.
6. Disconnect the tubes from the Tee connection.

Note: The delivery tube from the boot mounted reservoir, is routed under the carpets on the RH side of the vehicle

Refit

1. Connect washer tubes to Tee connection and washer jets.
2. Position washer jet to body and push to secure in body.
3. Check and adjust the firing position of the washer jet onto the screen.

ELECTRICAL

CONTENTS

General Information	Page
REPAIR PROCEDURES FOR WIRING HARNESSSES	2
Introduction	2
Repair techniques	3
Typical wiring harness faults	4
Typical earth faults	9
WIRING CONNECTOR PROBING TECHNIQUES	12
Introduction	12
Connector types and connector probing	13
Typical wiring connector faults	15

Repairs	Page
Service precautions	1
Alternator - A127	1
Starter motor - Type M79	2
Starter motor solenoid	2
Headlamp assembly	3
Tail lamp assembly	3
Number plate lamp housing	4
Front indicator lamp	5
Auxiliary driving lamps	5
Driving lamp	6
Fuse box	6
Ignition/starter switch	7
Column switches	8
Panel switch	8
Stop lamp switch	9
Dim - dip resistor	9
Radio cassette player	10
Front speaker	11
Heel board speaker	11
Rear speaker	12
ECU - Anti - theft	12
Bonnet switch - Anti - theft	13
Boot switch - Anti - theft	13
Volumetric sensor	13

Wiring Diagrams	Page
Introduction	2
Fuses	2
Fuse box details	3
Line fuse details	3
Power distribution circuit - Carburettor models	5
Power distribution circuit - SPi models	7
Exterior lamps and horn circuit	9
Driving lamps circuit	10
Fog lamp circuit	10
Reverse lamps, brake lamps and heated rear window circuit	11
Direction indicator and hazard warning circuit	13
Instrument circuit	15



ELECTRICAL

CONTENTS

Interior lamp circuit - (Saloon)	16
Interior lamp circuit (Cabriolet)	16
Heater circuit	17
Automatic gearbox selector	17
Engine management circuit	18
Anti - theft alarm circuit	21
Wash wipe circuit	22
Auxiliary cooling fan circuit	23
Brake test circuit	23
Radio/cassette player	24
Sun roof circuit	25
Headlamp levelling circuit (Germany)	26

Wire Harness and Earth Locations

	Page
Harness runs	1
Main harness - Under bonnet - SPi models	1
Main harness - Passenger compartment	2
Engine compartment harness	3
Body harness	4
Driving lamp harness	5
Radio harness - Cabriolet models	6



REPAIR PROCEDURES FOR WIRING HARNESSES

Introduction

1. Verify the complaint

Turn on all the components in the problem circuit to verify and check the accuracy of the customer complaint.

Note the symptoms, do not begin disassembly or testing until you have narrowed down the problem area.

2. Analyse the wiring diagram

Refer to the relevant wiring diagram of the problem circuit. Familiarise yourself with the circuit and determine how the circuit is supposed to work by tracing the current path from the power source, through the circuit components to earth.

The problem circuit may be fed from or feed a number of other circuits, and these will be identified on the wiring diagram. Try operating these circuits. If the other circuits work OK then the fault lies in the wiring of the problem circuit only. If several of the other circuits do not work then the fault lies in the wiring shared by those circuits, i.e. a fuse or earth path is a likely cause.

Based on the symptoms and your understanding of the circuits operation, identify possible areas where the cause of the problem may be found.

3. Isolate the problem by testing the circuit

Make circuit tests to check the diagnosis you made in step 2. Keep in mind that a logical, simple procedure is the key to efficient fault finding. Test for the most likely cause first.

Try to make tests at points that are easily accessible.

4. Fix the problem

Once the specific problem is identified make the repair. Be sure to use the proper tools and safe procedures.

5. Intermittent failure

The term "Intermittent Failure" is used when a system may have had a failure but checks out OK through all your tests. You may need to road test the vehicle to reproduce the failure, or if the problem was a loose connection you may have unknowingly solved it while doing tests.

6. Open or short circuits

An "Open" is a break in a wire or at a connection. A "Short" is an accidental connection of a wire to earth, or a positive feed.

In simple electronics; this means something won't work at all.

In complex electronics; like Electronic Control Units (ECU's) this means something works but not the way it is supposed to.

7. Confirm and verify repairs

Always confirm that your diagnosis and repair is complete by verifying the complaint and symptom. Then road test the vehicle when repairs are completed.



Repair techniques

Preparing the wire

Disconnect the battery.

Begin by cutting as little off the length of wire as possible. You may need the extra length of wire later if you decide to change the location of your repair. You may have to adjust the repair location to make certain that your repair is at least 40mm away from other repairs, connectors or splices.

Note: Strip 7mm of insulation from the wire.

Check the stripped ends of the wire for nicks and cuts in the strands. If the wire is damaged, repeat the procedure on a new section of wire.

The two stripped wire ends should be equal in length.

When replacing a section of wire, use a wire that is the same gauge as the original or larger. If you are not sure of the wire gauge use a pair of wire strippers as a gauge by starting with the largest opening and working downwards until you get a completely clean strip of insulation.

Making the repair

Crimp the two wire ends into a "Duraseal" connector. Apply hot air to the joint, using a hot air blower, and slowly rotate the joint to ensure the shrinking of the insulation is uniform and connector ends are sealed to the wires.

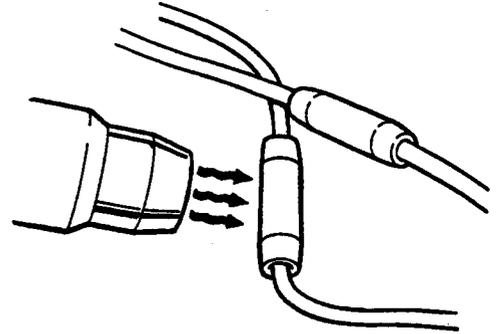

86M 2534

CAUTION: Extreme care must be taken when using a hot air blower. Deflect heat away from interior trim, carpets, etc. Do not touch the nozzle of the hot air blower or heatshrink connector until sufficiently cooled.

After allowing time for the repair to cool refit the wire into the harness. Re-tape the wiring harness ensuring the repair does not interfere with the fit of the harness or any components nearby.

Completing the repair

Reconnect the battery, check repaired circuit for correct operation, and all related circuits. Always confirm that your diagnosis and repair is complete by verifying the complaint and symptom.

Typical wiring harness faults

Pinched

Symptom

Wiring damaged or shorted to ground causing: Fuse(s) to blow, circuit(s) not to operate or not to operate correctly.

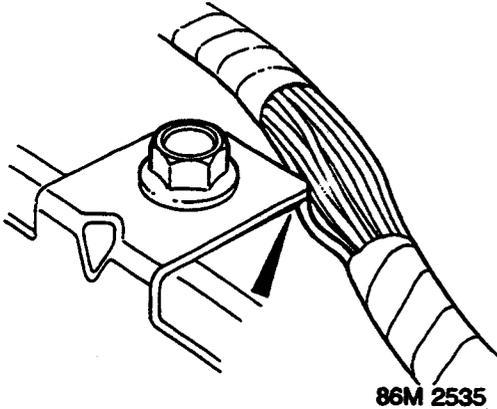

86M 2535

Wire trapped.

Cause

The wire(s) is pinched or trapped by another component, e.g. a bracket, trim or finisher.

Action

Locate damaged section of wiring/harness, carefully cut back the tape or insulation from the harness with a suitable tool. If the harness has a black plastic conduit simply pull out the desired wire(s), see **Repair Techniques**.

Chafed

Symptom

Wiring damaged or shorted to ground causing: Fuse(s) to blow, circuit(s) not to operate or not to operate correctly. Circuit operation possibly affected by dampness/moisture. Possible intermittent fuse failure.

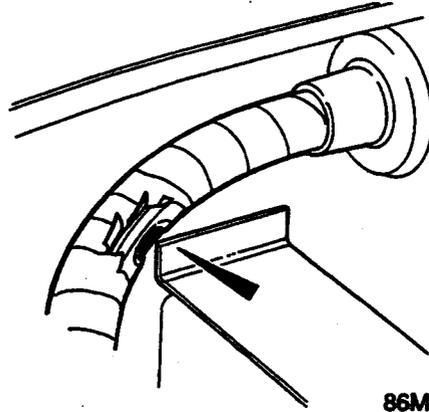

86M 2536

Damaged insulation exposes wire strands

Cause

The wire(s) is chafed due to wear or abrasion against another component, e.g. body panels, brackets, suspension components, etc.

Action

Locate damaged section of wiring/harness, carefully cut back the tape or insulation from the harness with a suitable tool. If the harness has a black plastic conduit simply pull out the desired wire(s), see **Repair Techniques**.

If only minor damage to the wire(s) insulation is present, (no damage to the bare wires) it may be OK to repair by taping up the damaged section.



Cut or Broken

Symptom

Wire is completely cut through causing: Open circuit, circuit(s) not to operate or not to operate correctly. Possible intermittent fuse failure.

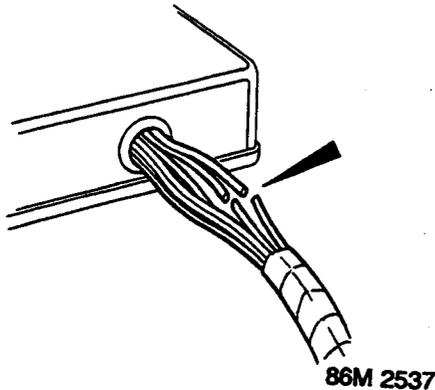

Cause

The wire(s) is under stress as a result of the harness being routed incorrectly, snapped by another component, e.g. a sharp edge on a bracket, or body panel.

Action

Locate damaged section of wiring/harness, carefully cut back the tape or insulation from the harness with a suitable tool. If the harness has a black plastic conduit simply pull out the desired wire(s), see **Repair Techniques**.

Overheated (exterior heat)

Symptom

Wiring damaged or shorted to ground causing: Fuse(s) to blow, circuit(s) not to operate or not to operate correctly.
Wiring damaged or open circuit causing: Circuit(s) not operating or not operating correctly.

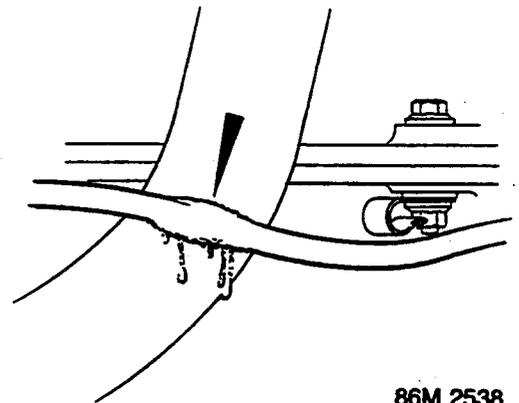

Wire insulation melted

Cause

The insulation has melted due to contact with a component which is hot, e.g. the exhaust manifold. Possibly due to the harness being routed or retained incorrectly.

Action

Locate damaged section of wiring/harness, carefully cut back the tape or insulation from the harness with a suitable tool. If the harness has a black plastic conduit simply pull out the desired wire(s), see **Repair Techniques**.

Overheated (short circuit)

Symptom

Wiring damaged or shorted to ground causing:
Fuse(s) to blow, circuit(s) not to operate or not to operate correctly.

Wiring damaged or open circuit causing: Circuit(s) not operating or not operating correctly.

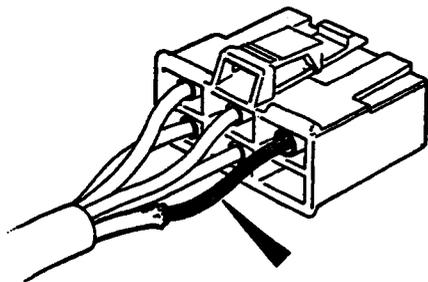

86M 2539

Wire insulation burned

Cause

The insulation has burned due to the wire being shorted. Possibly due to the nature of the fault or previous attempts at repair. Burned insulation is normally due to more current passing through a wire than it is rated for.

Action

Locate damaged section of wiring/harness, carefully cut back the tape or insulation from the harness with a suitable tool. If the harness has a black plastic conduit simply pull out the desired wire(s), see **Repair Techniques**.

Incorrect routing

Symptom

Intermittent circuit operation.

Dynamic faults i.e. faults do not occur until the vehicle is driven round corners or over rough/bumpy roads.

Wiring damaged or shorted to ground causing:
Fuse(s) to blow, circuit(s) not to operate or not to operate correctly.

Wiring damaged or open circuit causing: Circuit(s) not to operate or not to operate correctly.

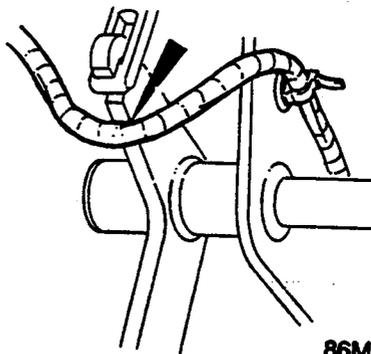

86M 2540

Wire harness incorrectly routed

Cause

The wiring does not follow the correct routing, wiring is too tight or too slack, interfering with another component.

Action

Re-route the wiring harness, and secure in clips and retainers as necessary. Ensure no damage exists to the harness, its insulation and connectors.



Insufficient wire length

Symptom

Intermittent circuit operation.

Dynamic faults, i.e. faults do not occur until the vehicle is driven round corners or over rough/bumpy roads.

Wiring damaged or shorted to ground causing:
Fuse(s) to blow, circuit(s) not to operate or not to operate correctly.

Wiring damaged or open circuit causing: Circuit(s) not to operate or not to operate correctly.

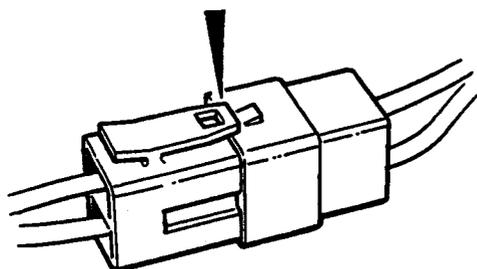

86M 2541

Connector latch not pushed home

Cause

The wiring is correctly routed but not long enough.
Connectors cannot be mated securely.

Action

Re-route the wiring harness, and secure in clips and retainers as necessary. Ensure no damage exists to the harness, its insulation and connectors.

Wire crossed in connector

Symptom

Incorrect circuit operation.

Possibly more than one circuit affected.

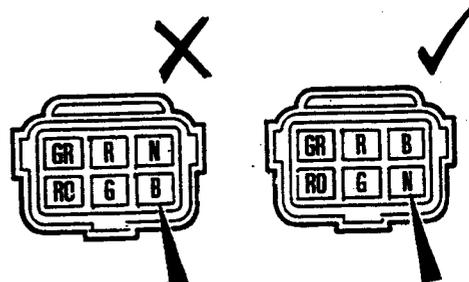

86M 2542

Black(B) and Brown(N) wires crossed.

Cause

The arrangement of the wires in the connector on the vehicle does not match that shown in the connector view section.

Action

Remove wire terminals from connector block and arrange correctly, ensuring proper retention of terminals in connector block.
Check correct operation of circuit(s).

ELECTRICAL

Wire missing from connector

Symptom

Incorrect circuit operation.

Possibly more than one circuit affected.

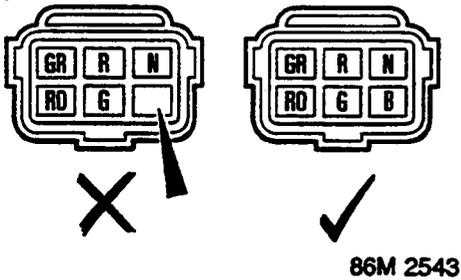

Black(B) wire missing

Cause

One of the wires which should be in the connector is missing.

The arrangement of the wires in the connector on the vehicle does not match that shown in the connector view section.

Action

Locate missing wire (peel back harness tape/insulation if necessary).

When replacing a wire or terminal be careful not to make the wire too short, if necessary add a length of wire and join using a "Duraseal" heatshrink connector.

Refit wire terminal into connector block correctly, ensuring proper retention of terminals in connector block.

Check correct operation of circuit(s).



Typical earth faults

Paint on body contact point

Symptom

Incorrect circuit operation, possibly more than one circuit affected.

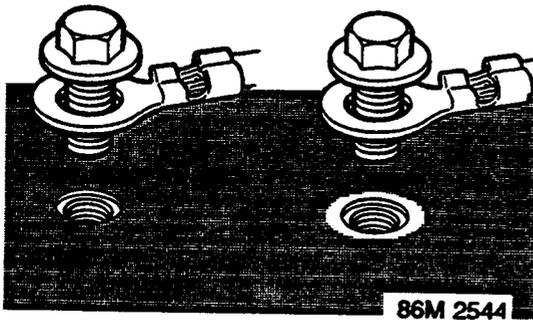

Poor earth contact

Cause

Paint has not been properly removed and there is no good contact to the bare metal.

Action

Unbolt the earth wire(s) and thoroughly clean area in a 10 mm radius of the earth point. Treat the prepared area and earth terminals with a recommended wiring connector grease. Refit earth wires and tighten fixing bolt securely.

Note: *Incorrect grease type will make the connection worse, under no circumstances use silicon oil or grease as this is a perfect insulator.*

Corroded

Symptom

Incorrect/intermittent circuit operation, possibly more than one circuit affected.

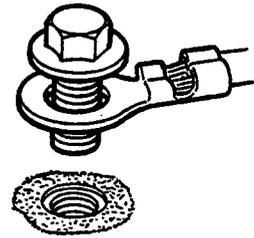

86M 2545

Poor earth contact

Cause

The earth point is rusted and the corrosion is preventing a good contact with the bare metal.

Action

Unbolt the earth wire(s) and thoroughly clean area in a 10 mm radius of the earth point. Treat the prepared area and earth terminals with a recommended wiring connector grease. Refit earth wires and tighten fixing bolt securely.

Note: *Incorrect grease type will make the connection worse, under no circumstances use silicon oil or grease as this is a perfect insulator.*

ELECTRICAL

Loose

Symptom

Incorrect/intermittent circuit operation, possibly more than one circuit affected.

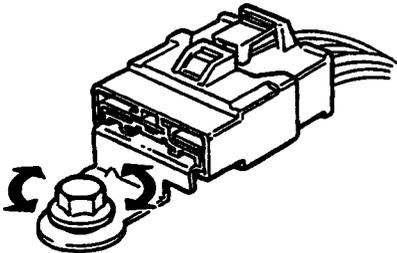

86M 2546

Cause

The bolt fixing the earth eyelet or header to the body is not properly tightened.

Action

Unbolt the earth wire(s) and thoroughly clean area in a 10 mm radius of the earth point. Treat the prepared area and earth terminals with a recommended wiring connector grease. Refit earth wires and tighten fixing bolt securely.

Note: Incorrect grease type will make the connection worse, under no circumstances use silicon oil or grease as this is a perfect insulator.

Disconnected

Symptom

Incorrect circuit operation, possibly more than one circuit affected.

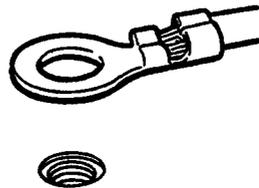

86M 2547

Cause

The earth eyelet or header is not connected to the body at all.

Action

Thoroughly clean area in a 10 mm radius of the earth point. Treat the prepared area and earth terminals with a recommended wiring connector grease. Fit earth wire(s) and tighten fixing bolt securely.

Note: Incorrect grease type will make the connection worse, under no circumstances use silicon oil or grease as this is a perfect insulator.

**Crimped over the insulation****Symptom**

Incorrect circuit operation, possibly more than one circuit affected.

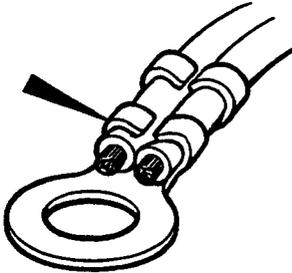

86M 2548

Wire insulation under the crimp

Cause

The earth terminal/header does not make proper contact with the wire because the crimp is over the insulation.

Action

Replace wiring terminal.
Be careful not to make the wire too short, if necessary add a length of wire and join using a "Duraseal" heatshrink connector, see **Repair Techniques**.

WIRING CONNECTOR PROBING TECHNIQUES

Introduction

Over recent years many different styles, shapes and colours of wiring connectors have been utilised on Rover vehicles as ever increasing reliability and integrity is sought. Probing each of the different types of connector with test equipment requires differing techniques. The following steps must always be remembered when tackling electrical fault diagnosis and repair.

1. Verify the complaint

Turn on all the components in the problem circuit to verify and check the accuracy of the customer complaint.

Note the symptoms. Do not begin disassembly or testing until you have narrowed down the problem area.

2. Analyse the wiring diagram

Refer to the relevant wiring diagram of the problem circuit. Familiarise yourself with the circuit and determine how the circuit is supposed to work by tracing the current path from the power source, through the circuit components to earth.

The problem circuit may be fed from or feed a number of other circuits, and these will be identified on the wiring diagram. Try operating these circuits. If the other circuits work OK then the fault lies in the wiring of the problem circuit only. If several of the other circuits do not work then the fault lies in the wiring shared by those circuits, i.e. a fuse or earth path is a likely cause.

Based on the symptoms and your understanding of the circuits operation, identify possible areas where the cause of the problem may be found.

3. Isolate the problem by testing the circuit

Make circuit tests to check the diagnosis you made in step 2. Keep in mind that a logical, simple procedure is the key to efficient fault finding. Test for the most likely cause first.

Try to make tests at points that are easily accessible.

4. Fix the problem

Once the specific problem is identified make the repair. Be sure to use the proper tools and safe procedures.

5. Intermittent failure

The term 'Intermittent Failure' is used when a system may have had a failure but checks out OK through all your tests. You may need to road test the vehicle to reproduce the failure, or if the problem was a loose connection you may have unknowingly solved it while doing tests.

6. Open or short circuits

An 'Open' is a break in a wire or at a connection. A 'Short' is an accidental connection of a wire to earth, or a positive feed.

In simple electronics; this means something won't work at all.

In complex electronics; like Electronic Control Units (ECU's) this means something works but not the way it is supposed to.

7. Confirm and verify repairs

Always confirm that your diagnosis and repair is complete by verifying the complaint and symptom. Then road test the vehicle when repairs are completed.



Connector types and connector probing

Despite the many different appearances and colours connectors can be grouped into three categories.

1. Connectors with covers

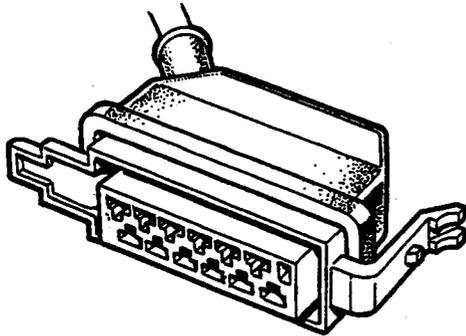

86M 2549

Examples of this connector are on the engine management ECU and the fuel injector connectors.

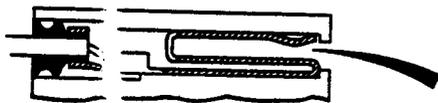

86M 2550

Insert test probe here

For testing at these style of connectors bring the tester probe into contact with the terminal from the connector side of wire harness connectors. For female connectors, insert the special probe carefully.

Note: Do not attempt to remove rubber seal and probe into the rear of the connector as damage to the seal will occur.

2. Sealed connectors (with individually sealed wires)

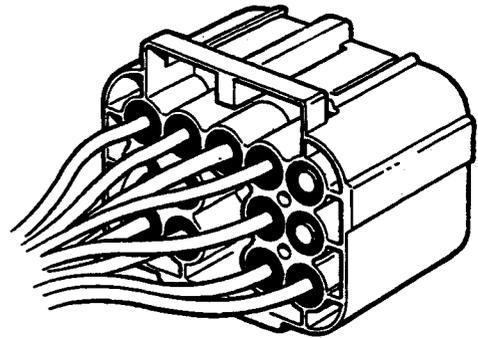

86M 2551

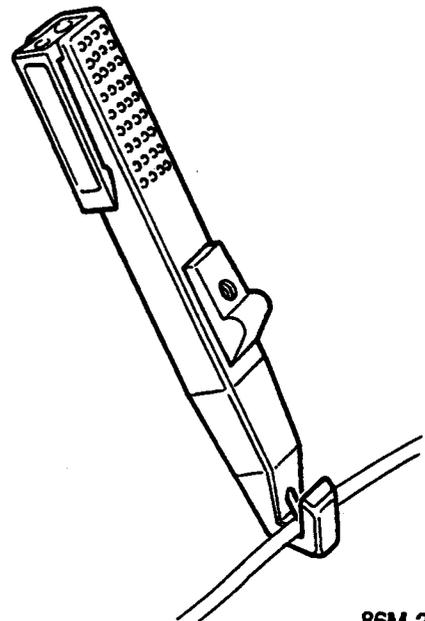

86M 2552

For testing at these style of connectors use the hook and pin probe. Carefully separate out the wire for testing, bring the probe over the wire to be tested. Release probe carefully and gradually puncture the wire insulation to avoid necessary damage the insulation or wire strands.

Check that the wire colour matches the pin/cavity number. If it does not, rectify this first as probing will not find the fault

Note: Do not attempt to carry out this test with any other hook and pin probe than the Rover special tool included as part of TestBook.

3. Non - sealed connectors

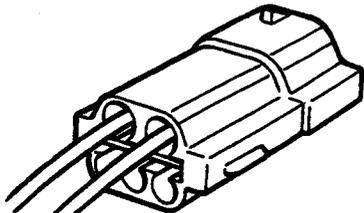

86M 2553

Examples of this connector are the style used on the rear of instrument packs, etc.

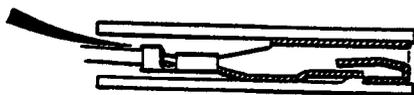

86M 2554

Insert test probe here

For testing at these type of connectors bring the tester probe into contact with the terminal from the wiring side (back) of the connector.
Do not force it as damage to the pin will result.



Typical wiring connector faults

Crimped over insulation

Symptom

No continuity between the terminal and wire.

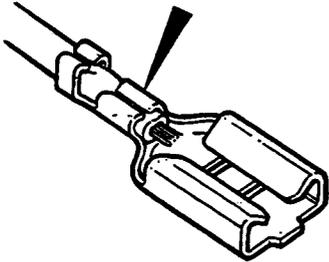

86M 2555

Wire insulation under crimp

Cause

The terminal does not make proper contact with the wire because the crimp is over the insulation

Action

Replace wiring terminal

Be careful not to make the wire too short, if necessary add a length of wire and join using a "Duraseal" heatshrink connector, see **Repair Techniques**.

Backed out of connector

Symptom

No continuity between terminal and component, intermittent or no contact.

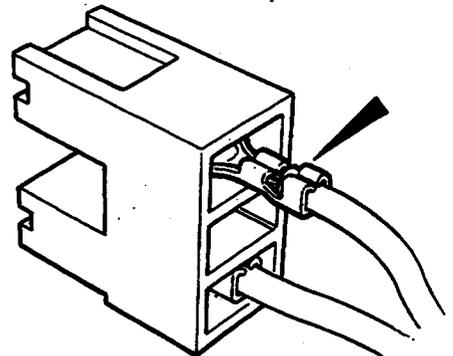

86M 2556

Terminal not properly latched in housing

Cause

Terminal keeper (barb) not properly latched in the housing

Action

Try pushing the pin in, then pull back lightly to see if the pin comes out. Carefully bend keeper (barb) on terminal to allow secure retention, or replace terminal if damaged.

ELECTRICAL

Bent or damaged terminal

Symptom

No continuity between terminal and component, intermittent or no contact

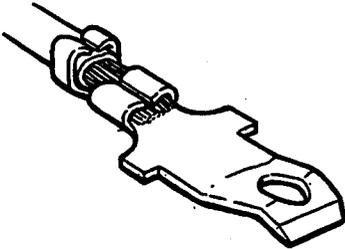

86M 2557

Cause

The terminal is damaged so that it will either not fit into the housing or cannot be mated to the matching part.

Action

Repair or replace terminal and ensure correct retention in terminal housing. When replacing a terminal be careful not to make the wire too short, if necessary add a length of wire and join using a "Duraseal" heatshrink connector, see **Repair Techniques**.

Corroded or wet terminal

Symptom

No continuity between terminal and component, intermittent or no contact.

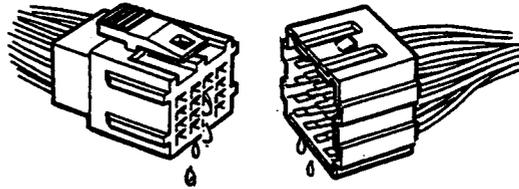

86M 2558

Water ingress in terminal

Cause

Connector waterproofing missing, connector subjected to water ingress.

Action

Replace corroded terminal(s), treat with a recommended wiring connector grease. reposition connector if possible to prevent any further water ingress.

Note: *Incorrect grease type will make the connection worse, under no circumstances use silicon oil or grease as this is a perfect insulator.*

**Loose****Symptom**

No continuity between terminal and component, intermittent or no contact

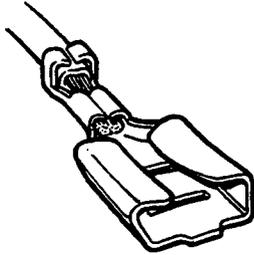

86M 2559

Cause

The male and female terminals do not mate properly because the female terminal has opened out.

Action

Repair or replace terminal, ensuring a positive connection is made between the male and female terminal(s).

When replacing a terminal be careful not to make the wire too short, if necessary add a length of wire and join using a "Duraseal" heatshrink connector, see **Repair Techniques**.

Disconnected**Symptom**

No continuity between terminal and component, intermittent or no contact. If applied to an earth wire the system concerned could still operate but at reduced output.

Most wire strands broken

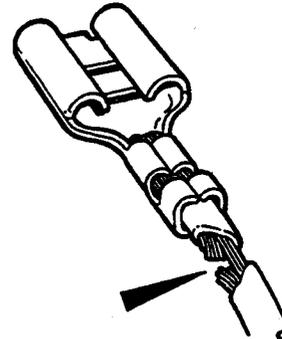

86M 2560

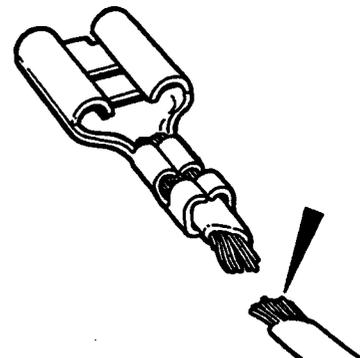

86M 2561

Wire broken off

Cause

Most or all of the wire strands are broken off at the terminal. Possibly due to excessive harness flex or incorrect routing.

Action

Cut back section of damaged wire and replace terminal.

When replacing a terminal be careful not to make the wire too short, if necessary add a length of wire and join using a "Duraseal" heatshrink connector, see **Repair Techniques**.



SERVICE PRECAUTIONS

Service Repair No. 86.01.01

Polarity

Ensure that the correct battery polarity is maintained at all times: reversed battery or charger connections will damage the alternator rectifiers.

Battery connections

The battery must never be disconnected while the engine is running.

Testing semi-conductor devices

Never use an Ohm-meter of the type incorporating a hand-driven generator for checking the rectifiers or the transistors.

ALTERNATOR - A127

Service Repair No. 86.10.02

Remove

1. Disconnect battery earth lead.
2. Release 3 turnbuckles securing splash shield to rocker cover and lower fixing.
3. Remove splash shield.

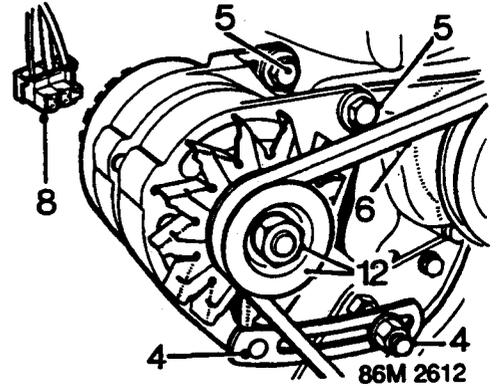

4. Slacken alternator adjusting link nut and alternator bolt.
5. Slacken 2 alternator pivot bolts.
6. Release drive belt from alternator pulley.
7. Remove bolt, alternator to adjustment bracket.
8. Release spring clip and disconnect the multiplug from alternator.
9. Remove 2 alternator pivot bolts.

Do not carry out further dismantling if component is removed for access only

10. Hold alternator centre shaft with an Allen key.
11. Remove pulley locknut.
12. Remove pulley from alternator.

Refit

1. Clean pulley and shaft.
2. Fit pulley to alternator.
3. Fit pulley locknut and tighten to 37 Nm.
4. Position alternator in vehicle.
5. Fit alternator pivot bolts. Do not tighten.
6. Fit drive belt to alternator pulley.
7. Fit bolt, alternator to adjustment bracket. Do not tighten.
8. Tension alternator drive belt, see **MAINTENANCE**.
9. Fit multiplug and secure with clip.
10. Connect battery earth lead.

STARTER MOTOR - TYPE M79

Service Repair No. 86.60.01

Remove

1. Disconnect battery earth lead.

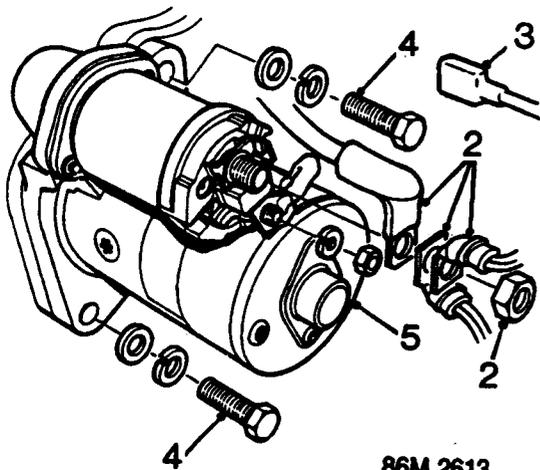

86M 2613

2. Remove nut securing leads to solenoid main terminal.
3. Disconnect Lucar connector from solenoid.
4. Remove 2 bolts securing starter motor to flywheel housing.
5. Remove starter motor.

Refit

1. Position starter motor to flywheel housing, fit and tighten bolts to 37 Nm.
2. Fit leads to solenoid main terminal and secure with nut.
3. Connect Lucar to solenoid.
4. Connect battery earth lead.

STARTER MOTOR SOLENOID

Service Repair No. 86.60.08

Remove

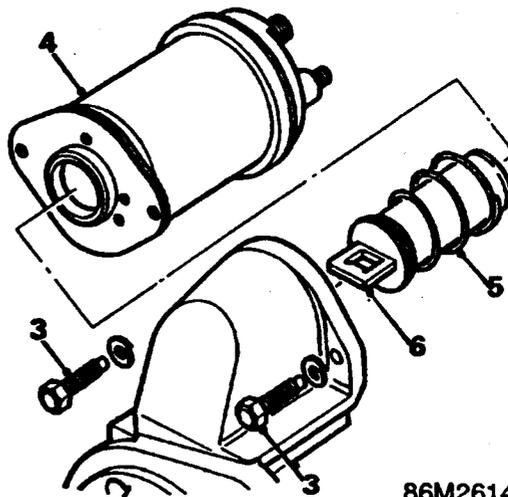

86M2614

1. Remove starter motor, see **Starter motor**.
2. Remove nut and release starter lead from solenoid.
3. Remove 2 bolts securing solenoid to starter motor.
4. Remove solenoid body.
5. Remove solenoid spring.
6. Unhook and remove solenoid plunger.

Refit

1. Fit spring to solenoid plunger.
2. Connect solenoid plunger to starter motor.
3. Fit solenoid body to starter motor, fit and tighten bolts.
4. Connect starter lead to solenoid terminal and secure with nut.
5. Refit starter motor, see **Starter motor**.



HEADLAMP ASSEMBLY

Service Repair No. 86.40.49

Remove

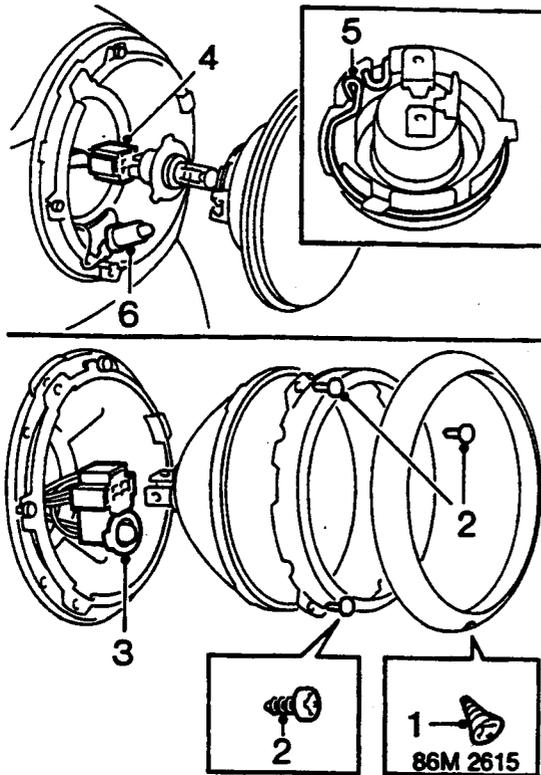

1. Remove screw securing headlamp chrome finisher.
2. Remove 3 screws securing headlamp surround.

Sealed beam unit

3. Disconnect connector from headlamp assembly.

Halogen bulb unit

4. Disconnect connector from headlamp bulb.
5. Release clip and remove bulb from headlamp.
6. Release sidelight from headlamp assembly.

Refit

1. *Halogen bulb unit:* Fit headlamp and sidelight bulbs.
2. Connect headlamp connector.
3. Fit headlamp to body.
4. Fit headlamp surround and secure with screws.
5. Fit chrome finisher and secure with screw.

TAIL LAMP ASSEMBLY

Service Repair No. 86.40.76

Remove

1. *Cabriolet models:* Remove spare wheel cover.
2. Disconnect battery earth lead.

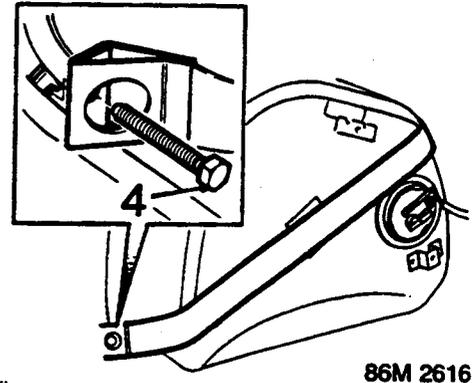

86M 2616

LH tail lamp only

3. Remove bolt securing fuel tank strap to body.
4. Remove fuel tank filler cap.
5. Release fuel tank strap and move fuel tank towards centre of luggage compartment.

Both tail lamps

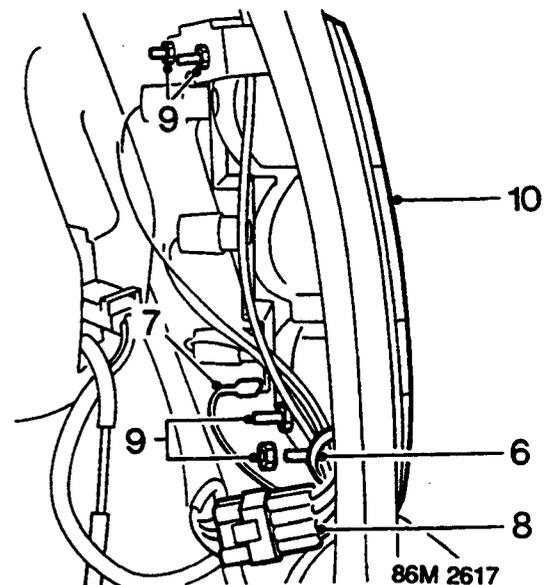

86M 2617

6. Slacken harness cable tie.
7. Disconnect Lucar connector from lamp.
8. Disconnect tail lamp multiplug from harness.
9. Remove 4 nuts securing tail lamp to body.
10. Remove tail lamp and sealing rubber.

Refit

1. Position tail lamp and sealing rubber to body.
2. Fit and tighten 4 securing nuts.
3. Connect tail lamp multiplug and Lucar connector.
4. Secure harness to body with cable tie.

ELECTRICAL

LH tail lamps only.

5. Position fuel tank in luggage compartment, fit fuel tank strap.
6. Fit and tighten fuel tank strap bolt to hold fuel tank firmly in place.
7. Fit fuel filler cap.
8. Connect battery earth lead.
9. *Cabriolet models*: Fit spare wheel cover.

NUMBER PLATE LAMP HOUSING

Service Repair No. 86.40.86

Remove

Cabriolet models

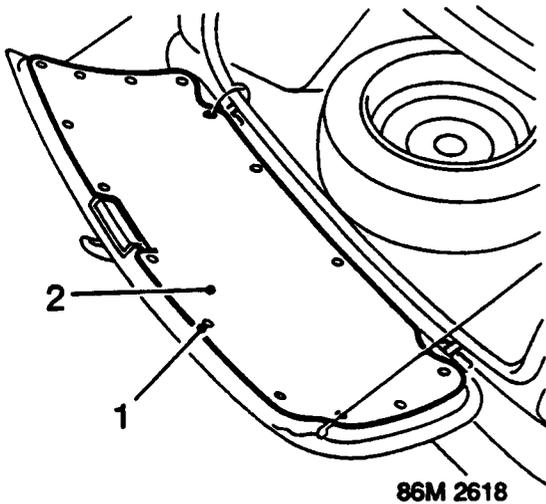

1. Remove 14 trim studs securing luggage compartment lid liner.
2. Remove luggage compartment lid liner.

All models

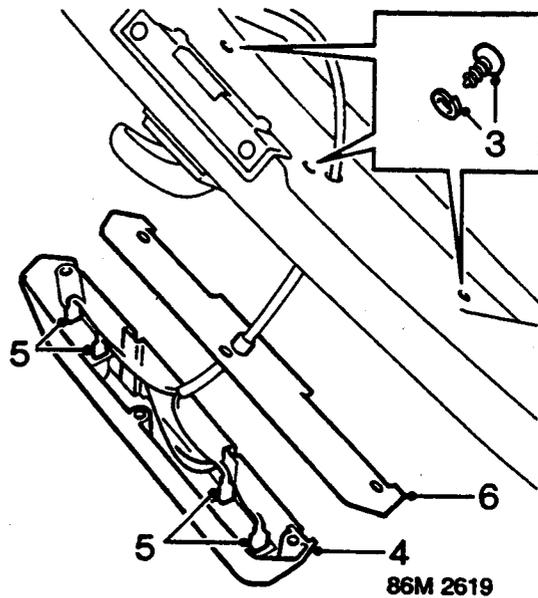

3. Remove 3 screws securing number plate lamp housing to luggage compartment lid.
4. Release lamp housing from lid.
5. Disconnect 4 Lucars and remove lamp housing
6. Remove sealing rubber from lid.

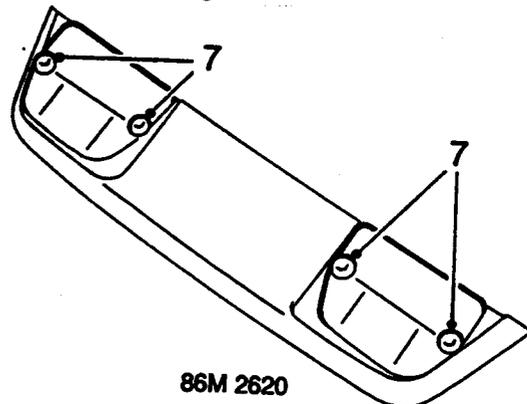

7. Remove 4 screws securing lamps to housing.

Refit

1. Fit lamps to housing and secure with screws.
2. Fit sealing rubber to luggage compartment lid.
3. Connect Lucars to number plate lamps.
4. Position lamp housing to luggage compartment lid and secure with screws.

Cabriolet models only

5. Position luggage compartment lid liner and secure with trim studs.



FRONT INDICATOR LAMP

Service Repair No. 86.40.86

Remove

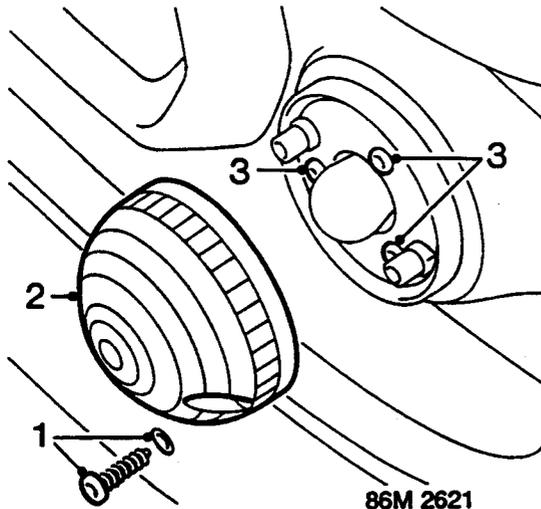

86M 2621

1. Remove 2 screws securing lens to lamp.
2. Remove lens.
3. Remove 3 screws securing lamp to body.

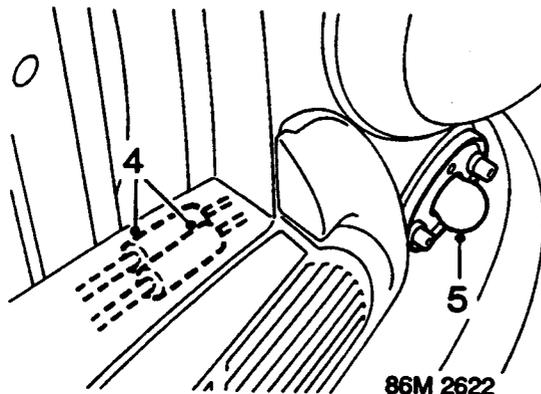

86M 2622

4. Disconnect 2 headlamp harness connectors from main harness located behind bonnet locking platform.
5. Remove lamp assembly from body.

Refit

1. Position lamp assembly to body and route harness through inner wing.
2. Connect indicator lamp harness connectors to main harness.
3. Fit and tighten screws securing lamp to body.
4. Position lens to lamp assembly and secure with screws.

AUXILIARY DRIVING LAMPS

Service Repair No. 86.40.96

Remove

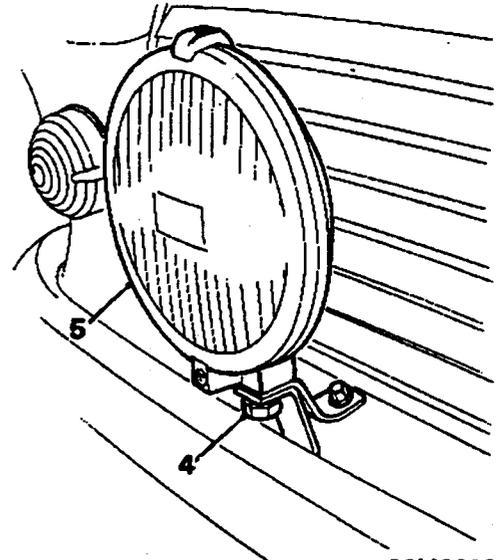

86M2623

1. Remove front grille, see **BODY - Repairs**.
2. Locate and disconnect driving lamp harness multiplug.
3. Release lamp harness from bonnet locking platform.
4. Remove nut securing lamp to bracket.
5. Remove lamp from bracket.

Do not carry out further dismantling if component is removed for access only

6. Remove 2 nuts securing lamp bracket to body.
7. Remove bracket from body.
8. Position bracket to body, fit and tighten nuts to 15 Nm.

Refit

1. Fit lamp to bracket and secure with nut
2. Connect lamp harness multiplug.
3. Secure harness to bonnet locking platform.
4. Fit grille, see **BODY - Repairs**.
5. Check operation of lamps. Adjust beams so that they are 1 degree below horizontal.

ELECTRICAL

DRIVING LAMP

Service Repair No. 86.40.96

Remove

1. Raise front of vehicle.

WARNING: Support on safety stands.

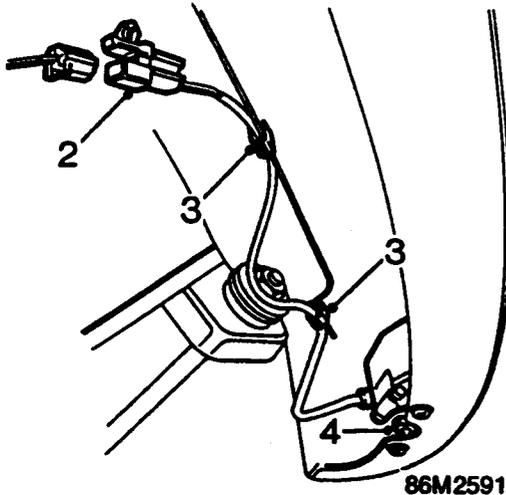

2. Disconnect driving lamp multiplug from main harness.
3. Release harness from 2 clips on body.
4. Slacken nut securing lamp to bracket.
5. Remove nut, collect washer and remove lamp from bumper.

Refit

1. Position lamp to bumper.
2. Fit and tighten retaining washer and nut.
3. Connect driving lamp multiplug.
4. Secure harness to clips on body.
5. Remove stand(s) and lower vehicle.
6. Check operation of lamps. Adjust beams so that they are 1 degree below horizontal.

FUSE BOX

Service Repair No. 86.70.01

Remove

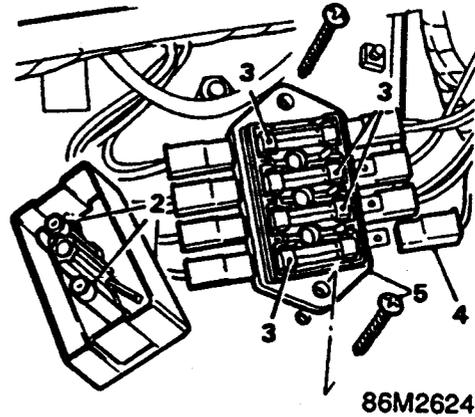

1. Disconnect battery earth lead.
2. Pull off fuse box cover and remove spare fuses from holders in cover.
3. Remove fuses from fuse holders, noting rating and location of fuses.
Fuse 1 - 2 17 or 35A
Fuse 3 - 4 12 or 25A
Fuse 5 - 6 12 or 25A
Fuse 7 - 8 8 or 15A
4. Disconnect the wire connectors from the fuse box terminals
5. Remove the two retaining screws and remove the fuse box from the bulkhead.

**Refit**

1. Position fuse box to bulkhead and secure with screws.

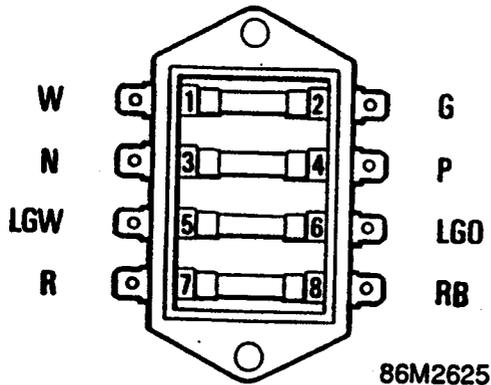

2. Connect wire connectors to fuse box terminals.
3. Insert the correct rating fuse into each fuse holder.
4. Refit spare fuses and fit cover.
5. Connect battery earth lead.

IGNITION/STARTER SWITCH

Service Repair No. 86.65.03

Remove

1. Disconnect battery earth lead.

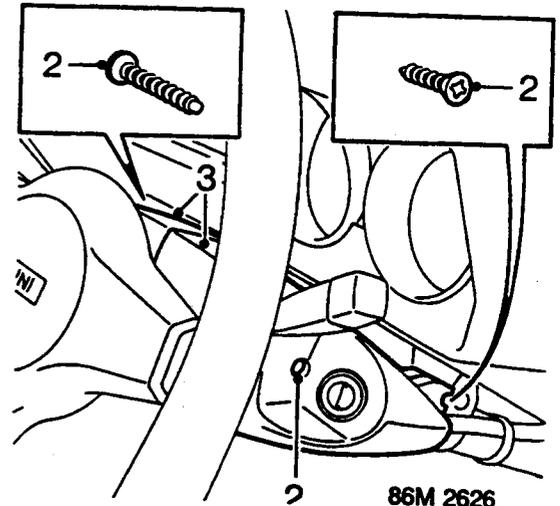

2. Remove 3 screws securing 2 halves of nacelle to steering column.
3. Remove steering column nacelle.

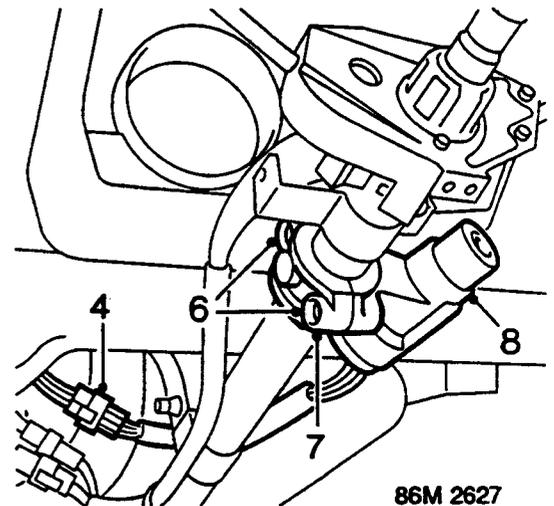

4. Disconnect ignition/starter switch from main harness.
5. Mark shear bolt heads with centre punch.
6. Drill out shear bolt heads.
7. Remove lock saddle from column.
8. Remove lock assembly from column.

Refit

1. Position steering lock assembly to column.
2. Fit steering lock saddle.
3. Fit but do not tighten 2 new shear bolts.
4. Ensure steering column moves freely and steering lock engages correctly.
5. Tighten shear bolts till the heads break off.
6. Connect ignition/starter switch to main harness.
7. Position 2 halves of steering column nacelle and secure with screws.
8. Connect battery earth lead.

ELECTRICAL

COLUMN SWITCHES

Service Repair No. 86.65.55

Remove

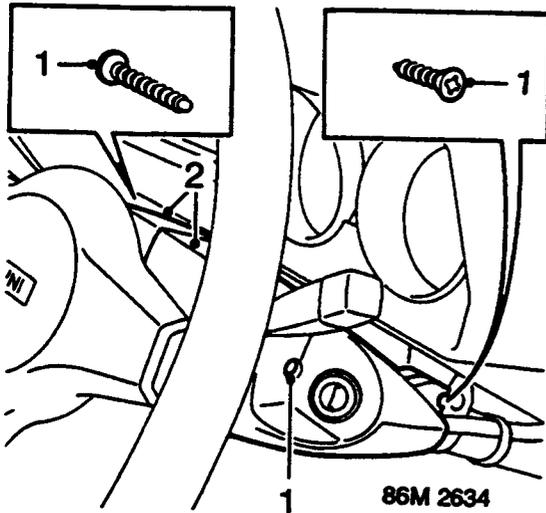

1. Remove 3 screws securing 2 halves of steering column nacelle to column.
2. Remove steering column nacelle.
3. Remove steering wheel, see **STEERING - Repairs**.

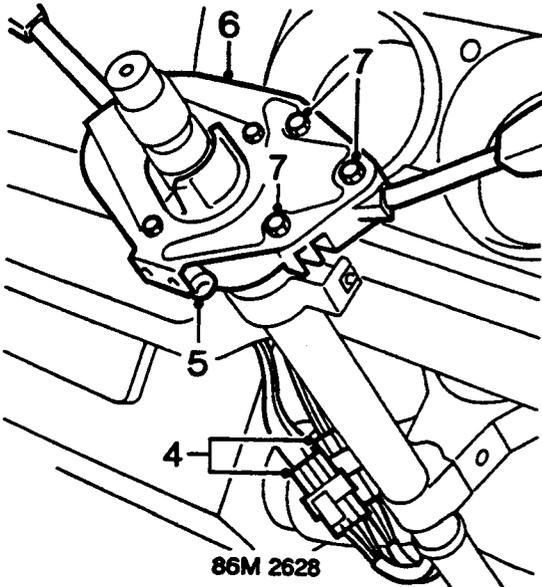

4. Disconnect column switch multiplugs from main harness.
5. Slacken screw securing switch assembly to column.
6. Withdraw switch assembly from column.
7. Remove 3 bolts securing wiper/washer switch to mounting plate.
8. Remove insulating tape securing the 2 switch harnesses together.

Refit

1. Position wiper/washer switch to switch mounting plate and secure with bolts.
2. Tape the 2 switch harnesses together with insulating tape.

3. Position switch assembly to steering column.
4. Ensure that striker dog on nylon switch centre is in line with and adjacent to indicator switch stalk.
5. Tighten clamp screw to secure switch assembly to column.
6. Connect column switch multiplugs to harness.
7. Position 2 halves of steering column nacelle to column and secure with screws.
8. Fit steering wheel, see **STEERING - Repairs**.

PANEL SWITCH

Service Repair No. 86.65.06

Remove

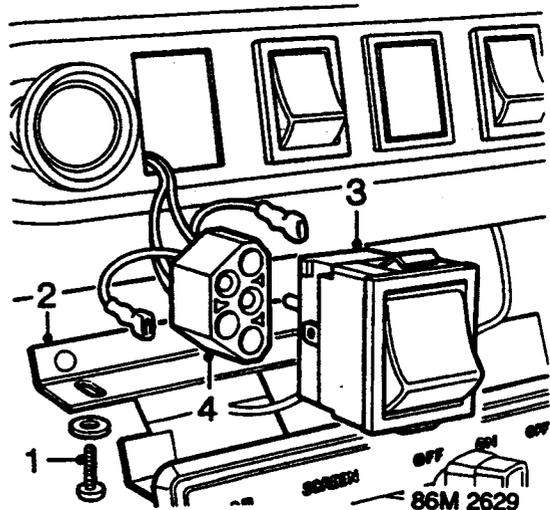

1. Remove 2 screws securing front of heater to fascia.
2. Lower heater assembly from fascia.
3. From behind, push switch out of switch panel.
4. Disconnect switch multiplug and Lucars.

Refit

1. Connect multiplug and Lucars to switch.
2. Secure switch to switch panel.
3. Raise heater and secure with screws to fascia.



STOP LAMP SWITCH

Service Repair No. 86.65.51

Remove

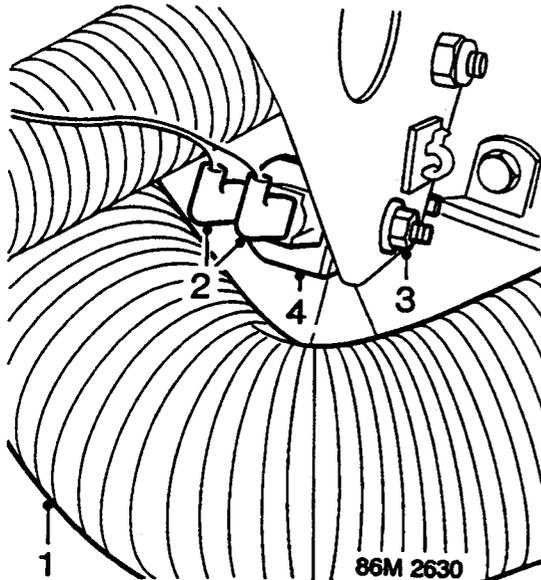

1. Release fresh air duct from heater and bulkhead.
2. Disconnect 2 Lucars from stop lamp switch.
3. Remove nut and washer securing stop lamp switch bracket to body.
4. Depress foot pedal and remove stop lamp switch and bracket.

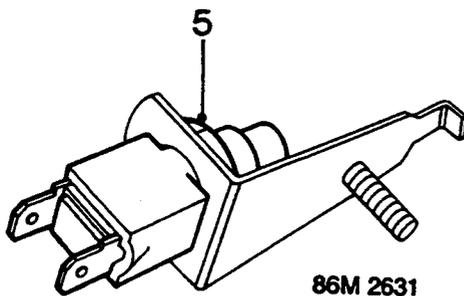

5. Remove nut securing stop lamp switch to bracket.

Refit

1. Fit stop lamp switch to bracket and secure with nut.
2. Depress foot pedal and fit stop lamp bracket to body.
3. Fit securing nut and washer but do not tighten.
4. Connect Lucars to stop lamp switch.
5. Adjust position of stop lamp switch bracket so that the lights come on when the pedal is pressed.
6. Tighten nut to secure stop lamp bracket in position.

DIM - DIP RESISTOR

Service Repair No. 86.55.92

Remove

1. Disconnect battery earth lead.
2. Raise the bonnet.

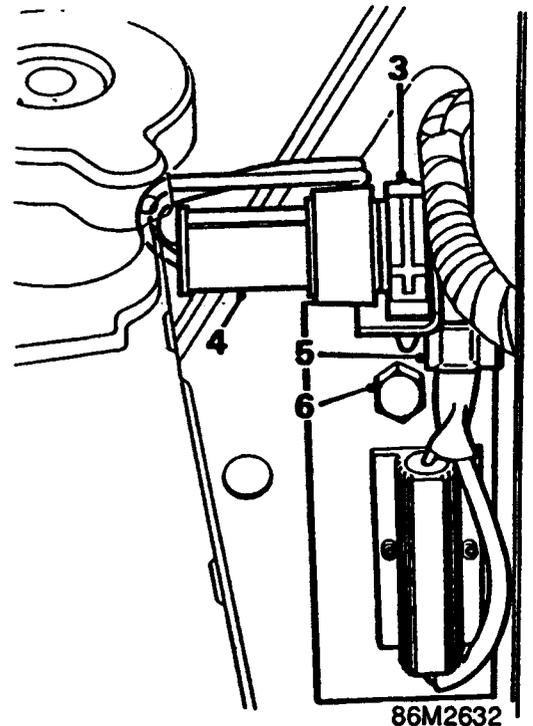

3. Release harness connector from retaining clip.
4. Disconnect resistor from harness connector.
5. Release resistor harness from retaining clip.
6. Remove bolt securing resistor mounting plate to body and withdraw from vehicle.

Refit

1. Position resistor to body, fit securing bolt and tighten to 9 Nm.
2. Connect resistor to harness.
3. Secure harness and connector to retaining clips.
4. Connect battery earth lead.

RADIO CASSETTE PLAYER

Service Repair No. 86.50.03

Remove

1. Deactivate security code.
2. Disconnect battery earth lead.

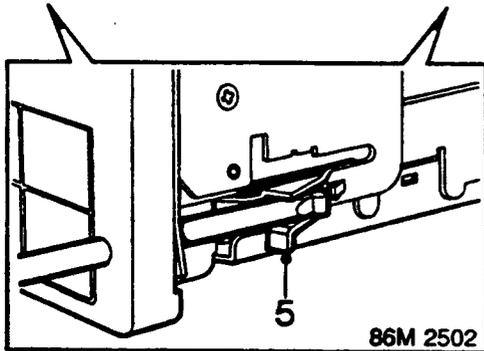
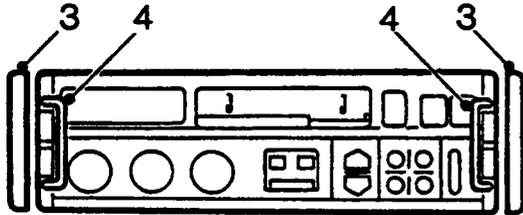

3. Carefully prise the side finishers (if fitted) from either side of the unit.
4. Insert 2 halves of radio removal tool **SMD 4091**, one into each pair of holes at edge of unit.
5. Engage retaining clip lugs (two each side).

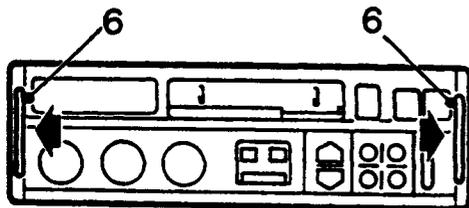

86M 2503

6. Press radio removal tool **SMD 4091**, outwards to depress clips.
7. Pull radio removal tool **SMD 4091**, to release radio cassette player from fascia.
8. Withdraw radio cassette player from fascia sufficient to gain access to multiplugs and aerial lead.
9. Remove 2 halves of radio removal tool **SMD 4091**.

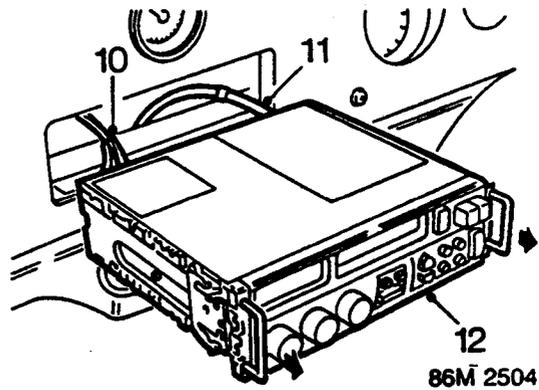

10. Disconnect multiplugs from unit.
11. Disconnect aerial lead from unit.
12. Remove radio cassette player.

Refit

1. Position radio cassette player in front of aperture in fascia.
2. Connect aerial lead to unit.
3. Connect multiplugs to unit.
4. Slide radio cassette player into fascia until retaining clips are engaged.
5. Refit side finishers to unit (if fitted).
6. Connect battery earth lead.
7. Activate security code.
8. Check radio cassette player for correct operation.



FRONT SPEAKER

Service Repair No. 86.50.15

Remove

1. Open door.

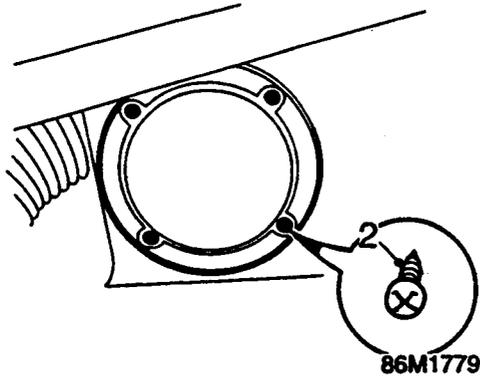

2. Remove 4 screws securing speaker to bulkhead.

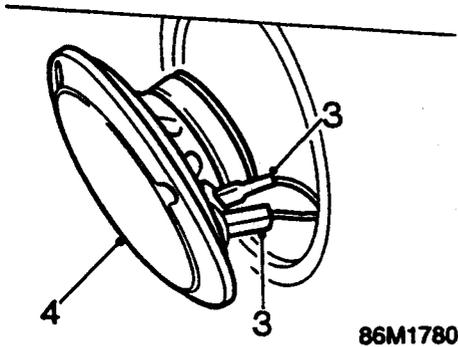

3. Release speaker and disconnect 2 connectors.
4. Remove speaker.

Refit

1. Connect speaker leads.
2. Align speaker to bulkhead.
3. Fit and tighten 4 screws securing speaker.
4. Close the door.

HEEL BOARD SPEAKER

Service Repair No. 86.50.12

Remove

1. Move front seat squab forward for access to speakers.

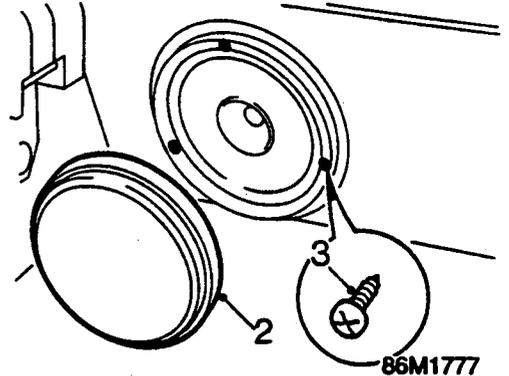

2. Remove speaker grille by carefully levering under the edge.
3. Remove 3 screws securing speaker to heel board.

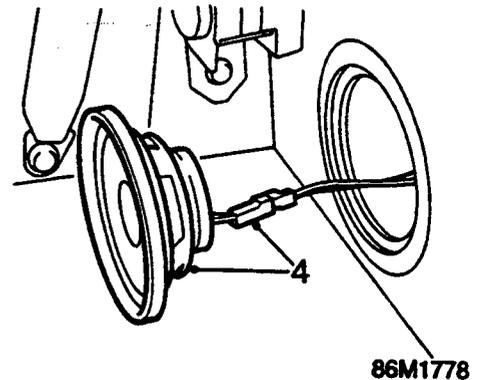

4. Release speaker from heel board, disconnect multiplug and remove speaker.

Refit

1. Position speaker connect multiplug and align speaker to heel board.
2. Fit and tighten 3 screws securing speaker to heel board.
3. Fit speaker grille.
4. Reposition front seat.

ELECTRICAL

REAR SPEAKER

Service Repair No. 86.50.12

Remove

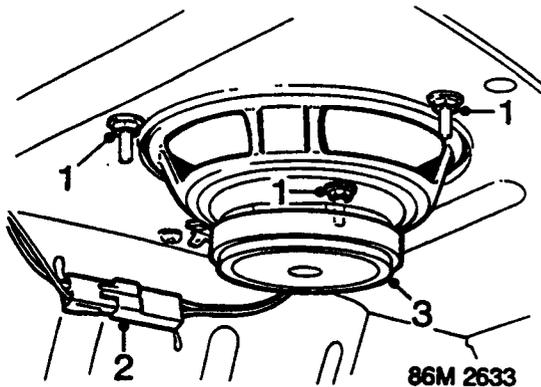

1. Remove 3 nuts securing rear speaker to rear shelf.
2. Lift speaker and disconnect multiplug.
3. Remove speaker from rear shelf.

Refit

1. Position speaker to rear shelf.
2. Connect multiplug to speaker.
3. Fit and tighten speaker retaining nuts.

ECU - ANTI-THEFT

Service Repair No. 86.55.95

Remove

1. Open passenger door.
2. *Models with wooden fascia:* Remove fascia assembly, see **BODY - Repairs**.

Models Without Wooden Fascia

3. Remove LH face level vent trim retaining ring.
4. Remove LH face level vent trim.
5. Remove LH face level vent.
6. Release door seal from 'A' post to clear bulkhead trim.
7. Remove 2 edge clips securing bulkhead trim to 'A' post.
8. Release bulkhead trim from instrument pack and fold down for access to ECU.

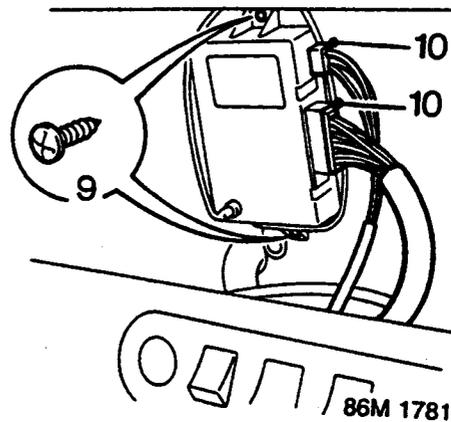

All Models

9. Remove 2 screws securing ECU to bracket.
10. Disconnect 2 multiplugs from ECU.

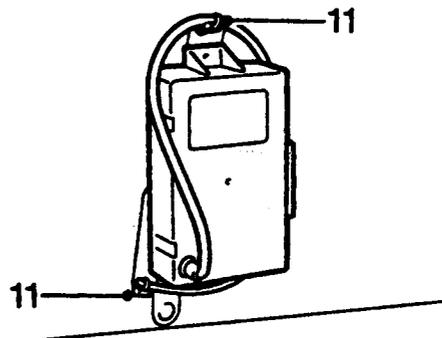

11. Cut 2 straps securing ECU receiver lead to ECU bracket.
12. Remove ECU.

Refit

1. Fit ECU to bulkhead and align receiver lead to ECU bracket.
2. Fit 2 straps securing receiver lead to bracket.
3. Connect 2 multiplugs to ECU.
4. Align ECU to its bracket and fit and tighten 2 screws.
5. *Models with wooden fascia:* Fit fascia assembly, see **BODY - Repairs**.

Models Without Wooden Fascia

6. Align trim panel to bulkhead and instrument pack.
7. Fit 2 edge clips to secure trim to 'A' post.
8. Refit door seal.
9. Fit face level vent, fit trim over vent and fit trim securing ring.
10. Close passenger door.



BONNET SWITCH - ANTI - THEFT

Service Repair No. 86.55.89

Remove

1. Open bonnet.

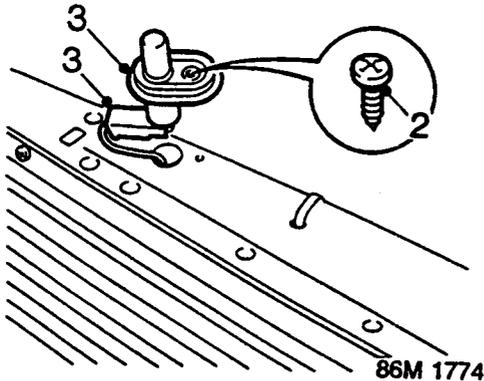

2. Remove screw securing switch to bonnet locking platform.
3. Release switch from platform, disconnect Lucar and remove switch.

Refit

1. Connect Lucar to switch.
2. Align switch to bonnet locking platform and fit and tighten screw.

BOOT SWITCH - ANTI - THEFT

Service Repair No. 86.55.80

Remove

1. Open luggage compartment lid.

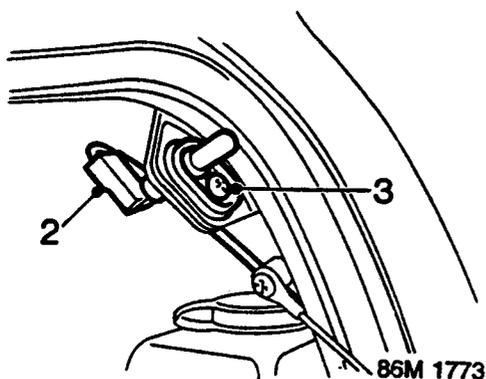

2. Disconnect Lucar from switch.
3. Remove screw and switch from bracket.

Refit

1. Fit switch to bracket and tighten screw.
2. Connect Lucar.

VOLUMETRIC SENSOR

Service Repair No. 86.55.94

Remove

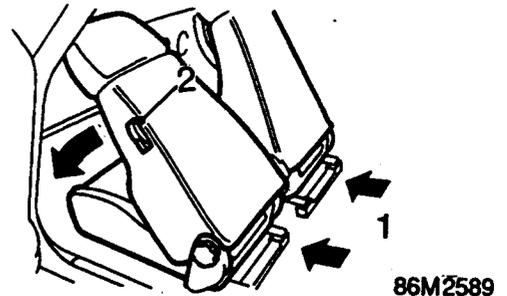

1. Slide both front seats fully forward.
2. Release front seat squab levers and pull squabs forward.
3. Release rear seat cushion from rear seat panel.
4. Remove heel board speakers, see **Heel board speaker**.
5. Release and remove heel board.

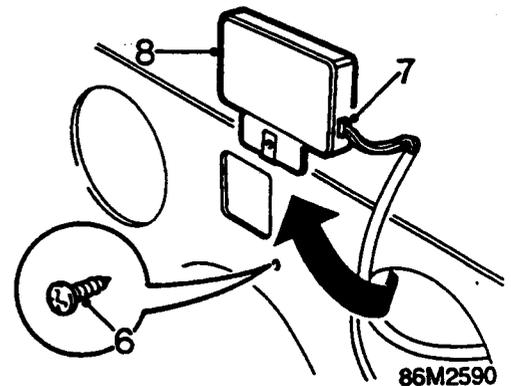

6. Remove screw securing volumetric sensor to heel board panel.
7. Withdraw volumetric sensor and disconnect harness multiplug.
8. Remove volumetric sensor.

Refit

1. Connect multiplug to volumetric sensor.
2. Position volumetric sensor to heel board panel, fit and tighten screw.
3. Refit heel board.
4. Fit heel board speakers, see **Heel board speakers**.
5. Fit rear seat cushion into position.
6. Return front seats to their original position.

ELECTRICAL

INTRODUCTION

The circuit diagrams are for Mini models from 1992 on, fitted with anti-theft alarms. The circuit diagrams are shown as specific system diagrams, e.g. Power distribution circuit, Engine management circuit, Instruments etc.

Note: Ensure the correct manual is used when carrying out diagnosis and repairs.

Interconnections from one circuit to another are shown by a triangular symbol identified by a (lower case) letter. Outputs are shown with the lead connected to the base of the triangular symbol and inputs are shown with the lead connected to the apex of the triangular symbol.

FUSES

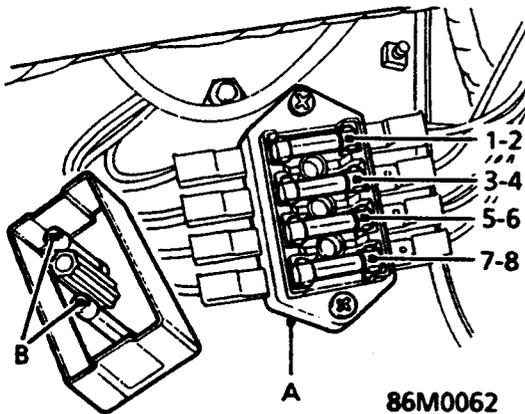

- A. Fuse box
- B. Spare fuses

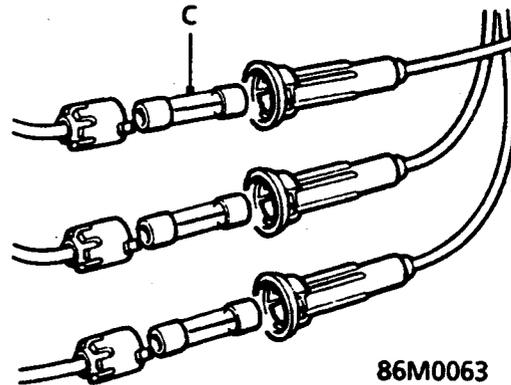

- C. Line fuses

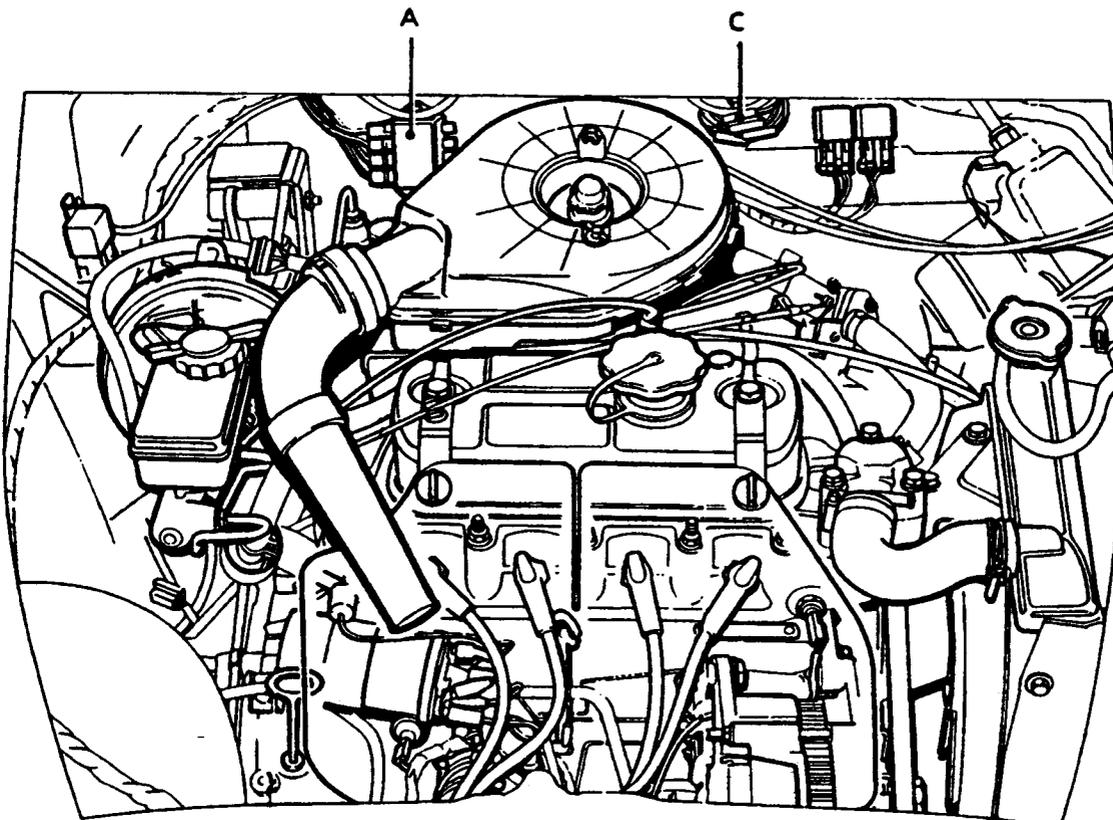

86M0064



FUSE BOX DETAILS

Fuse No.	Wire Colour	Rating	Function
1-2	W - G	35 amp	Brake lamps, reverse lamps, Direction indicator relay, Rear screen demister, Headlamp dim dip relay.
3-4	N - P	25 amp	Horn, Headlamp flasher, Brake failure circuit, Radio memory.
5-6	LG/W - LG/O	25 amp	Heater blower motor, Windscreen wipers, Washer motor, Instruments, Auxiliary cooling fan relay.
7-8	R - R/B	15 amp	L.H. side and rear lamps; Panel lights, Headlamp dim dip relay

LINE FUSE DETAILS

Fuse No.	Wire Colour	Rating	Function	Location
LF1	N - P/O	15 amp	Direction indicator/Hazard warning lamps, Interior lamps.	Under bonnet
LF2	U - U/O	10 amp	Rear fog guard lamps	Under bonnet
LF3	N - N/O	15 amp	Dim dip lighting.	Under bonnet
LF4	N/S - N/S	10 amp	Fuel pump	Under bonnet
LF5	N - P	15 amp	Auxiliary cooling fan relay.	Under bonnet
LF6	R - R/W	15 amp	R.H. side and rear lamps.	Under bonnet
LF7	W - W	10 amp	Instruments, Anti - theft alarm Engine management	Under bonnet
LF8	U/R - U/R	15 amp	R.H headlamp dip beam	Behind fascia
LF9	U/W - U/W	15 amp	R.H headlamp main beam	Behind fascia
LF10	U/R - U/R	15 amp	L.H headlamp dip beam	Behind fascia
LF11	U/W - U/W	15 amp	L.H headlamp main beam	Behind fascia
LF12	L/G - L/G	5 amp	Radio/cassette Clock illumination	Under dashboard
LF13	W - R	25 amp	Fabric sun roof	Under bonnet
LF14	P - P	15 amp	Driving lamps	Under bonnet
LF15	U/R - UK	5 amp	Headlamp levelling (if fitted)	Under bonnet locking platform

ELECTRICAL

Power Distribution - Carburetter models

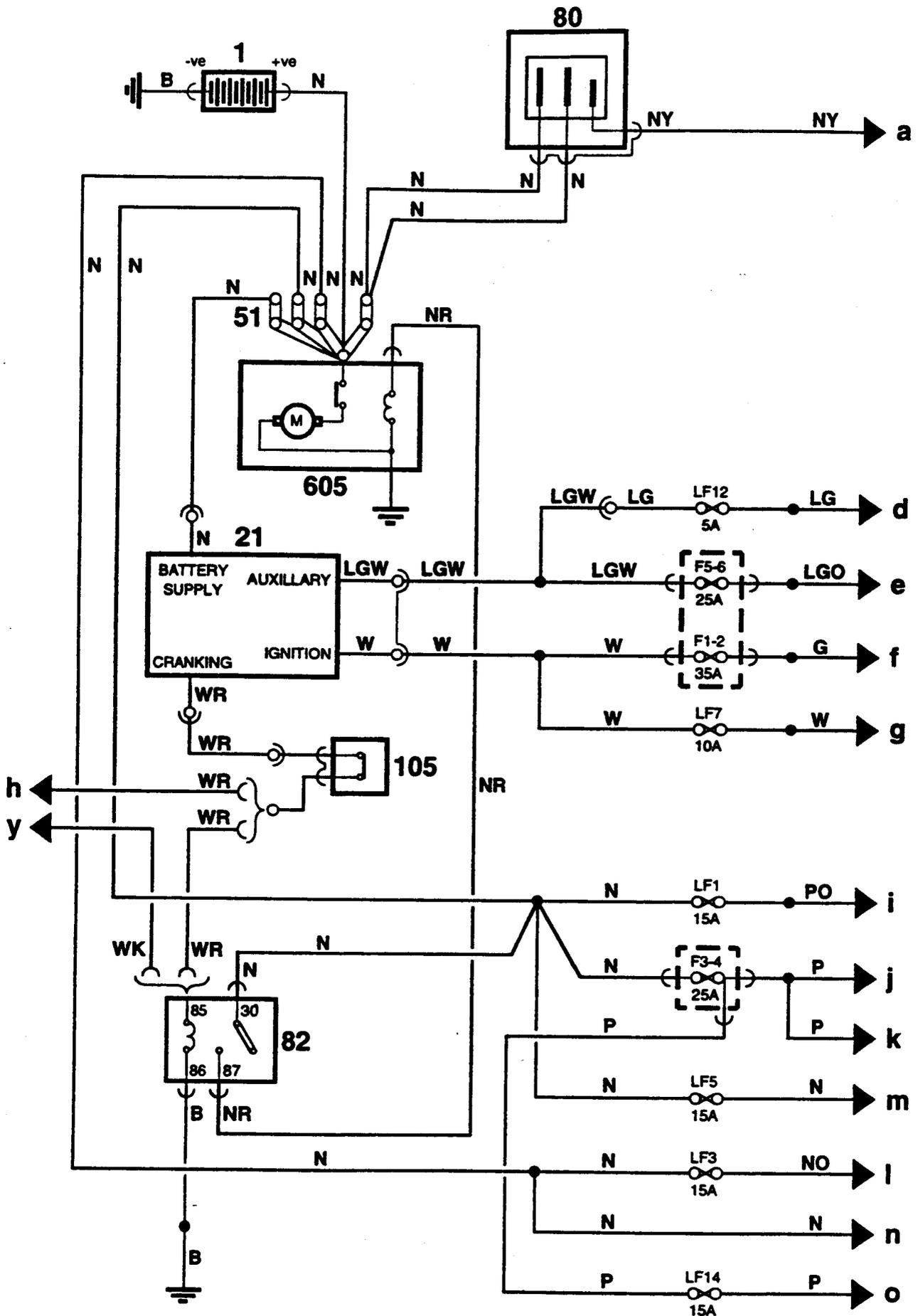

86M2562



POWER DISTRIBUTION CIRCUIT - CARBURETTOR MODELS

- 1. Battery
- 21. Ignition switch
- 51. Fusible links (cables)
- 80. Alternator
- 82 Starter relay
- 105 Automatic inhibitor switch
- 605. Starter
- F. Fuse
- LF. Line fuse

Connections to other circuits

- a. Instrument
- d. Radio/cassette player
- e. Wash wipe
Heater
Instrument
Auxiliary cooling fan
Automatic gearbox selector illumination
- f. Reverse lamps, brake lamps and heated rear window
Direction indicator and hazard warning
Exterior lamps and horn
- g. Engine management
Instrument
Anti - theft alarm
- h. Anti - theft alarm
- i. Interior lamp
Direction indicator and hazard warning
Anti - theft alarm
- j. Exterior lamps and horn
Radio/cassette player
Anti - theft alarm
- k. Brake test
- l. Exterior lamps and horn
- m. Auxiliary cooling fan
- n. Exterior lamps and horn
- o. Driving lamps (if fitted)
- y. Anti - theft alarm

ELECTRICAL

Power Distribution - SPi models

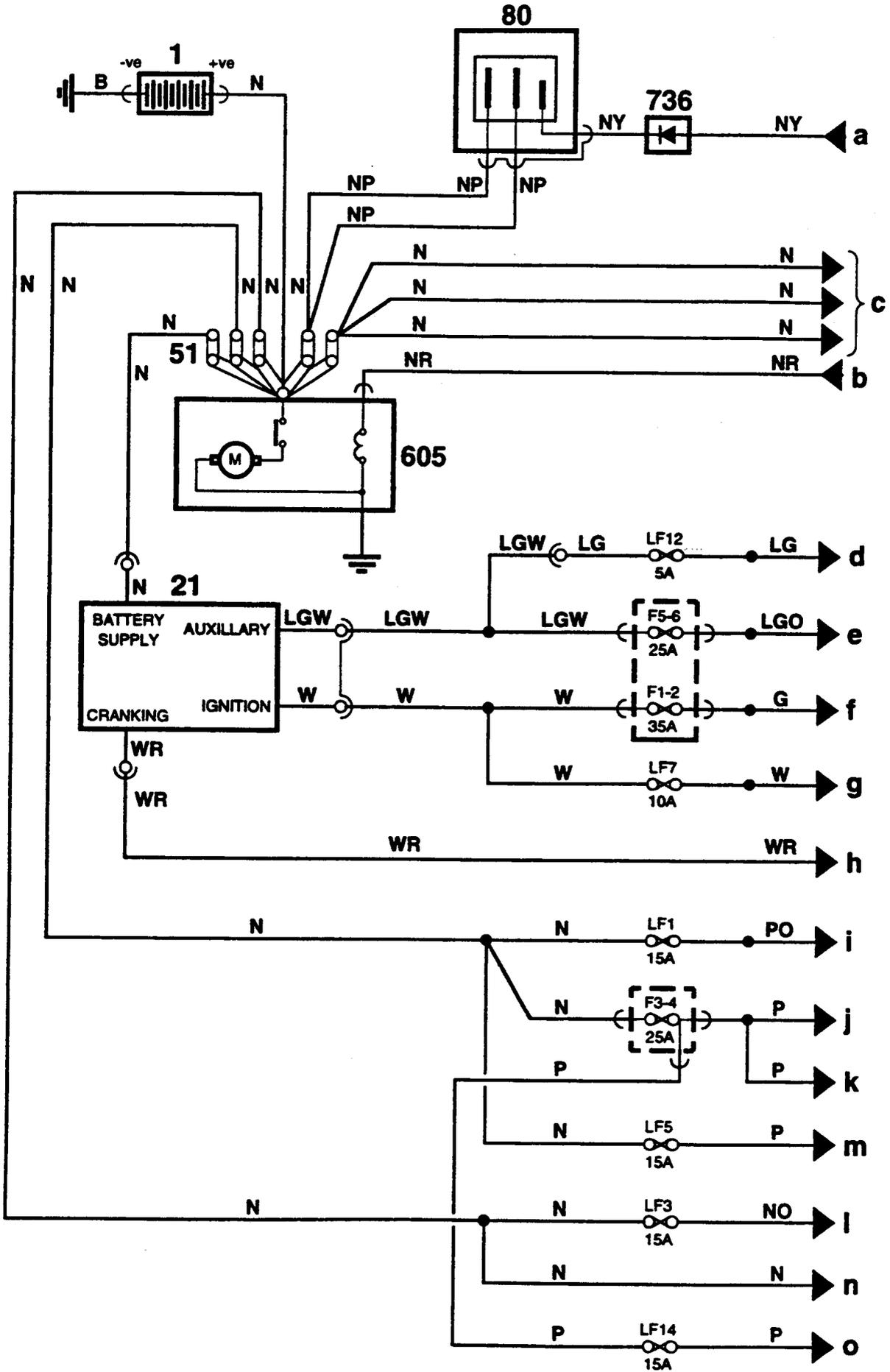

86M2592



POWER DISTRIBUTION CIRCUIT - SPi MODELS

- 1. Battery
- 21. Ignition switch
- 51. Fusible links (cables)
- 80. Alternator
- 605. Starter
- 736. Diode
- F. Fuse
- LF. Line fuse

Connections to other circuits

- a. Instrument
- b. Engine management (starter relay)
- c. Engine management
- d. Radio/cassette player
- e. Wash wipe
Heater
Instrument
Auxiliary cooling fan
Automatic gearbox selector illumination
- f. Reverse lamps, brake lamps and heated rear window
Direction indicator and hazard warning
Exterior lamps and horn
- g. Engine management
Instrument
Anti - theft alarm
- h. Anti - theft alarm
- i. Interior lamp
Direction indicator and hazard warning
Anti - theft alarm
- j. Exterior lamps and horn
Radio/cassette player
Anti - theft alarm
- k. Brake test
- l. Exterior lamps and horn
- m. Auxiliary cooling fan
- n. Exterior lamps and horn
- o. Driving lamps (if fitted)

ELECTRICAL

Exterior Lamps and Horn

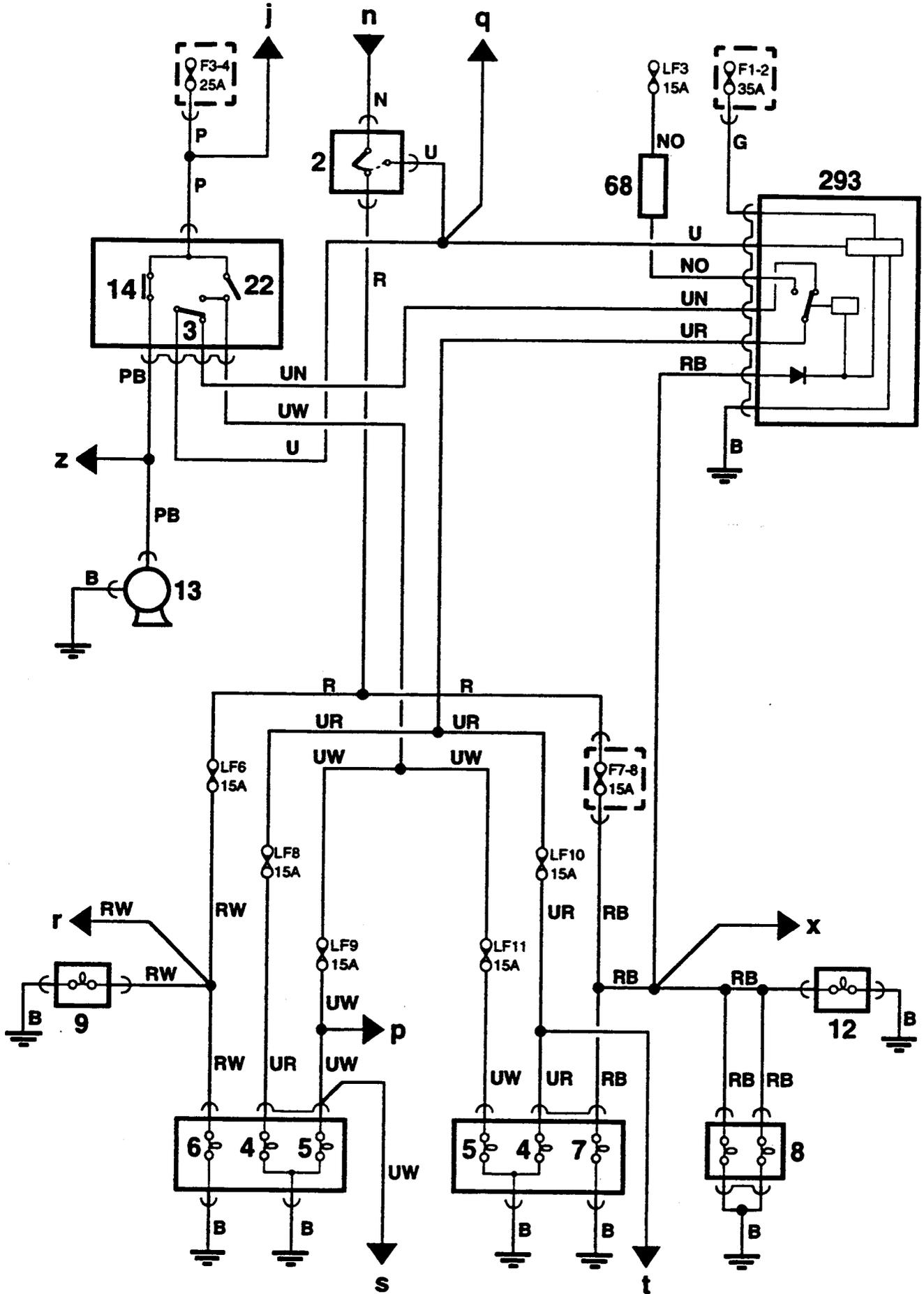

86M2563

**EXTERIOR LAMPS AND HORN CIRCUIT**

- 2. Lighting switch
- 3. Dip switch
- 4. Dip beam headlamp
- 5. Main beam headlamp
- 6. RH side lamp
- 7. LH side lamp
- 8. Number plate illumination lamp
- 9. RH tail lamp
- 12. LH tail lamp
- 13. Horn
- 14. Horn switch
- 22. Headlamp flash switch
- 68. Dim dip resistor
- 293. Dim dip relay

- F. Fuse
- LF. Line fuse

Connections to other circuits

- n. Power distribution
- p. Instrument
- q. Fog lamp
- r. Instrument
- j. Power distribution
- s. Driving lights
- t. Headlamp levelling
- x. Headlamp levelling
- z. Anti - theft alarm

ELECTRICAL

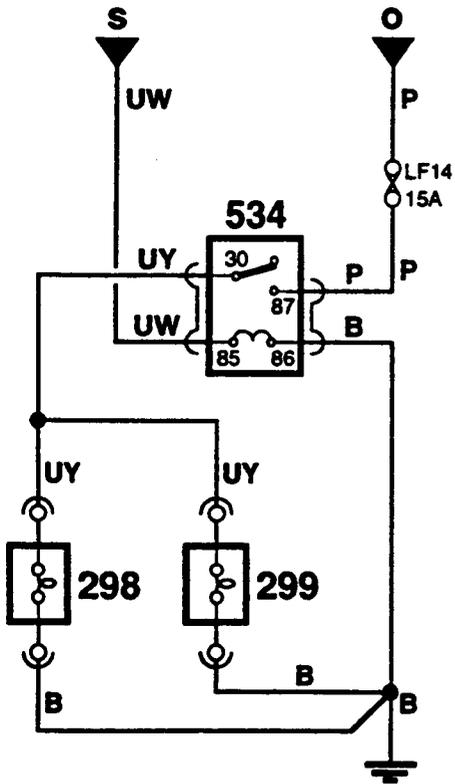

86M2564

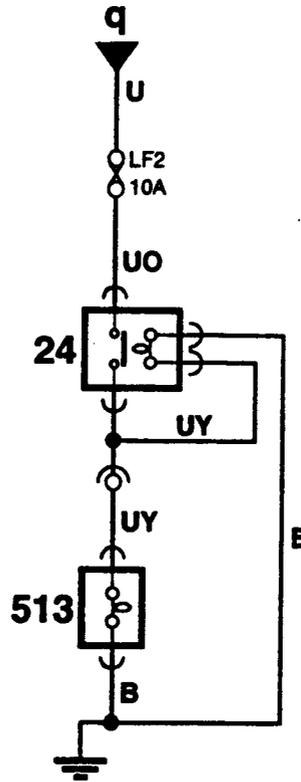

86M2565

DRIVING LAMPS CIRCUIT

- 298. RH Driving lamp
- 299. LH Driving lamp
- 534. Driving lamp relay

- F. Fuse
- LF. Line fuse

Connections to other circuits

- o. Power distribution
- s. Exterior lamps and horn

FOG LAMP CIRCUIT

- 24. Rear fog lamp switch
- 513. Rear fog lamp

- F. Fuse
- LF. Line fuse

Connections to other circuits

- q. Exterior lamps and horn

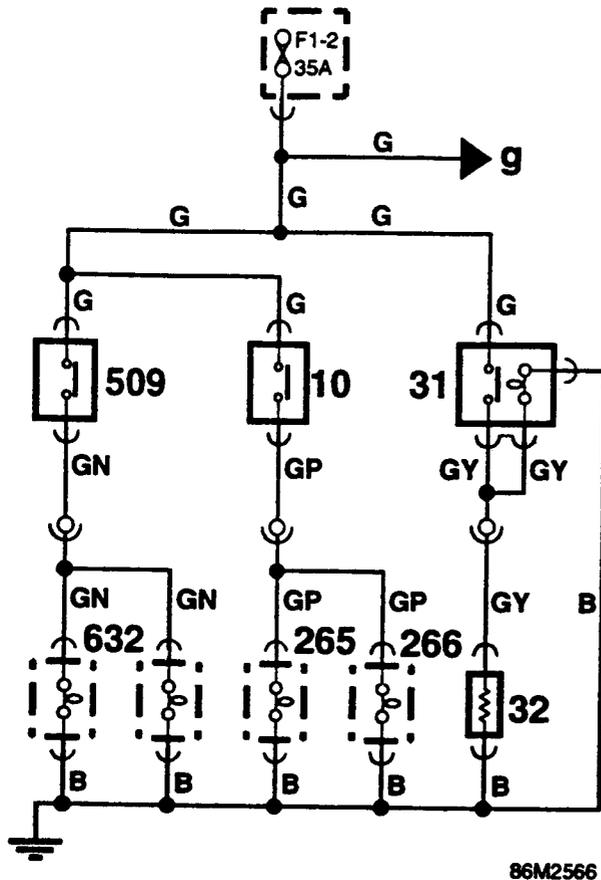

86M2566

REVERSE LAMPS, BRAKE LAMPS AND HEATED REAR WINDOW CIRCUIT

- 10. Brake lamp switch
- 31. Heated rear window switch
- 32. Heated rear window element
- 265. LH brake lamp
- 266. RH brake lamp
- 509. Reverse lamp switch
- 632. Reverse lamps

- F. Fuse
- LF. Line fuse

Connections to other circuits

- g. Power distribution

**DIRECTION INDICATOR AND HAZARD WARNING CIRCUIT**

- 15. Direction indicator switch
- 16. RH front direction indicator lamp
- 17. LH front direction indicator lamp
- 27. Direction indicator/hazard warning unit
- 33. Hazard warning light
- 34. Hazard switch
- 57. LH side repeater lamp
- 58. RH side repeater lamp
- 424. RH rear direction indicator lamp
- 425. LH rear direction indicator lamp
- 661. Direction indicator relay

- F. Fuse
- LF. Line fuse

Connections to other circuits

- f. Power distribution
- i. Power distribution
- v. Instrument
- w. Instrument
- aa. Anti - theft alarm
- ab. Anti - theft alarm

ELECTRICAL

Instruments

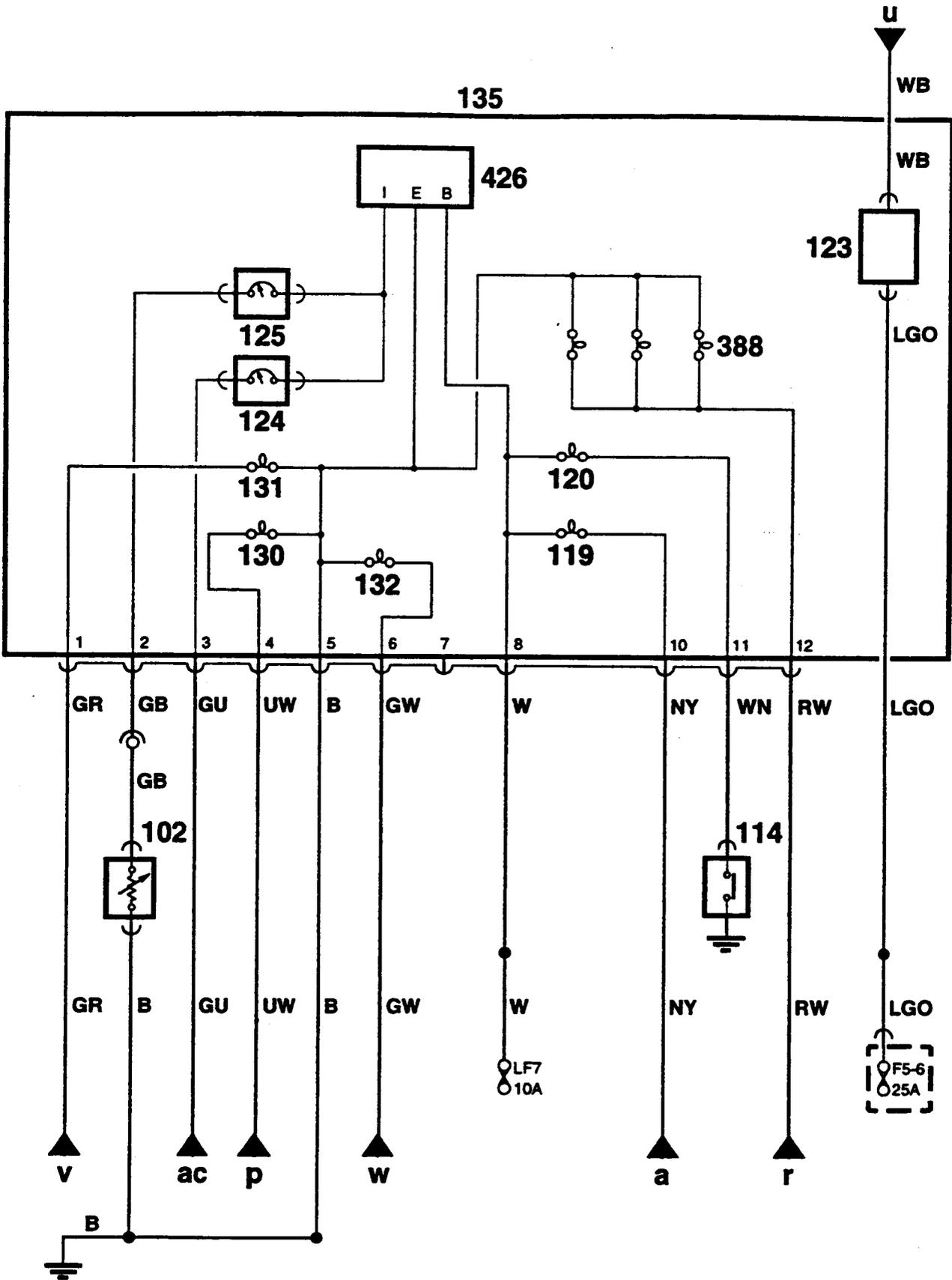

86M2567

**INSTRUMENT CIRCUIT**

- 102. Fuel gauge sender unit
- 114. Oil pressure switch
- 119. Ignition/no charge warning light
- 120. Oil pressure warning light
- 123. Tachometer
- 124. Coolant temperature gauge
- 125. Fuel gauge
- 130. Main beam warning light
- 131. LH indicator warning light
- 132. RH indicator warning light
- 135. Instrument pack
- 388. Instrument pack illumination
- 426. Voltage stabiliser

- F. Fuse
- LF. Line fuse

Connections to other circuits

- a. Power distribution
- p. Exterior lamps and horn
- r. Exterior lamps and horn
- u. Engine management
- v. Direction indicator and hazard warning
- w. Direction indicator and hazard warning
- ac. Engine management

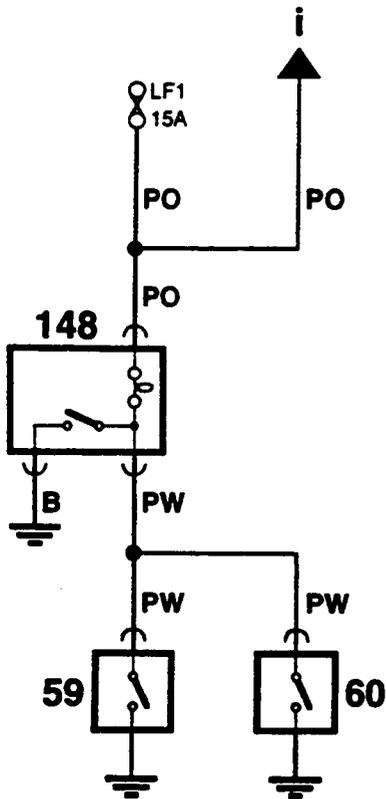

86M2569

INTERIOR LAMP CIRCUIT - (Saloon)

- 59. Drivers door switch
- 60. Passengers door switch
- 148. Interior lamp unit

- F. Fuse
- LF. Line fuse

Connections to other circuits

- i. Power distribution

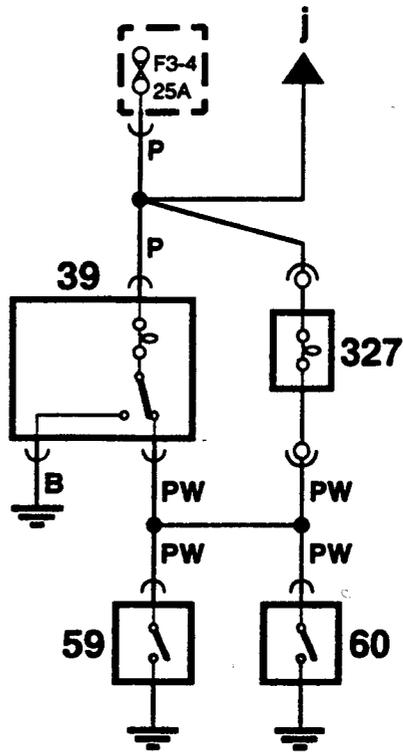

86M2570

INTERIOR LAMP CIRCUIT (Cabriolet)

- 39. Glove box light
- 59. Drivers door switch
- 60. Passengers door switch
- 327. RH Footwell light

- F. Fuse
- LF. Line fuse

Connections to other circuits

- j. Power distribution

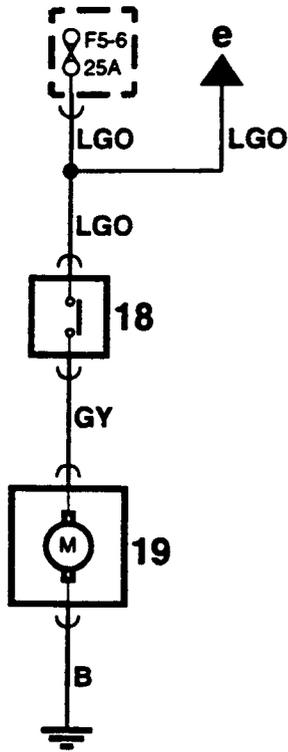

86M2571

HEATER CIRCUIT

- 18. Heater switch
- 19. Heater motor

- F. Fuse
- LF. Line fuse

Connections to other circuits

- e. Power distribution

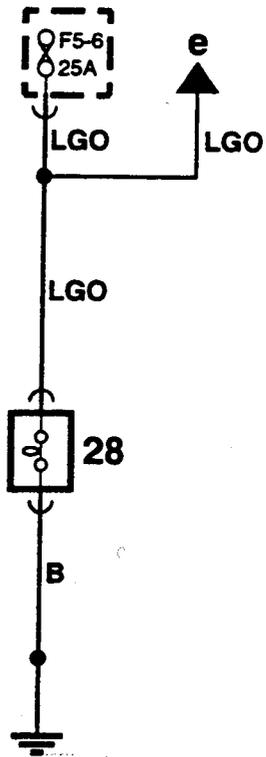

86M2572

AUTOMATIC GEARBOX SELECTOR ILLUMINATION CIRCUIT

- 28. Automatic gearbox selector indicator lamp.

- F. Fuse
- LF. Line fuse

Connections to other circuits

- e. Power distribution

ELECTRICAL

ENGINE MANAGEMENT CIRCUIT

82.	Starter relay
83.	Ignition coil
87.	Crank shaft sensor
93.	Throttle potentiometer
94.	Coolant temperature sensor
97.	Fuel pump relay
98.	Main relay
99.	Manifold heater relay
101.	Inertia switch
103.	Fuel pump
104.	Relay module
105.	Starter inhibitor switch (Automatic only)
110.	Diagnostic socket
111.	Stepper motor
113.	Manifold heater
138.	Inlet air temperature sensor
391.	Distributor
467.	Modular engine management control unit
468.	Oxygen sensor
497.	Purge valve
568.	Injector
628.	Oxygen sensor relay
F.	Fuse
LF.	Line fuse
SCR	Screened cable

Connections to other circuits

b.	Power distribution
c.	Power distribution
u.	Instrument
y.	Anti - theft alarm
ac.	Instrument



Engine Management

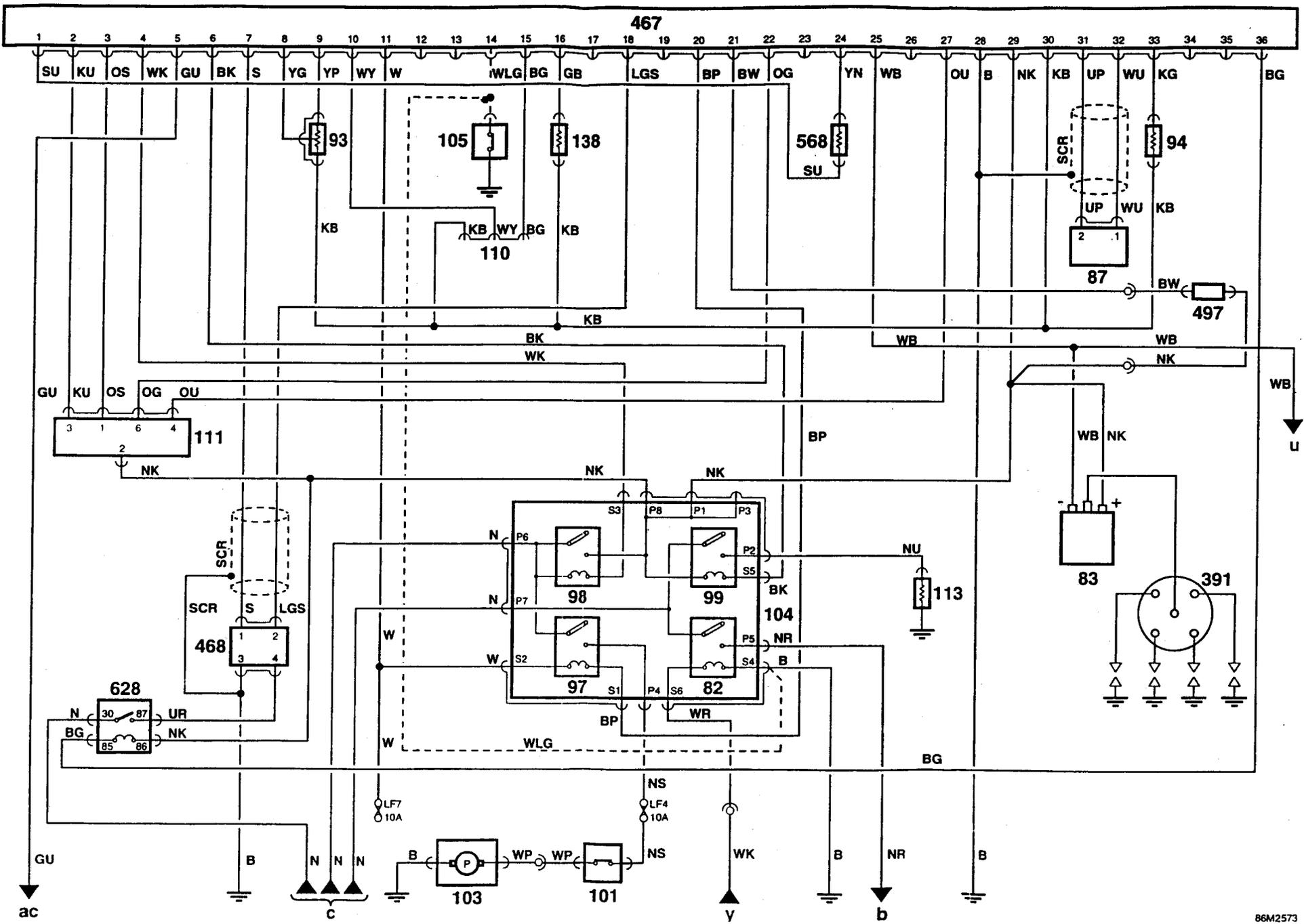

Anti-theft Alarm

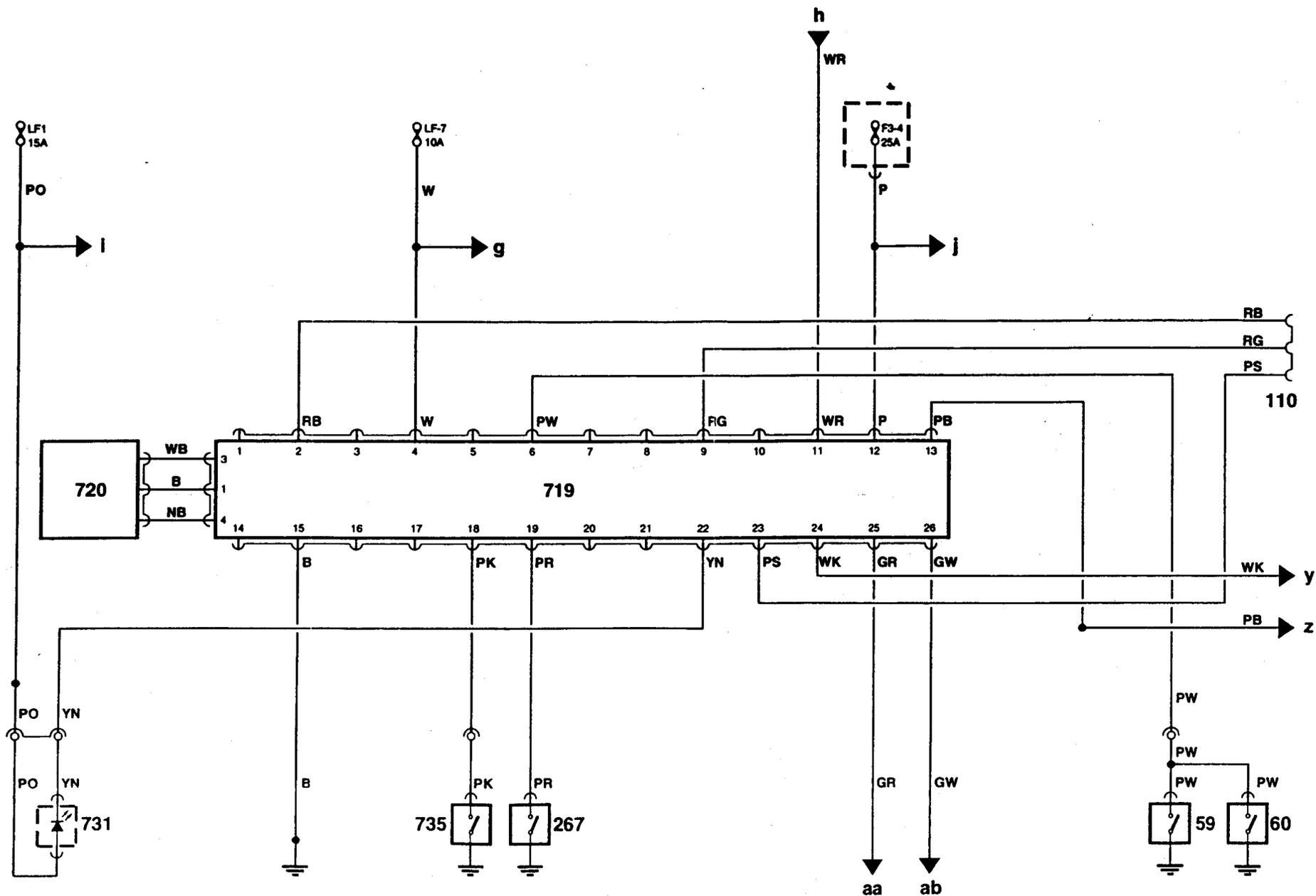

86M2574

**ANTI - THEFT ALARM CIRCUIT**

- 59. Drivers door switch
 - 60. Passengers door switch
 - 110 Diagnostic socket
 - 267. Bonnet switch
 - 719. Anti - theft alarm
 - 720. Volumetric sensor(Cabriolet only)
 - 731. Anti - theft alarm LED
 - 735. Boot switch
-
- F. Fuse
 - LF. Line fuse

Connections to other circuits

- g. Power distribution
- h. Power distribution
- i. Power distribution
- j. Power distribution
- y. Power distribution
- z. Exterior lamps and horn
- aa. Direction indicator and hazard warning
- ab. Direction indicator and hazard warning

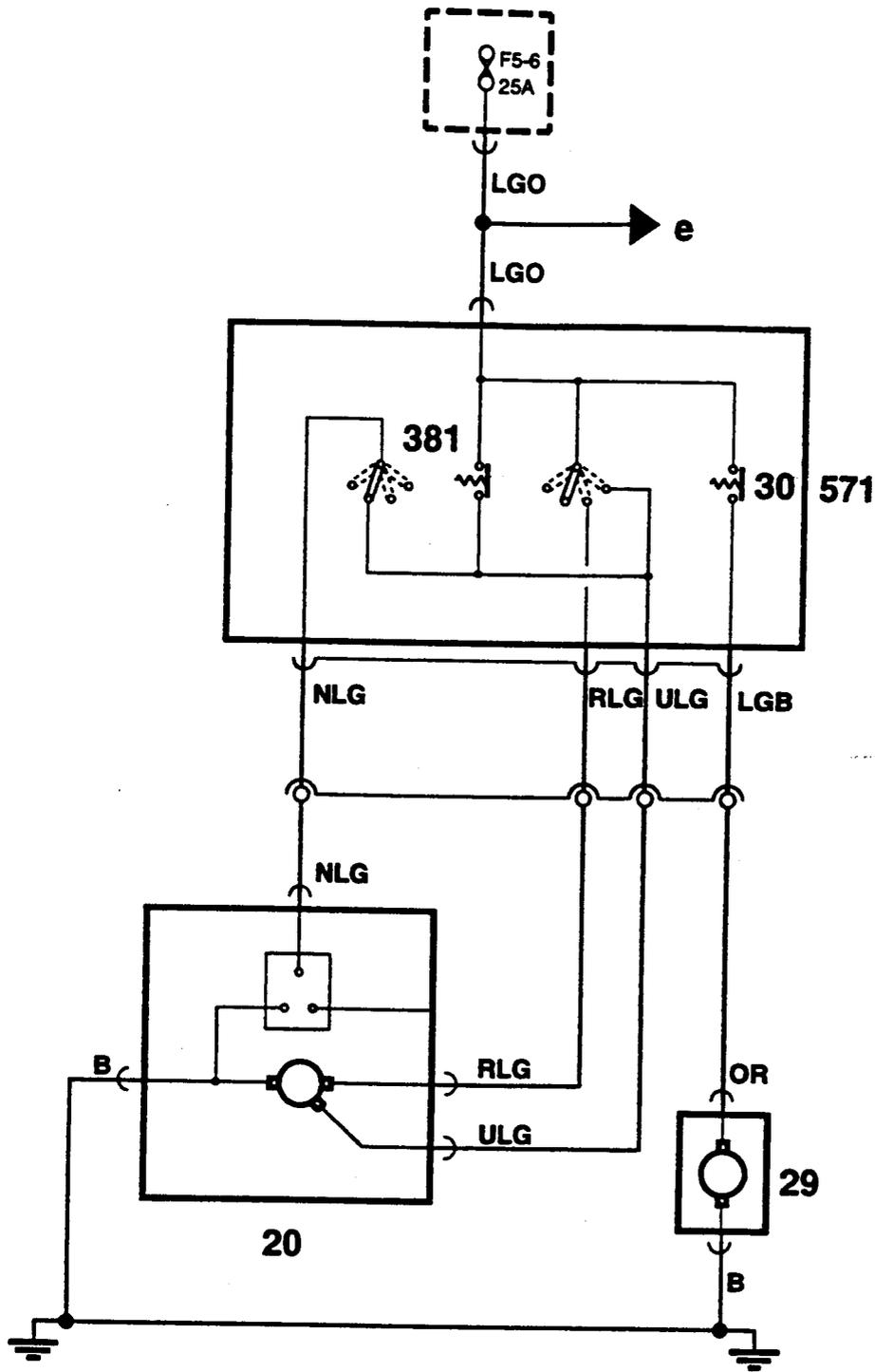

86M2575

WASH WIPE CIRCUIT

- 20. Windscreen wiper motor
- 29. Windscreen washer pump
- 30. Windscreen washer reservoir
- 381. Flick wiper switch
- 571. Wiper column switch

F. Fuse
LF. Line fuse

Connections to other circuits

e. Power distribution

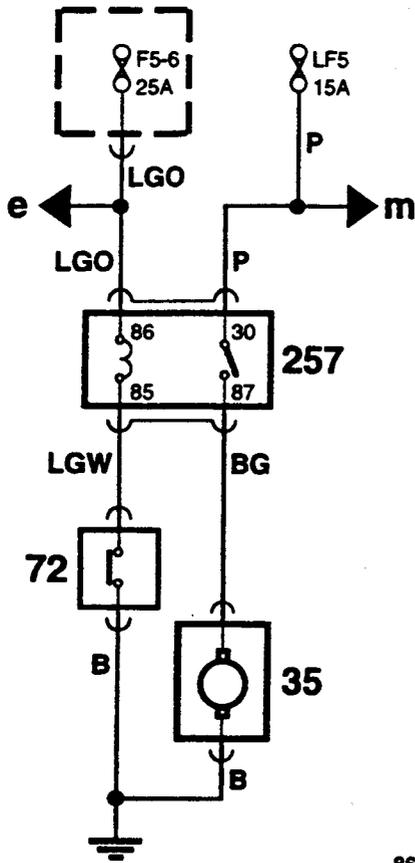

86M2576

AUXILIARY COOLING FAN CIRCUIT

- 35. Cooling fan
- 72. Coolant temperature switch
- 257. Cooling fan relay
- F. Fuse
- LF. Line fuse

Connections to other circuits

- e. Power distribution
- m. Power distribution

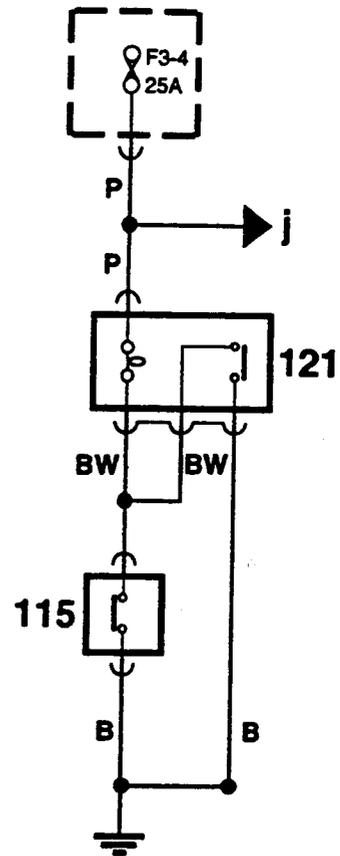

86M2579

BRAKE TEST CIRCUIT

- 115. Brake fluid level switch
- 121. Brake system warning light
- F. Fuse
- LF. Line fuse

Connections to other circuits

- j. Power distribution

ELECTRICAL

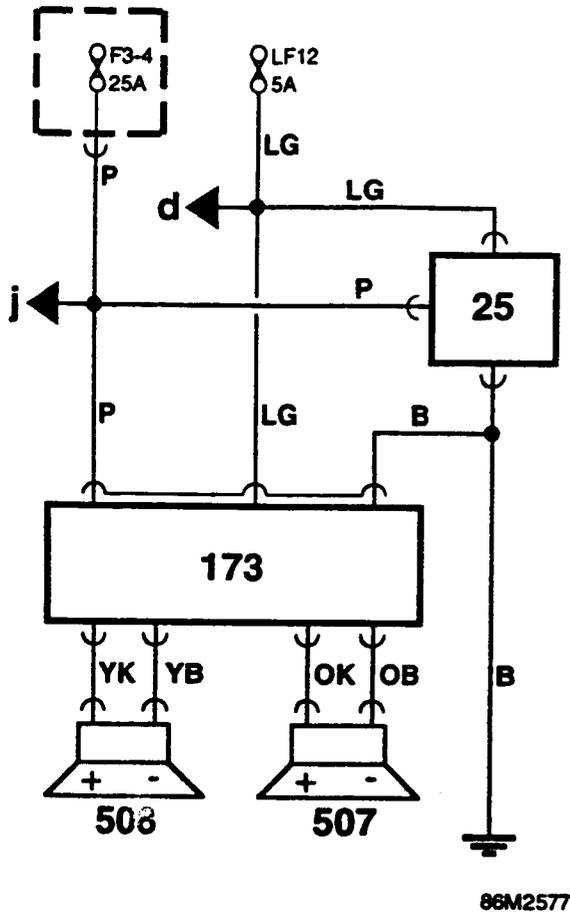

RADIO/CASSETTE PLAYER

2 Speaker system

- 25. Clock (if fitted)
- 173. Radio/cassette player
- 507. RH rear speaker
- 508. LH rear speaker

- F. Fuse
- LF. Line fuse

Connections to other circuits

- d. Power distribution
- j. Power distribution

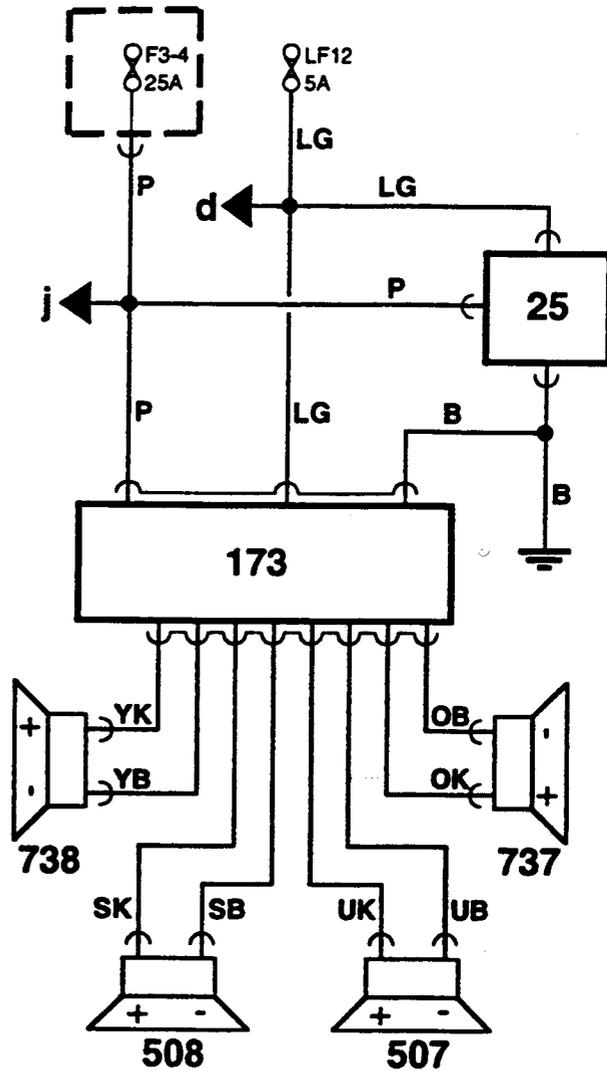

RADIO/CASSETTE PLAYER

4 Speaker system

- 25. Clock
- 173. Radio/cassette player
- 507. RH rear speaker
- 508. LH rear speaker
- 737. RH front speaker
- 738. LH front speaker

- F. Fuse
- LF. Line fuse

Connections to other circuits

- d. Power distribution
- j. Power distribution

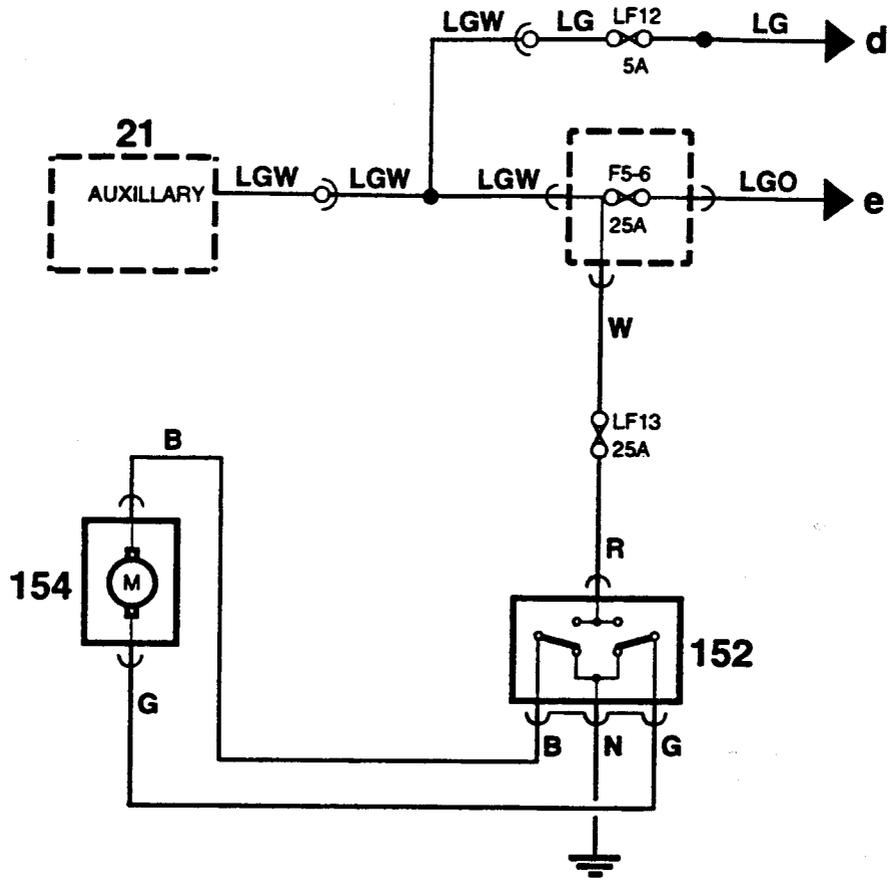

86M2580

SUN ROOF CIRCUIT

- 21. Ignition switch
- 152. Sun roof switch
- 154. Sun roof motor

- F. Fuse.
- LF. Line fuse

Connections to other circuits

- d. Power distribution
- e. Power distribution

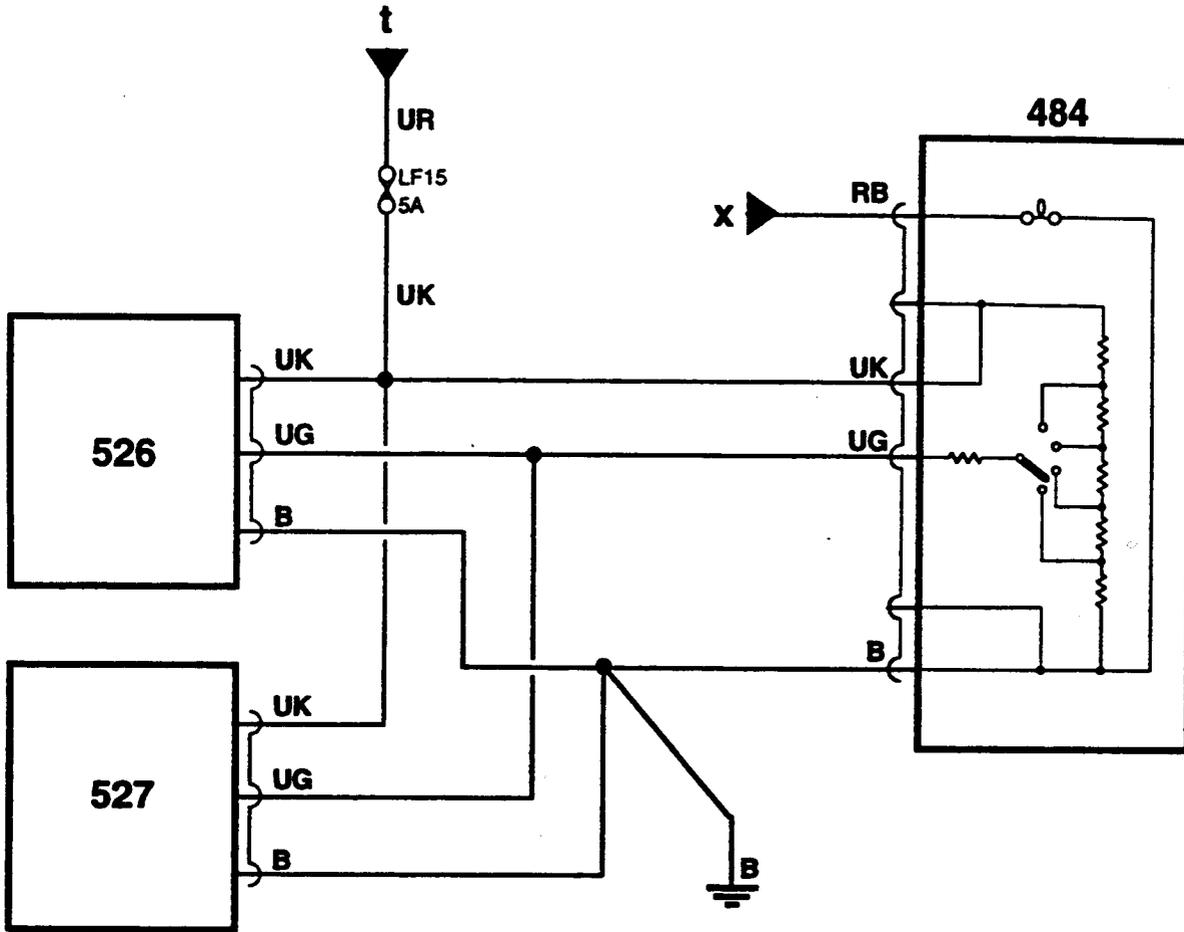

86M2581

HEADLAMP LEVELLING CIRCUIT (Germany)

- 484. Headlamp levelling switch
- 526. RH headlamp levelling motor
- 527. LH headlamp levelling motor

- F. Fuse.
- LF. Line fuse

Connections to other circuits

- t. Exterior lamps and horn
- x. Exterior lamps and horn

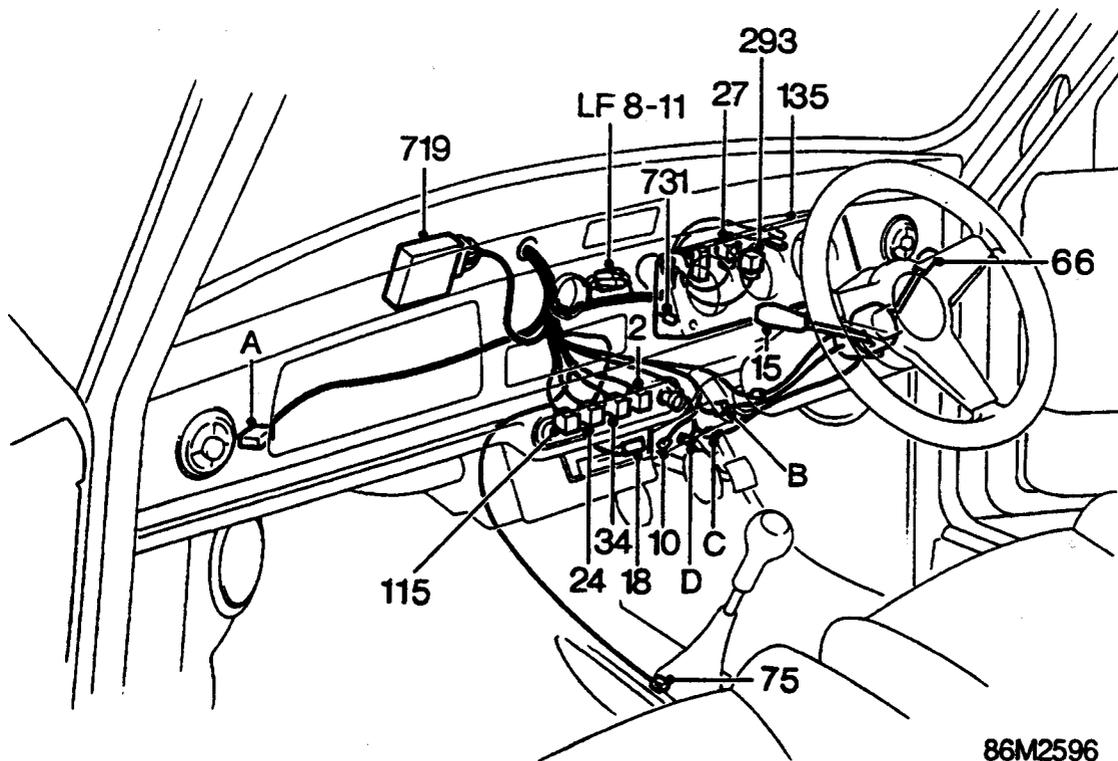

86M2596

Main harness - Passenger compartment

- 2 Brake lamp switch
- 15 Direction indicator switch
- 18 Heater switch
- 24 Rear fog lamp switch
- 27 Direction indicator/Hazard warning unit
- 34 Hazard warning switch
- 66 Wash/Wipe switch
- 75 Switch illumination
- 115 Brake fluid level switch
- 135 Instrument pack
- 293 Dim/Dip relay
- 719 Anti - theft alarm control unit
- 731 Anti - theft alarm indicator

- A Body harness connector
- B Column harness connector
- C Ignition switch connector
- D Radio harness connector
- E Wash/Wipe switch connector

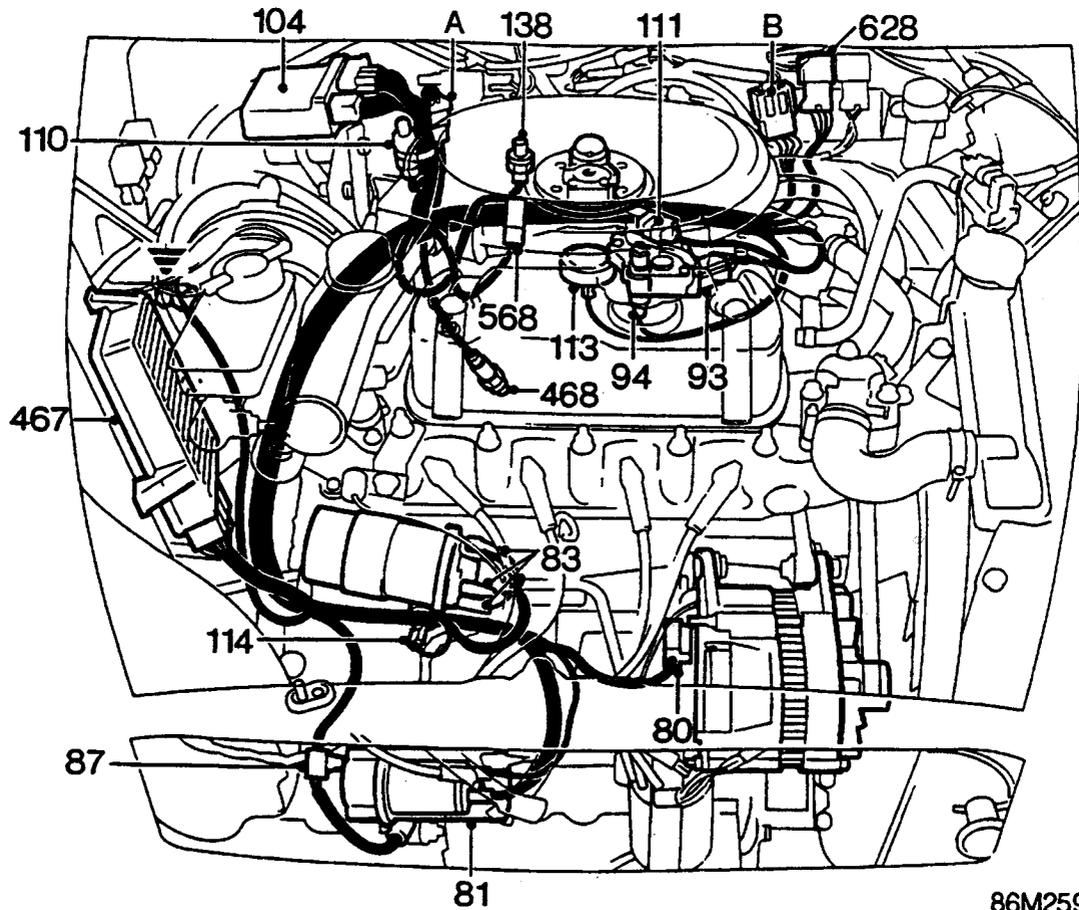

86M2594

Engine compartment harness

- 80 Alternator
- 81 Starter motor/Solenoid
- 83 Ignition coil
- 87 Crank shaft sensor
- 93 Throttle potentiometer
- 94 Coolant temperature sensor
- 104 Relay module
- 110 Diagnostic socket
- 111 Stepper motor
- 113 Manifold heater
- 114 Oil pressure switch
- 138 Inlet air temperature sensor
- 467 Modular engine management control unit
- 468 Oxygen sensor
- 568 Injector
- 628 Oxygen sensor relay

- A Oxygen sensor connector
- B Main harness connector

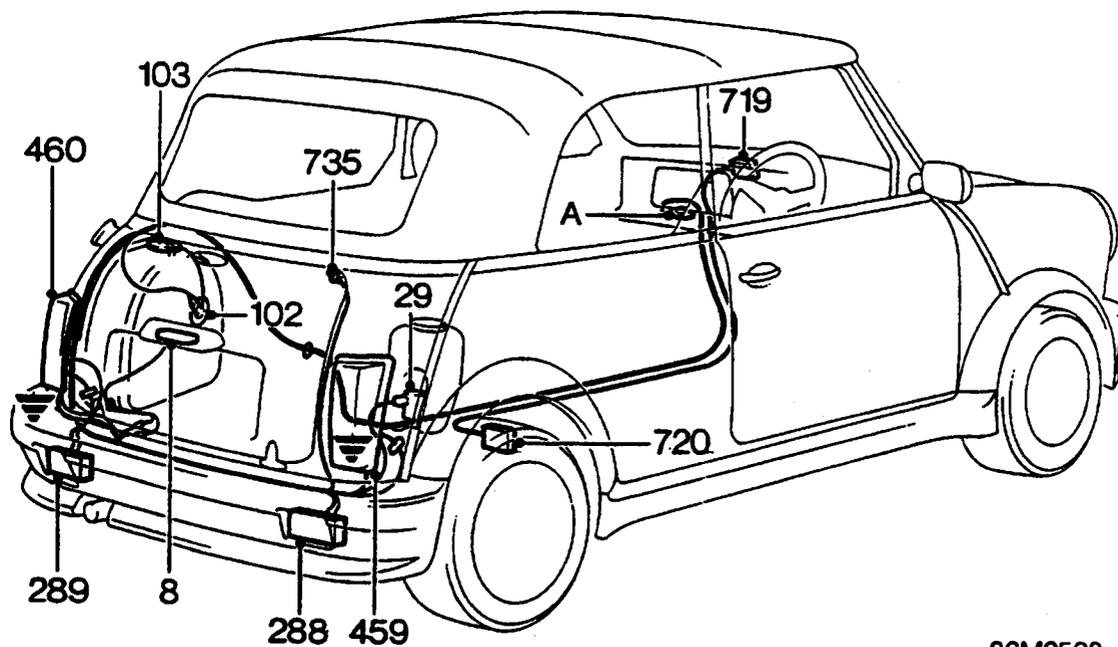

86M2598

Body harness

- 8 Number plate illumination lamps
- 29 Windscreen washer pump
- 102 Fuel gauge sender unit
- 103 Fuel pump
- 288 RH rear fog lamp
- 289 LH rear fog lamp
- 459 RH rear lamp
- 460 LH rear lamp
- 719 Anti - theft alarm control unit
- 720 Volumetric sensor
- 735 Boot switch

A Main harness connector

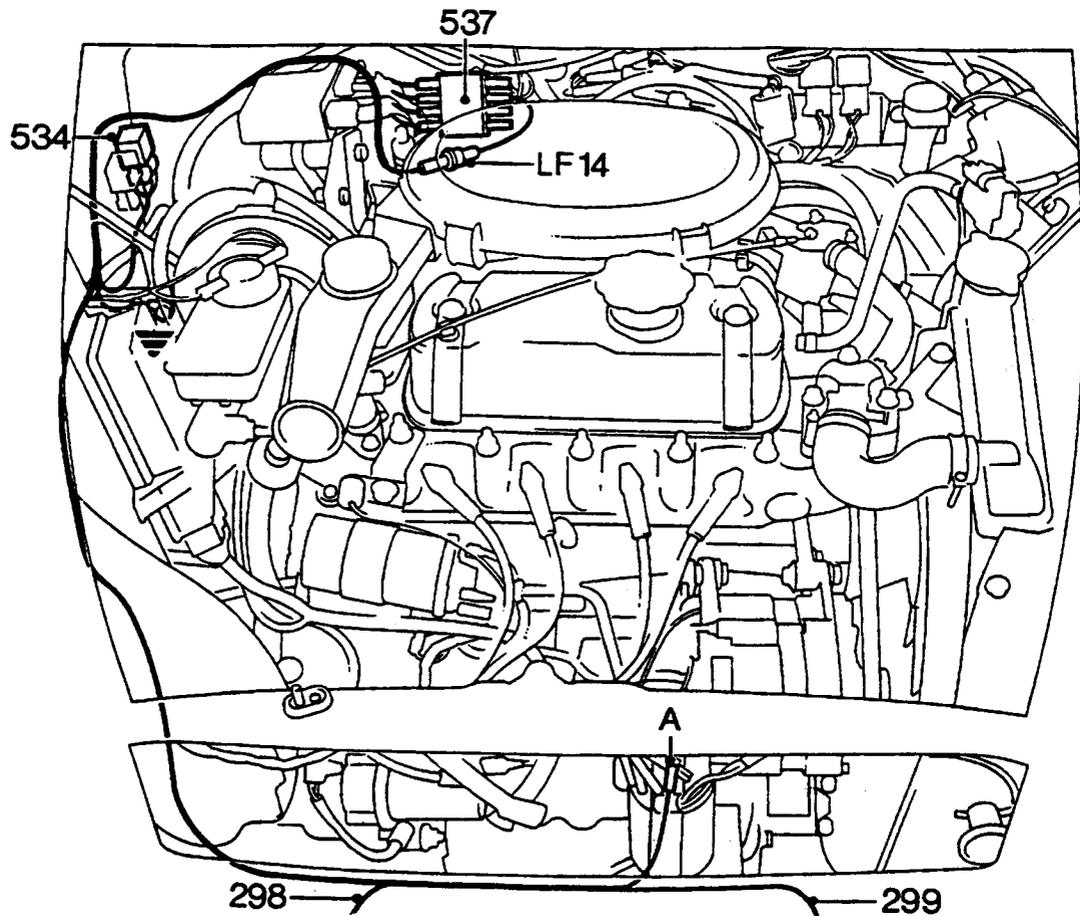

86M2593

Driving lamp harness

- 298 RH driving lamp
- 299 LH driving lamp
- 534 Relay module
- 537 Engine compartment fuse box

- A Main harness connector
- LF Line fuse 14

ELECTRICAL

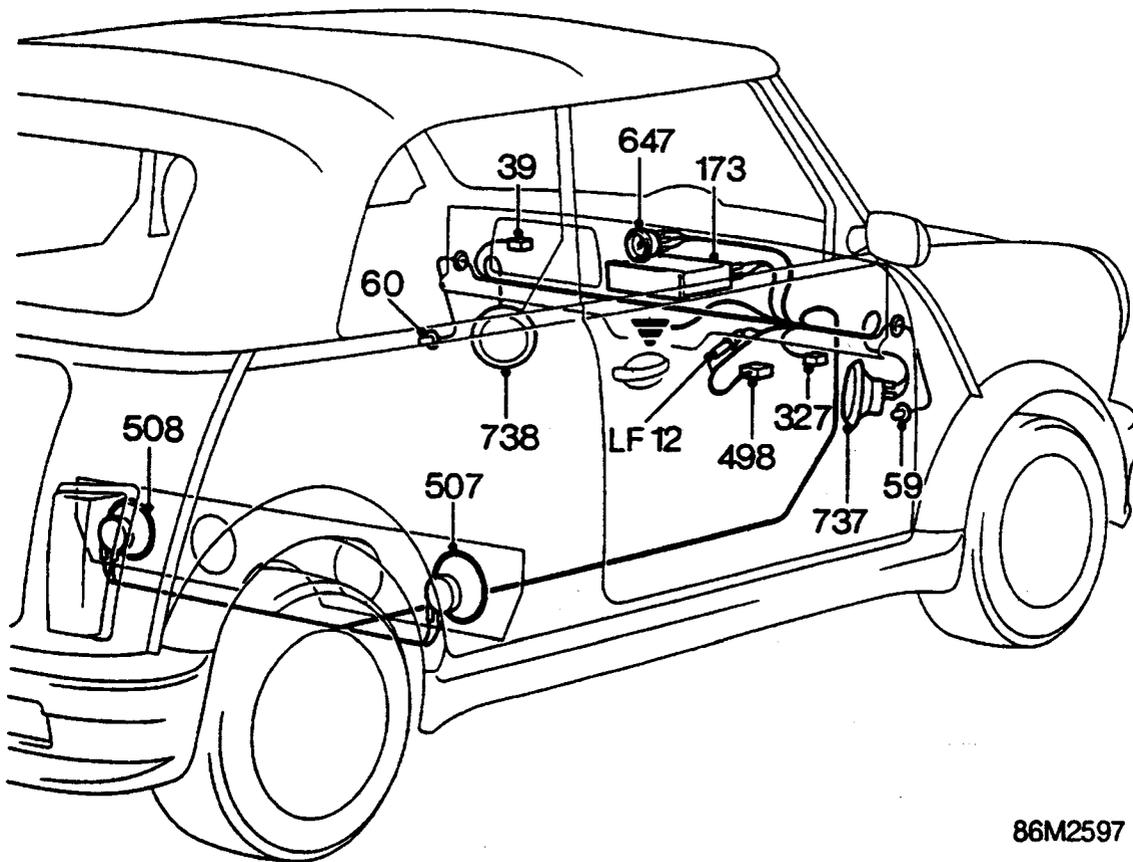

86M2597

Radio harness - Cabriolet models

- 39 Glove box lamp
- 59 Drivers door switch
- 60 Passengers door switch
- 173 Radio/Cassette player
- 327 RH footwell lamp
- 498 Main harness
- 507 RH rear speaker
- 508 LH rear speaker
- 647 Analogue clock
- 737 RH front speaker
- 738 LH front speaker

LF Line fuse

INSTRUMENTS

CONTENTS

Repairs	Page
Twin and triple instrument pack	2
Wooden fascia instrument pack	3
Analogue clock	3
Instrument pack printed circuit	4
Speedometer	5
Fuel and temperature gauges	6
Tachometer	7
Speedometer cable	8
Fuel gauge tank unit	9



INSTRUMENTS

TWIN AND TRIPLE INSTRUMENT PACK

Service Repair No. 88.20.19

Remove

1. Disconnect battery earth lead.

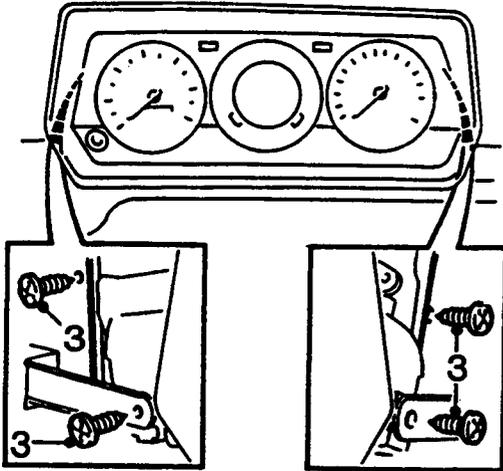

88M0041

2. Release bulkhead trim from both sides of instrument pack.
3. Remove 4 screws securing instrument pack to mounting bracket.
4. Pull pack away from mounting bracket for access to pack connections.

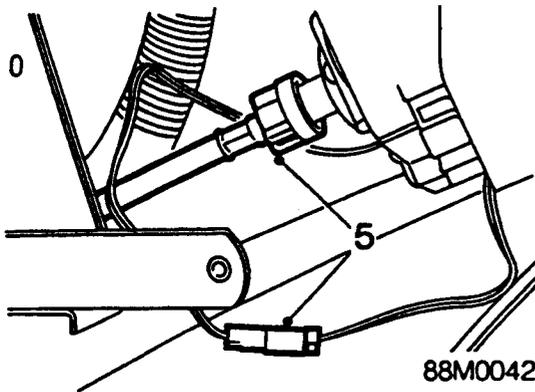

88M0042

5. Disconnect speedometer cable and alarm LED connector.

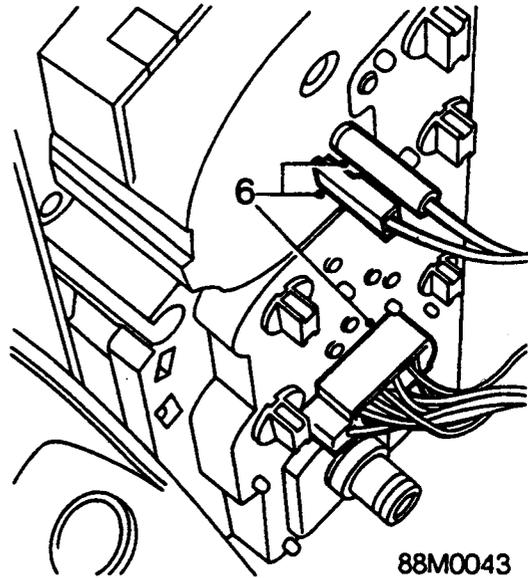

88M0043

6. Disconnect instrument pack multiplug and 2 leads from tachometer.
7. Remove instrument pack.

Refit

1. Position instrument pack to fascia.
2. Connect speedometer cable, instrument pack multiplug, tachometer leads and alarm LED connector.
3. Align instrument pack to mounting bracket, fit and tighten screws.
4. Refit bulkhead trim to instrument pack.
5. Connect battery earth lead.



WOODEN FASCIA INSTRUMENT PACK

Service Repair No. 88.20.01/99

Remove

1. Remove steering column assembly, see **STEERING**.
2. Remove fascia, see **Wooden fascia**.

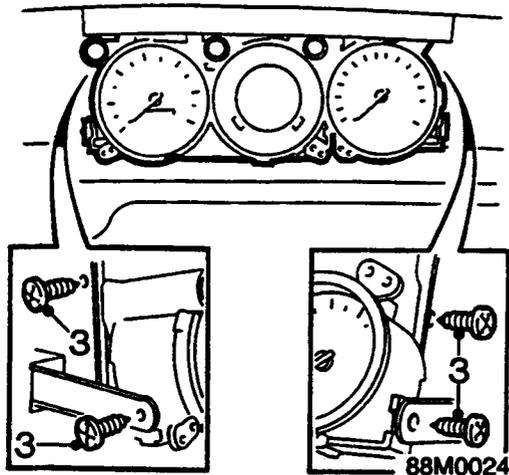

3. Remove 4 screws securing instrument pack.
4. Pull pack away from mounting bracket for access to pack connections.

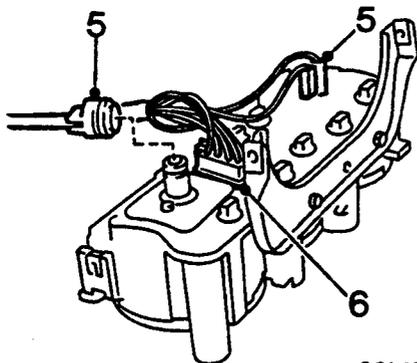

5. Disconnect speedometer cable and 2 leads from tachometer.
6. Disconnect instrument pack multiplug.
7. Remove instrument pack.

Refit

1. Fit instrument pack.
2. Connect speedometer cable and 2 leads to tachometer.
3. Connect instrument pack multiplug.
4. Align instrument pack with mounting bracket and fit and tighten 4 screws.
5. Fit fascia, see **Wooden fascia**.
6. Fit steering column assembly, see **STEERING**.

ANALOGUE CLOCK

Service Repair No. 88.15.07

Remove

1. Disconnect battery earth lead.
2. Remove radio, see **Radio/Cassette Player**.

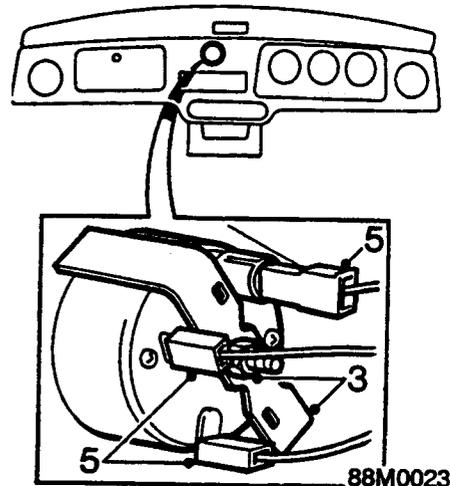

3. Remove nut and clock retaining plate.
4. Release clock and pull forward from the fascia panel.
5. Disconnect 3 lucars from clock.
6. Remove clock.

Refit

1. Connect 3 lucars to clock.
2. Fit and align clock to fascia.
3. Fit clock retaining plate and fit and tighten nut.
4. Fit radio.
5. Connect battery earth lead.

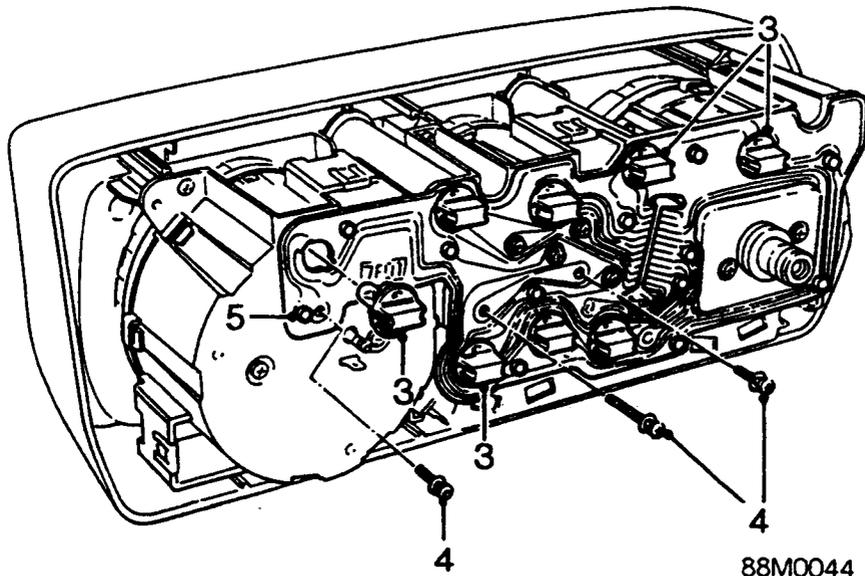

INSTRUMENT PACK PRINTED CIRCUIT

Service Repair No. 88.20.19

Remove

1. Disconnect battery earth lead.
2. Remove instrument pack,
Models with wooden fascia: See Wooden fascia instrument pack.
Models without wooden fascia: See Twin and triple instrument pack.
3. Remove 8 (7 on twin pack) warning and panel lamp bulb holders from instrument pack.
4. Remove 7 (6 on twin pack) terminal screws securing printed circuit to rear of instruments.
5. Release and remove printed circuit from studs on instrument pack.

Refit

1. Position printed circuit to instrument pack and secure to studs.
2. Fit and tighten terminal screws.
3. Fit warning and panel lamp bulb holders.
4. Fit instrument pack to vehicle,
Models with wooden fascia: See Wooden fascia instrument pack.
Models without wooden fascia: See Twin and triple instrument pack.
5. Connect battery earth lead.

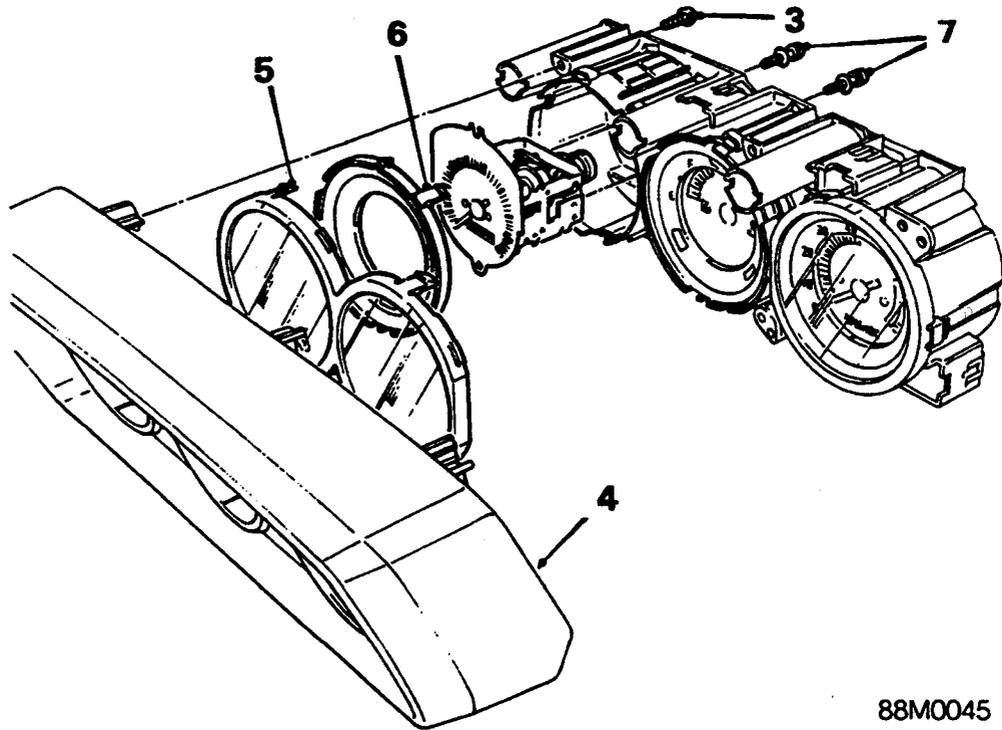

88M0045

SPEEDOMETER

Service Repair No. 88.30.01

Remove

1. Disconnect battery earth lead.
2. Remove instrument pack,
Models with wooden fascia: See Wooden fascia instrument pack.
Models without wooden fascia: See Twin and triple instrument pack.

Models without wooden fascia

3. Remove 6 screws (4 on twin pack) securing nacelle to instrument pack.
4. Remove instrument pack nacelle.

All models

5. Depress and release 4 transparent clips securing lens to instrument pack and remove lens.
6. Depress and release 3 black clips securing speedometer face plate to housing, remove face plate.

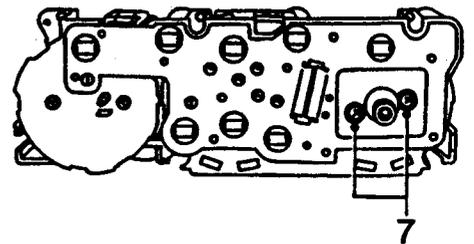

88M0046

7. Remove 2 screws and washers securing speedometer to housing
8. Remove speedometer assembly.

CAUTION: Damage to the damping mechanism will result if the speedometer is left laying face downwards.

Refit

1. Fit speedometer assembly to housing, fit and tighten securing screws.
2. Secure speedometer face plate to housing.
3. Secure lens to instrument pack.
4. *Models without wooden fascia:* Fit instrument pack to nacelle and secure with screws.
5. Fit instrument pack to vehicle,
Models with wooden fascia: See Wooden fascia instrument pack.
Models without wooden fascia: See Twin and triple instrument pack.
6. Connect battery earth lead.

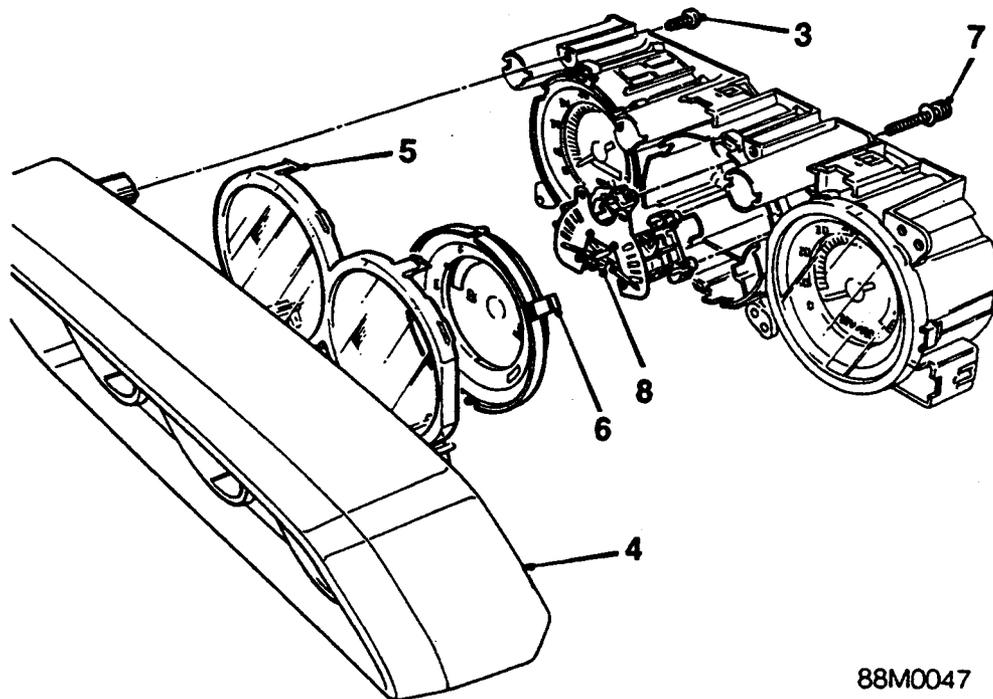

88M0047

FUEL AND TEMPERATURE GAUGES

Service Repair No. 88.25.14

Remove

1. Disconnect battery earth lead.
2. Remove instrument pack,
Models with wooden fascia: See **Wooden fascia instrument pack.**
Models without wooden fascia: See **Twin and triple instrument pack.**
3. Remove 6 screws (4 on twin pack) securing nacelle to instrument pack.
4. Remove instrument pack nacelle.
5. Depress and release 4 transparent clips securing lens to instrument pack and remove lens.
6. Depress and release 3 black clips securing instrument face plate to housing, remove face plate.

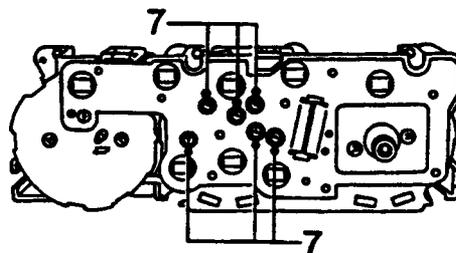

88M0048

7. Remove 6 terminal screws and washers securing gauge unit to housing
8. Remove temperature/fuel gauge unit.

Refit

1. Fit temperature/fuel gauge unit to housing, fit and tighten terminal screws.
2. Secure instrument face plate to housing.
3. Secure lens to instrument pack.
4. *Models without wooden fascia:* Fit instrument pack to nacelle and secure with screws.
5. Refit instrument pack to vehicle,
Models with wooden fascia: See **Wooden fascia instrument pack.**
Models without wooden fascia: See **Twin and triple instrument pack.**
6. Connect battery earth lead.

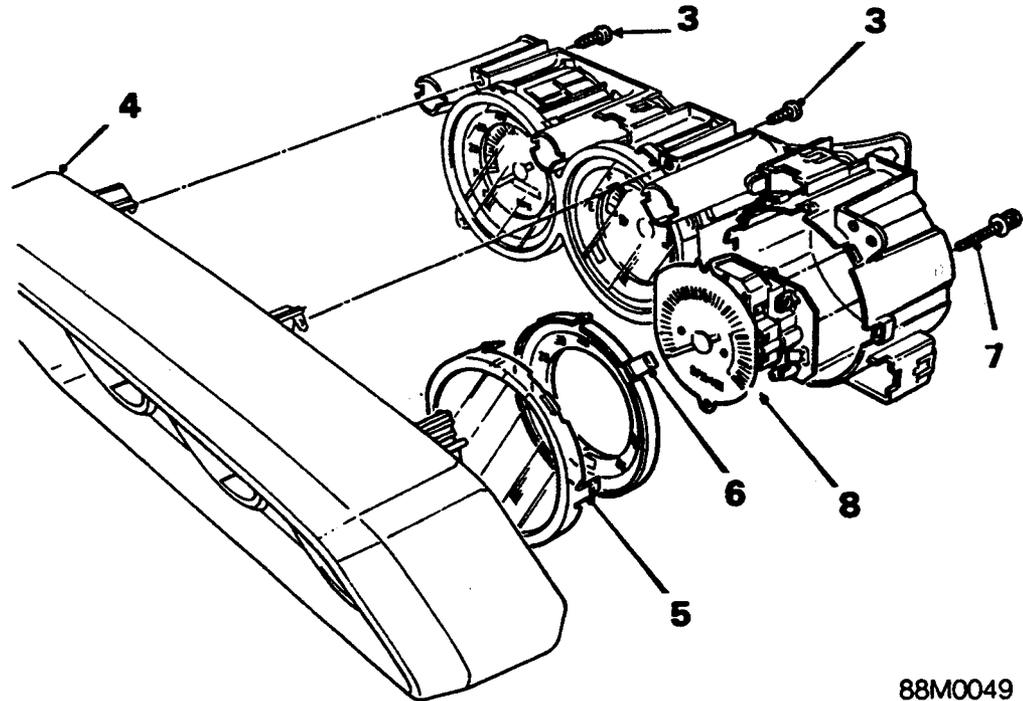

88M0049

TACHOMETER

Service Repair No. 88.30.21

Remove

1. Disconnect battery earth lead.
2. Remove instrument pack,
Models with wooden fascia: See **Wooden fascia instrument pack.**
Models without wooden fascia: See **Twin and triple instrument pack.**

Models without wooden fascia

3. Remove 6 screws (4 on twin pack) securing nacelle to instrument pack.
4. Remove instrument pack nacelle.

All models

5. Depress and release 3 transparent clips securing lens to instrument pack and remove lens.
6. Depress and release 3 black clips securing tachometer face plate to housing, remove face plate.

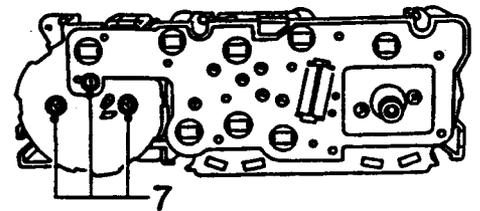

88M0050

7. Remove 3 screws and washers securing tachometer to housing
8. Remove tachometer.

Refit

1. Fit tachometer to housing, fit and tighten screws.
2. Secure tachometer face plate to housing.
3. Secure lens to instrument pack.
4. *Models without wooden fascia:* Fit instrument pack to nacelle and secure with screws.
5. Fit instrument pack to vehicle,
Models with wooden fascia: See **Wooden fascia instrument pack.**
Models without wooden fascia: See **Twin and triple instrument pack.**
6. Connect battery earth lead.

INSTRUMENTS

SPEEDOMETER CABLE

Service Repair No. 88.30.06

Remove

1. Disconnect battery earth lead.
2. Remove the air cleaner assembly, see **MAINTENANCE**.
3. Locate and disconnect speedometer cable from rear of instrument pack, access from underneath fascia.

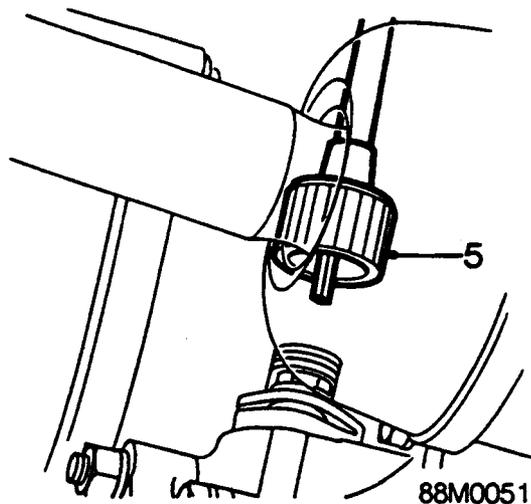

4. Raise front of vehicle.

WARNING: Support on safety stands.

5. Unscrew knurled nut securing speedometer cable to drive pinion on gearbox.

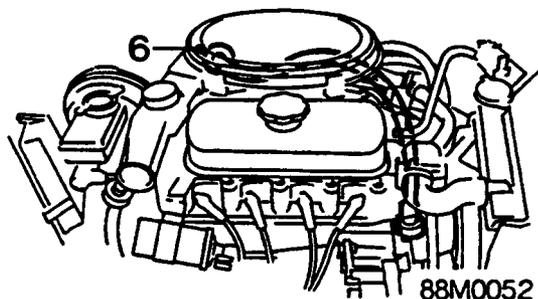

6. Release grommet from bulkhead.
7. Release cable from clip and remove from vehicle.

Refit

1. Fit cable to vehicle and secure grommet to bulkhead.
2. Engage speedometer cable to drive pinion and tighten knurled nut.
3. Ensure cable is routed correctly and that it is not kinked or twisted.
4. Secure cable to clip.
5. Connect speedometer cable to instrument pack.
6. Fit air cleaner assembly, see **MAINTENANCE**.
7. Connect battery earth lead.
8. Road test vehicle to ensure correct operation of speedometer.



FUEL GAUGE TANK UNIT

Service Repair No. 88.25.32

Remove

1. Disconnect battery earth lead.
2. Pump or syphon the fuel out of the fuel tank.

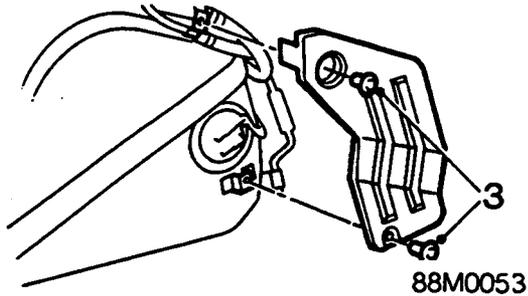

3. Remove 2 studs securing cover to tank and remove.

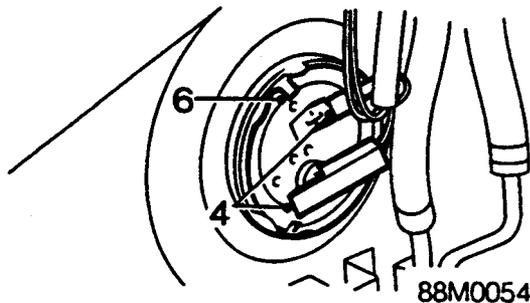

4. Disconnect 2 Lucars from fuel gauge tank unit.
5. Remove fuel tank, see **FUEL DELIVERY SYSTEM - Repairs**.
6. Using tool **18G 1001** unscrew the fuel gauge tank unit locking ring.
7. Remove fuel gauge tank unit and sealing ring.

Refit

1. Fit fuel gauge tank unit with new sealing ring.
2. Fit and tighten fuel gauge tank unit locking ring.
3. Fit fuel tank, see **FUEL DELIVERY SYSTEM - Repairs**.
4. Connect Lucars to fuel gauge tank unit.
5. Secure cover to tank with studs.
6. Refill fuel tank.
7. Connect battery earth lead.